



# NONRESIDENT TRAINING COURSE



April 1995

---

# Photography (Advanced)

NAVEDTRA 14208

## NOTICE

Pages 2-15 and 2-18 must be printed  
on a **COLOR** printer.

**Although the words “he,” “him,” and “his” are used sparingly in this course to enhance communication, they are not intended to be gender driven or to affront or discriminate against anyone.**

**DISTRIBUTION STATEMENT A: Approved for public release; distribution is unlimited.**

## PREFACE

By enrolling in this self-study course, you have demonstrated a desire to improve yourself and the Navy. Remember, however, this self-study course is only one part of the total Navy training program. Practical experience, schools, selected reading, and your desire to succeed are also necessary to successfully round out a fully meaningful training program.

**COURSE OVERVIEW:** In completing this nonresident training course, you will demonstrate a knowledge of the subject matter by correctly answering questions on the following topics: Basic Photojournalism; Photographic Quality Assurance; Electronic Imaging; Aerial Photography; and Supply and Logistics.

**THE COURSE:** This self-study course is organized into subject matter areas, each containing learning objectives to help you determine what you should learn along with text and illustrations to help you understand the information. The subject matter reflects day-to-day requirements and experiences of personnel in the rating or skill area. It also reflects guidance provided by Enlisted Community Managers (ECMs) and other senior personnel, technical references, instructions, etc., and either the occupational or naval standards, which are listed in the *Manual of Navy Enlisted Manpower Personnel Classifications and Occupational Standards*, NAVPERS 18068.

**THE QUESTIONS:** The questions that appear in this course are designed to help you understand the material in the text.

**VALUE:** In completing this course, you will improve your military and professional knowledge. Importantly, it can also help you study for the Navy-wide advancement in rate examination. If you are studying and discover a reference in the text to another publication for further information, look it up.

*1995 Edition Prepared by  
PHC(AW) Dale Freelan*

Published by  
NAVAL EDUCATION AND TRAINING  
PROFESSIONAL DEVELOPMENT  
AND TECHNOLOGY CENTER

**NAVSUP Logistics Tracking Number  
0504-LP-026-8530**

## **Sailor's Creed**

“I am a United States Sailor.

I will support and defend the Constitution of the United States of America and I will obey the orders of those appointed over me.

I represent the fighting spirit of the Navy and those who have gone before me to defend freedom and democracy around the world.

I proudly serve my country's Navy combat team with honor, courage and commitment.

I am committed to excellence and the fair treatment of all.”



# CONTENTS

<b>CHAPTER</b>	<b>PAGE</b>
1. Basic Photojournalism .....	1-1
2. Photographic Quality Assurance .....	2-1
3. Electronic Imaging .....	3-1
4. Aerial Photography .....	4-1
5. Supply and Logistics .....	5-1
 <b>APPENDIX</b>	
I. Silver Recovery .....	AI-1
II. Basic Operator Troubleshooting .....	AII-1
 <b>INDEX</b> .....	 INDEX-1

# **SUMMARY OF PHOTOGRAPHER'S TRAINING MANUALS**

## **PHOTOGRAPHY (BASIC)**

*Photography (Basic)*, NAVEDTRA 12700 consists of the following subjects: the principles associated with light, optics, cameras, light-sensitive materials, and equipment; still and motion-media shooting techniques; chemical mixing; image processing and printing; job control; and photographic finishing.

## **PHOTOGRAPHY (ADVANCED)**

*Photography (Advanced)*, NAVEDTRA 12701 consists of the following subjects: aerial photography; photographic quality assurance; electronic imaging; basic photojournalism; supply and logistics; silver recovery; and basic operator troubleshooting.

# INSTRUCTIONS FOR TAKING THE COURSE

## ASSIGNMENTS

The text pages that you are to study are listed at the beginning of each assignment. Study these pages carefully before attempting to answer the questions. Pay close attention to tables and illustrations and read the learning objectives. The learning objectives state what you should be able to do after studying the material. Answering the questions correctly helps you accomplish the objectives.

## SELECTING YOUR ANSWERS

Read each question carefully, then select the BEST answer. You may refer freely to the text. The answers must be the result of your own work and decisions. You are prohibited from referring to or copying the answers of others and from giving answers to anyone else taking the course.

## SUBMITTING YOUR ASSIGNMENTS

To have your assignments graded, you must be enrolled in the course with the Nonresident Training Course Administration Branch at the Naval Education and Training Professional Development and Technology Center (NETPDTC). Following enrollment, there are two ways of having your assignments graded: (1) use the Internet to submit your assignments as you complete them, or (2) send all the assignments at one time by mail to NETPDTC.

**Grading on the Internet:** Advantages to Internet grading are:

- you may submit your answers as soon as you complete an assignment, and
- you get your results faster; usually by the next working day (approximately 24 hours).

In addition to receiving grade results for each assignment, you will receive course completion confirmation once you have completed all the

assignments. To submit your assignment answers via the Internet, go to:

**<http://courses.cnet.navy.mil>**

**Grading by Mail:** When you submit answer sheets by mail, send all of your assignments at one time. Do NOT submit individual answer sheets for grading. Mail all of your assignments in an envelope, which you either provide yourself or obtain from your nearest Educational Services Officer (ESO). Submit answer sheets to:

COMMANDING OFFICER  
NETPDTC N331  
6490 SAUFLEY FIELD ROAD  
PENSACOLA FL 32559-5000

**Answer Sheets:** All courses include one “scannable” answer sheet for each assignment. These answer sheets are preprinted with your SSN, name, assignment number, and course number. Explanations for completing the answer sheets are on the answer sheet.

**Do not use answer sheet reproductions:** Use only the original answer sheets that we provide—reproductions will not work with our scanning equipment and cannot be processed.

Follow the instructions for marking your answers on the answer sheet. Be sure that blocks 1, 2, and 3 are filled in correctly. This information is necessary for your course to be properly processed and for you to receive credit for your work.

## COMPLETION TIME

Courses must be completed within 12 months from the date of enrollment. This includes time required to resubmit failed assignments.

## **PASS/FAIL ASSIGNMENT PROCEDURES**

If your overall course score is 3.2 or higher, you will pass the course and will not be required to resubmit assignments. Once your assignments have been graded you will receive course completion confirmation.

If you receive less than a 3.2 on any assignment and your overall course score is below 3.2, you will be given the opportunity to resubmit failed assignments. **You may resubmit failed assignments only once.** Internet students will receive notification when they have failed an assignment--they may then resubmit failed assignments on the web site. Internet students may view and print results for failed assignments from the web site. Students who submit by mail will receive a failing result letter and a new answer sheet for resubmission of each failed assignment.

## **COMPLETION CONFIRMATION**

After successfully completing this course, you will receive a letter of completion.

## **ERRATA**

Errata are used to correct minor errors or delete obsolete information in a course. Errata may also be used to provide instructions to the student. If a course has an errata, it will be included as the first page(s) after the front cover. Errata for all courses can be accessed and viewed/downloaded at:

<http://www.advancement.cnet.navy.mil>

## **STUDENT FEEDBACK QUESTIONS**

We value your suggestions, questions, and criticisms on our courses. If you would like to communicate with us regarding this course, we encourage you, if possible, to use e-mail. If you write or fax, please use a copy of the Student Comment form that follows this page.

## **For subject matter questions:**

E-mail: n313.products@cnet.navy.mil  
Phone: Comm: (850) 452-1001, Ext. 2167  
DSN: 922-1001, Ext. 2167  
FAX: (850) 452-1370  
(Do not fax answer sheets.)  
Address: COMMANDING OFFICER  
NETPDTC N313  
6490 SAUFLEY FIELD ROAD  
PENSACOLA FL 32509-5237

## **For enrollment, shipping, grading, or completion letter questions**

E-mail: fleetservices@cnet.navy.mil  
Phone: Toll Free: 877-264-8583  
Comm: (850) 452-1511/1181/1859  
DSN: 922-1511/1181/1859  
FAX: (850) 452-1370  
(Do not fax answer sheets.)  
Address: COMMANDING OFFICER  
NETPDTC N331  
6490 SAUFLEY FIELD ROAD  
PENSACOLA FL 32559-5000

## **NAVAL RESERVE RETIREMENT CREDIT**

If you are a member of the Naval Reserve, you may earn retirement points for successfully completing this course, if authorized under current directives governing retirement of Naval Reserve personnel. For Naval Reserve retirement, this course is evaluated at 9 points. (Refer to *Administrative Procedures for Naval Reservists on Inactive Duty*, BUPERSINST 1001.39, for more information about retirement points.)

## Student Comments

**Course Title:** Photography (Advanced)

**NAVEDTRA:** 14208 **Date:** \_\_\_\_\_

**We need some information about you:**

Rate/Rank and Name: \_\_\_\_\_ SSN: \_\_\_\_\_ Command/Unit \_\_\_\_\_

Street Address: \_\_\_\_\_ City: \_\_\_\_\_ State/FPO: \_\_\_\_\_ Zip \_\_\_\_\_

**Your comments, suggestions, etc.:**

<p><b>Privacy Act Statement:</b> Under authority of Title 5, USC 301, information regarding your military status is requested in processing your comments and in preparing a reply. This information will not be divulged without written authorization to anyone other than those within DOD for official use in determining performance.</p>
--

NETPDTC 1550/41 (Rev 4-00)



## CHAPTER 1

# BASIC PHOTOJOURNALISM

Photojournalism is a merger of still photography and written language into a coherent communication medium. The Navy photojournalist is a reporter who uses a camera and written text to convey a message to the intended audience. This message is usually spread by newspapers, magazines, and other publications. Photographs and words used together can provide a complete and accurate report of an event or story. Some events that occur in the Navy are planned far in advance so you have plenty of time to prepare for the assignment. Other events unfold quickly and dramatically and afford little or no preparation. Stories range from the obvious to those that are created with a considerable amount of imaginative work by a photojournalist. The foremost requirements for a successful photojournalist are to master the equipment and have the equipment ready to use. You cannot concentrate on an assignment if you are trying to learn how to use a camera. An important event will go unrecorded when you are fumbling and assembling equipment.

A photojournalist must use imagination to accomplish an assignment. Not all assignments have a great inherent human interest value, and the less spectacular the subject matter, the more important the photojournalist's imagination becomes. Often, a novice photojournalist misses good photographs because of a lack of aggressiveness. Frequently, Navy photojournalists are tasked to photograph notable personalities of diversified backgrounds. Always respect your subjects, regardless of who they are, but never feel inferior.

The assignments of a Navy photojournalist can be divided into two groups:

- Spot news
- Feature pictures

Spot-news photography denotes coverage of current news events and has a strong requirement of immediacy. What happens today of importance should be recorded and reported as soon as possible.

Conversely, a feature assignment should emphasize the human interest aspect of an event or story and ideally be as interesting to an audience next year as today.

A sharp dividing line does not separate spot-news photographs from feature photographs. In fact, most spot-news events can provide feature possibilities. Likewise, some feature stories may have strong spot news appeal. A good photojournalist should always consider possible "spin-off" stories that may exist.

### SPOT NEWS

Spot news is an event that happens without warning and, in many ways, is the most difficult event to photograph—an accident, a plane crash, a fire or tornado—even the unexpected arrival of the CNO aboard your ship. Regardless of the situation, you will be working at top speed and under the pressure of a deadline. Success of your photography is dependent upon how well you handle your equipment, arrange your time, and do your research. Most experienced photographers agree that spot-news photography is one of the most difficult and nerve-shattering assignments. Why is that? It is perhaps the very nature of what the photographer is faced with, rapid occurring events, little time, and the need to "get the news out."

A spot-news photograph is used to relate a story about a significant event to the public in a direct, straightforward, factual, and realistic manner while the event is still newsworthy. The spot-news photograph often shows conflict, tragedy, or emotion. It is not possible to do the research before you begin shooting; you will already be involved in getting the photos. Ask questions afterwards. See the official at the scene; obtain names and other pertinent information. Remember to get a telephone number or address of anyone connected with the situation. It may become necessary to obtain additional information at a later time. Because of the excitement or emotion involved, the possibility of getting erroneous information is greater at the scene than it is afterwards (fig. 1-1).



PARENTS WITNESS THE OFFLOADING OF THEIR SON'S BODY AS A MARINE CAPTAIN SALUTES A FALLEN COMRADE.  
*Jim Bryant*



FIREFIGHTER HUGS THE FLOOR AS HE ESCAPES THE FLAMES OF A BURNING BUILDING.  
*Mike Slover*

**Figure 1-1.—Spot-news photographs.**

Your control over the subject is generally limited to the camera angle and the instant of exposure. A selection of lenses and your technical skills should make the job easier. You are expected to move around your subject shooting from all sides to get complete coverage, including long, medium, and closeup views. You are obligated to relate to the

reader those events of a spot-news nature. You should do this faithfully without artistic interpretation and faking. Your reader wants to know what happened, so show him. Do not tell a fairy tale. This does not mean that you are restricted to only a 50mm normal lens and one type of film. If a super-wide lens heightens the dramatic effect without destroying



the facts, then use it. When a long lens lets you close the gap between you and the event and obtain facial expressions and body gestures, then by all means use it. Just remember, those ideas must add to and be a faithful part of the event you covered.

In covering a spot-news assignment, your responsibility is to provide photographs complete with captions as rapidly as possible. This helps to ensure that a release is made while the event is still news. Plan ahead. Keep your deadline in mind. Work rapidly but accurately. Your enemy is time. Arrange your time so you do not overshoot the deadline. The boss, editor, or public affairs officer (PAO) expects to use that photo and caption the minute it is dried. "Nothing is as dead as yesterday's news."

Each spot-news photograph should have the following elements:

- Newsworthiness and/or human interest value
- Impact
- Photographic quality
- Accurate written information on the subject matter

### **NEWSWORTHINESS AND/OR HUMAN INTEREST VALUE**

When a photograph does not have news or human interest value, the chance of the photograph being published is slim. Human interest value is almost impossible to measure. The best indicator to determine whether a photograph has human interest is your own emotions. When the photograph affects your emotions or arouses your curiosity, it most probably will do the same for other people.

### **IMPACT**

The emotional stopping power of a photograph is "impact." Impact in a photograph should produce some kind of emotional shock to the viewer. There are no rules for consistently producing photographs that have impact. To create impact, a photographer should be sensitive toward the subject matter and be able to feel the emotion that you intend to convey to a viewer. The difference between photographs with

and without impact is usually determined by whether the photographer reacted emotionally to the subject matter or was indifferent and took the picture as just another assignment. Most subject matter does not have inherent impact. Therefore, you, as the photojournalist, must often create it. Impact can be created through cropping, recording peak action, composition, contrasting subject matter, and other photographic techniques.

### **PHOTOGRAPHIC QUALITY**

The news photograph should tell a story and the subject matter should be identifiable. This is not to say that the image must always be sharp and without grain. (This does not mean you can be careless in your work.) These "imperfections" sometimes enhance a photograph and, depending on the subject matter, can provide impact. In news photography, you may not have control over the position of the subject matter, lighting, or even your own position. It is possible that the action of an event may unfold so rapidly that the only choice you have is to aim the camera and shoot. Thus the only control you may have is the instant that you take the exposure. Although the ideal scene conditions may not exist, your film may be the only record of an event. To return from a news assignment without recording the event because of undesirable scene conditions is gross neglect of duty.

Whenever possible, fill the film format with the subject matter. You can do this by either moving farther from or closer to the scene or by using lenses with different focal lengths. Vary the camera angles and do not stand in one position using the same focal-length lens to shoot an entire assignment.

For reproduction purposes in a newspaper or magazine, a photograph should have normal contrast, contain a good range of intermediate tones, and be printed on a glossy-surface paper. When a photograph has large shadows or highlight areas, image detail may be lost in these areas when the photograph is reproduced.

Editors of publications think in terms of column width for photograph size. Column width in a newspaper is about 2 inches; therefore, when you compose news photographs for publication, keep this dimension in mind. A photograph should be croppable so it fits into one or more full columns.

## ACCURATE INFORMATION

A vital part of a news assignment is the written information that accompanies the photographs. Excellent photographs with tremendous impact could go unused if you do not provide adequate identifying information. Take a notebook with you on each assignment and write down information to answer the following questions:

- What was the event that took place?
- Who was involved in the event? Write down the names in correct order (from the left) as the people appear in the photograph. Do not hesitate to ask for correct spelling of people's names. Titles or positions of people should also be obtained.
- Where did the event take place?
- When did the event take place? Write down the time and date.
- Why did the event take place?
- How did the event take place?

When these questions are answered, a news photograph has adequate accompanying identification.

## FEATURE ASSIGNMENTS

Feature assignments and accompanying text can be divided into categories of feature picture, picture sequence, picture story, and picture essay.

Because speed in publishing a feature assignment is not usually a critical factor, a more in-depth report of an event or story is possible. Ideally, before starting a feature assignment, you should compile a shooting script. A shooting script is a written guide for planning the coverage of a story. The picture ideas in a shooting script are ideas only. They should not repress the photographer shooting photographs. Seldom are the ideas in a script identical to the actual photographs. A script allows you to previsualize an entire feature story. Important aspects are emphasized because you have already pinpointed the main features you plan to cover. To plan an effective shooting script, you must research the subject matter thoroughly.

Research is gathering facts on the history, present-day proceedings, and intended projections of the subject matter that you plan to feature. This may involve trips to the library, checking your own files, interviewing people, and so on. It is difficult to create a picture story that stirs emotions when you know nothing about the subject. With research, you should acquire an insight on the subject that helps you to present an effective in-depth story.

On any assignment, you should be aware of potential "spin-off" stories. Concentrate on the assignment for which you were tasked, but write down ideas or "leads" to new stories.

## FEATURE PICTURE

A feature picture is a single picture that tells a story. It could be a color or black-and-white print or a transparency. It is quite possible that the end product will be used in the print media, in the electronic media, as an advertisement (recruiting, for example), as a news feature, or for photographic exhibition.

A feature picture serves a single purpose—to tell a story quickly and clearly. A "feature picture" is defined as any picture, other than instantaneous news, that informs, entertains, or provokes a reaction or response.

The goal of a feature picture is to communicate. Without the power to communicate an idea or feeling, the finest quality print and prolonged hours of work are reduced to a mere sheet of photographic paper. Whether it is your goal to become an artist, technical photographer, or photojournalist, the finished product must be of professional quality. It is this quality that helps transmit the message that you worked to produce.

No doubt, the feature photos that inform are the most common. This is the photo you see on the front page of a newspaper, the one that shows Miss America receiving her crown, or the flooded Mississippi River as it overflows its banks. These are informative pictures that have lost some of the hurry-up, rush-rush of a hard (straight) news photo.

When a feature picture is used to entertain, it usually depicts the lighter side of life. It does not require the full attention of the reader to get the message; for example, children and animals in funny

situations, such as a small boy trying to give a St. Bernard a bath in a washtub. Just the idea conjures up images of soap and water everywhere. This is the kind of photograph that is explicit, and when the quality is good, it transmits the message effortlessly.

A feature picture can be used to provoke an action, to excite someone, or to create a feeling. Here the message is strong and emotional. The photographer has a particular feeling he or she wishes to bring out in the reader. This is the type of picture that moved Congress to pass laws prohibiting child labor (fig. 1-2).

## **Research**

Defining a feature picture is fundamental; the process you will find complicated is researching the subject. Once the originator of an assignment provides the photographer with an idea of the kind of pictures desired, it is up to you, as the photographer, to perform the necessary research.

The photographer should ask the following questions: "What are the requirements of the assignments? What is the end product going to be—black-and-white or color, prints, or transparencies? What are the size requirements of the pictures, as well as in what publication, if any, will they be used? Where is each photograph to be used—as a cover by itself or in connection with other photographs for a story? Will the prints be used in an exhibition or placed on display somewhere"?

Only through research can you answer the many questions pertaining to the assignment. Thorough research will provide the necessary details you need to plan the shooting and to bring together all the necessary elements of the photographs.

## **Making Feature Pictures**

Making feature pictures may require elaborate technical effort and unusual compositions, yet it may be simple. When you produce feature pictures, you must work carefully and take time to consider and evaluate your approach. Unlike a news assignment, a feature picture assignment permits you to exercise more control over the situation. You are better able to control the subject, lighting, and composition.

To be a good photojournalist, you must use correct composition to make the message clear that

your picture is meant to get across. The position of the subject, the highlight and shadow areas, the use of leading lines, and the foreground and background must be controlled to best tell the story. When the picture elements are arranged, you must think of what is included, what is missing, and what is suggested.

To dramatize an idea for a feature picture, you have many tools to work with. Knowing your subject and subject selection are significant. Imaginative lighting can be used to create a mood. Many photographers take full advantage of fast lenses and fast film to use available light.

For a feature picture to have more impact, you may find it necessary to distort or accentuate the perspective with various focal-length lenses. The camera position is also important. You can use a distant panoramic shot to set the scene and a closeup shot to emphasize significant detail. Shooting from a low camera angle adds stature to the subject. A high camera angle creates a sense of separation; it shows more of what is happening.

The control you exercise over the scene can add interest and variety to feature pictures. Electronic flash and fast-shutter speeds can "freeze" action and "stop" what is too fast for the eye to see. By using the right application of slow-shutter speeds, you can blur moving objects, giving an illusion of movement to your pictures. Time exposures of moving lights create motion patterns, as does panning the camera with the subject. The serious photojournalist also skillfully controls depth of field.

## **Picture Quality**

For publications, you want to deliver the best full-toned, normal print to the printer that is possible. This means that the print must have full highlight and shadow detail. The print must be of proper density, never so light or so dark that it loses detail. Contrast should always be normal, unless the subject matter requires higher or lower contrast. Printing in a newspaper, book, or magazine tends to increase the contrast of a photograph; and it often becomes darker. A display print, on the other hand, is viewed directly and does not go through the lithographic process. But, here again, the best possible print must be made with detail in highlights and shadows. It must have proper contrast and density and be dust- and spot-free. It is important for you to know how the photograph is going to be viewed

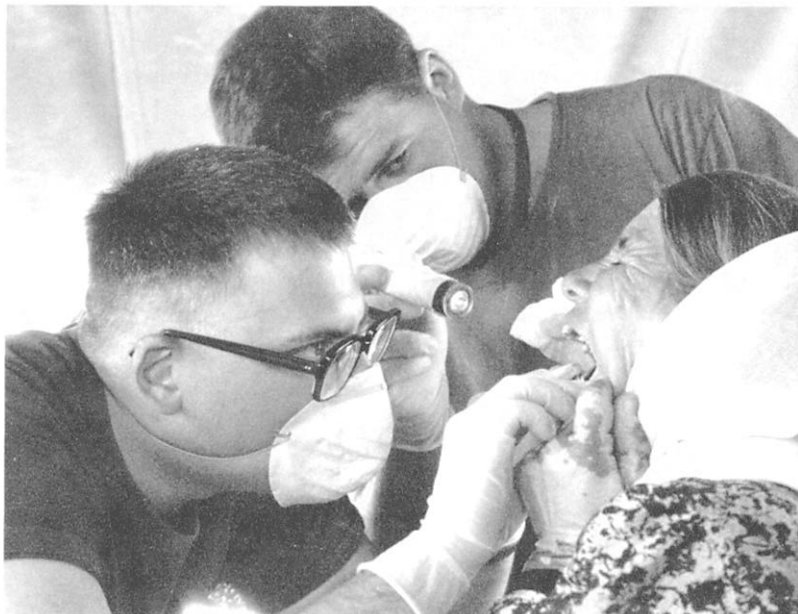

*JOC Gary H. Potterfield*



*PHCS Ron Bayles*



*LCDR Skip Burdon*

**Figure 1-2.—Feature pictures**



*PH3 Jeff Elliott*



*PH2(AC) Mark Hettenhofen*



*PHCS Ron Bayles*

**Figure 1-2.—Feature pictures—Continued.**

Oftentimes, a display print is viewed under lights that are much brighter than usual. When you view a print under normal room light, it looks fine; but when you view the same print under a brighter light, it may look flat and washed out. This is because the additional light being reflected from all areas of the print causes the dark areas to look lighter and the light areas to look brighter (with some loss of detail). The overall effect is a flat, washed-out print. You can remedy this by printing the display print slightly darker than you would consider normal - once again, normal contrast with detail in the highlights and shadows, but slightly darker.

### Mounting Display Prints

Photographers categorize their work with that of an artist or scientist, meaning they see photography as either an art or a science. No matter what school of thought you hold, it should still be your goal to have your prints viewed, appreciated, and most importantly, communicate your message. This is the reason that the salon mount came into use. In photography, this means a display print that is mounted for exhibition.

To mount display prints, you should begin by selecting a mounting board 2 to 4 inches larger than the print size. Your selection of color should

compliment the photograph. Thickness of the board, of course, is optional.

The preferred placement of prints for salon mountings is near the OPTICAL CENTER. This allows for pleasant placement of the photograph as well as room for the photographer's name and print title below the print. The steps for mounting prints are as follows (fig. 1-3):

1. Place the print in the upper left-hand corner of the mount with its top right and lower left corners falling at points A and B, respectively.
2. Divide the remaining space (point A to C) in half to locate point D, then draw a light pencil line (point D to E) parallel to the edge of the mount. Do the same with the bottom portion of the mount (point G to I).
3. Draw line BI. The intersection of this line with line DE gives point J.
4. Mount the print with its right edge on line DE and the lower right corner on point J.
5. The print is now at the optical center of the mount. Now place the photographer's name and title below the photograph.

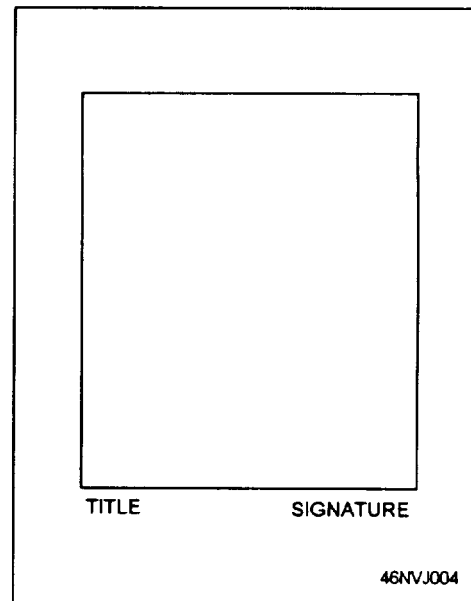
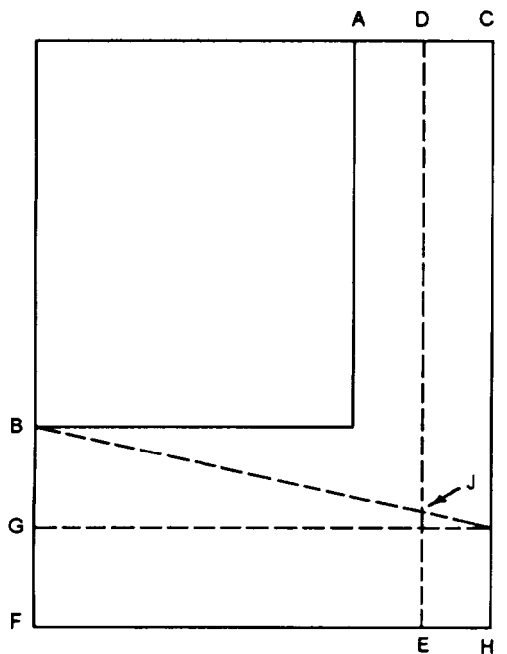

Figure 1-3.—Print mounting.

6. Erase all pencil lines.

## **PICTURE SEQUENCE**

A picture sequence is a series of photographs dealing with one subject. It may tell a story, present an event, describe a scene, reveal a person, or show how to do something. A common use for a picture sequence is depicting a person during an interview. The most successful picture sequences create several visual images that contain emphasis and action.

When you are producing a picture sequence, remember, film is a relatively cheap commodity. It is foolish for you to feel restrained by the amount of film you use. A virtue of the 35mm camera is that a series of 36 exposures can be made in rapid succession to record many expressions that may be edited later.

Picture sequences are categorized according to their method of production as follows:

1. **FIXED CAMERA AND SUBJECT.** An example of this type of sequence is the photographic interview where the cameraperson and the subject remain in their respective positions throughout the picture session.

The use of a long lens is almost a necessity for this type of sequence. A long lens permits you to be far enough away that you will not disturb the subject; yet it can produce large images (usually head and shoulders) or close-ups.

2. **FIXED CAMERA, SUBJECT MOVES.** Picture sequences of this type are often used in sports photography where the action moves up and down the field of play while you are confined to your seat. This type of sequence is also used for photographing events, such as a parade, as it passes by. You may be in the reviewing stand or even on the roof of a nearby building.

3. **SUBJECT FIXED, CAMERA MOVES.** This approach to sequence photography often presents the subject in a more interesting way. It is used to show different aspects of the subject, such as several angles of an aircraft or a building. It adds variety and interest to the series.

4. **CAMERA AND SUBJECT MOVE.** This is the most dramatic sequence and allows you to use

your imagination to the fullest extent. But it also requires you to follow the action physically. For example, this type of sequence may be used to show a pilot being rescued from his burning aircraft by a crash crew. The first picture shows the crash crew getting into their fire fighting turn-out gear. Picture number two shows the fire trucks approaching the burning plane. The third picture shows one of the fire fighters freeing the pilot from the wreckage. The fourth picture shows first aid being administered to the injured pilot. The final picture in the sequence shows a doctor treating the pilot in an emergency room. In producing this sequence, you must shoot many exposures and then edit them down to those that are most effective.

Finally, a picture sequence requires continuity that may be created by subject action, by photographic technique, or by an event (fig. 1-4).

## **PICTURE STORY**

The production of a picture story is one of the most exciting and challenging assignments in photography. It is an effective method of telling a story about events that are happening in the Navy. However, a picture story does not just happen; it starts with an idea. This idea forms the foundation upon which a story is built. When the idea is sound and you provide good photography, there is an excellent chance of developing a professional picture story.

Regrettably, the development of a picture story is a major stumbling block for many photographers. All too frequently you hear the comment, "There is nothing in my command to do a picture story on." This is an unfortunate attitude. Navy men and women are surrounded by a wealth of picture-story material; look around! The sea, ships, and ships' crews have fascinated people for years. Unfortunately, most Navy people take their environment for granted.

To the non-photojournalist, a picture sequence is sometimes confused with a picture story. A picture sequence is a group of loosely related photographs that provide the reader with only a few miscellaneous impressions of an event. The picture story, on the other hand, is a complete unit that has been planned, researched, and supported by written text and captions. It is the account of an interesting and significant event, personality, idea, or other aspect of contemporary life. In a picture story, the photographs and text support each other. There are several types

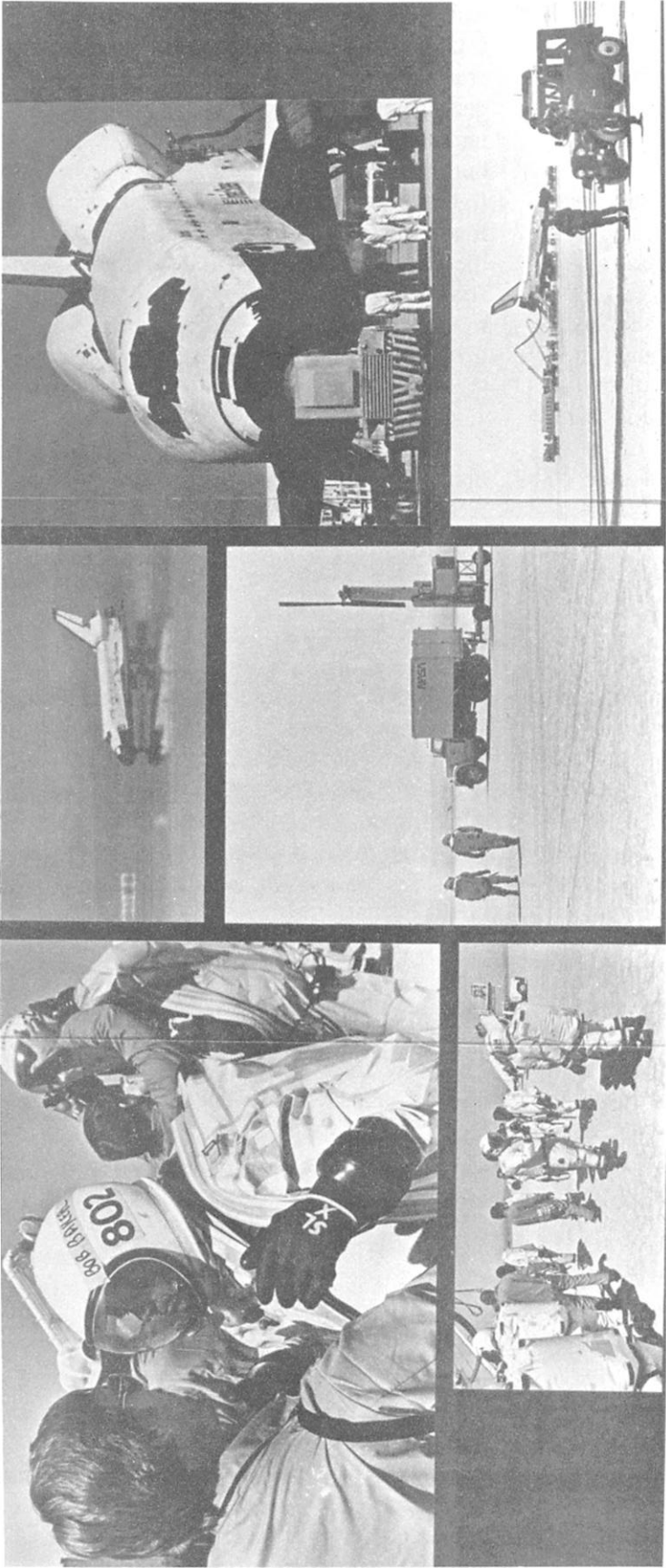

**Figure 1-4. — Picture sequence.**



of picture stories, but the two most often used are the *Illustrated Text* and the *Picture-Text Combination*. With the *Illustrated Text*, emphasis is placed on the text with photographs used to support the words. In the *Picture-Text Combination*, the story is told primarily through pictures and the words support the pictures.

Planning is essential in the production of a picture story. You should plan your photographic coverage so the finished story shows the professional news touch. When you want this quality in your picture story, coverage techniques should include the following: researching the subject and establishing a good relationship; selecting equipment (camera, lens(s), lighting, film) that is best suited for the job; anticipating the improbable and having an alternate plan available; keeping your pictures from looking posed; moving in on the subject and making your pictures show the desired action; using a shooting script; having self-confidence; ensuring complete coverage by shooting both left- and right-facing photographs, long shots, medium shots, and close-ups, as well as both vertical and horizontal views. Picture stories do not appear in print by accident. They are the result of careful planning, thorough research, and execution. The development of a picture story is carried out in six well-defined steps as follows:

1. **DEVELOPING THE IDEA.** All picture stories begin with an idea. Whenever you cannot find picture-story material, you are admitting that you are not very alert, observant, or curious. Wherever you go, there are more story ideas than you could possibly find the time to do. You can get ideas for picture stories by subjecting yourself to stimulating experiences, talking to other people, and observing situations- both your own and those related to you by others.

2. **RESEARCHING THE SUBJECT.** After developing an idea for a picture story, you are ready to research the subject. Research is one of the most important parts of doing a picture story. Before you start shooting, you need to learn as much as possible about the place, situation, object, and people involved. The more complicated the story, the more research you need to perform. No matter what form the research takes, remember one very important thing-**YOU CANNOT PERFORM ALL YOUR RESEARCH SITTING AT A DESK.** You must leave the shop, talk to people, see the subject. While no two people perform research in exactly the same manner, the following guidelines are recommended:

a. Contact the person in charge of whatever or whomever you intend to do the story on, and explain your story idea.

b. Obtain the name and phone number, work schedule, and background information on each person involved in your story.

c. Observe the operation without interfering and make notes on picture possibilities.

d. Stay with the subject(s) until you are fully satisfied that you can anticipate their next move or work step; watch the subject(s) for facial expressions, gestures, and observe them during coffee breaks, and so on.

e. Anticipate a sudden departure from the usual and be prepared to cope with it.

f. Conduct interviews with the subject(s), their peers, subordinates, and seniors. Whenever possible, shoot the photographs at one session and conduct the interview at another.

3. **PLANNING THE TREATMENT.** The "treatment" is an arrangement of facts you have collected; this includes the type of pictures you require to convey the theme or purpose you have in mind adequately. Plan your pictorial coverage. Decide what elements of the story should be presented verbally, and what elements should be presented visually.

Because each picture story is somewhat different, you cannot follow the same pattern for each assignment. There are, however, certain planning criteria upon which all picture stories are based. The planning criteria is as follows:

a. **INTEREST.** The readers must gain something from the story or they are not going to read it.

b. **PICTURE IMPACT.** It must appeal to the eye, create curiosity, and hold the viewer's attention.

c. **SCOPE.** The picture story of a ship is possible but difficult; a department within the ship is a little less difficult; a division within the department is even less difficult; one person within the division is comparatively simple. By narrowing the scope and

focusing on one person, you can still tell the story of the ship, the department, and the division.

d. **FOCUSING ON PEOPLE.** Whatever the story, chances are it can be made better and more interesting when it is told in terms of people doing something. Of course, it is possible to focus on an inanimate object, such as an airplane, but readership tests indicate that people are interested in people.

e. **UNIVERSAL APPEAL.** Before your picture story can appear in a newspaper or magazine, it must appeal to a large number of people.

4. **PREPARING THE SHOOTING SCRIPT.** To begin shooting a picture story without an idea of what you are trying to accomplish is a real gamble. The shooting script is a record of your ideas—a blueprint from which you build the story. But remember, your shooting script is a guide only, and it should be flexible to some degree.

A shooting script should answer the following questions regarding a picture story:

- WHO:** The name of the individual or subject to be photographed. His or her job title and duty responsibilities should be included.
- WHAT:** The exact nature of what subject action is to be performed in support of the overall theme of the picture story.
- WHEN:** The time and date when the subject is to be photographed. Ensure the subject is available at the time specified.
- WHERE:** The exact location(s) where the photography is to take place.
- WHY:** The reason(s) why this story should appeal to a given audience.
- HOW:** List the shots you plan to make—Actions, such as loading the gun, rolling the fire hose, and so on. This includes long shots, medium shots, close-ups, high angle of view, low angle of view; point of focus; and any unusual lighting conditions.

Remember, the shooting script is used as a guide; that is its only purpose. It is intended to keep you on

the right track. The shooting script permits you to begin a picture-story assignment with confidence. The time spent in preparing a shooting script is compensated for by the time and confusion you save at the scene when the pictures are made.

5. **SHOOTING PHOTOGRAPHS.** The actual shooting of photographs for a picture story does not present a problem for a competent photographer. Since you have a shooting script, the decisions you must make at the job location involve only exposure calculations and camera operations. There is one problem worth mentioning; it is not always possible to capture the abstract qualities in a picture. Visual interpretation of an abstract idea is difficult, if not impossible, to achieve at times. Emotions and moods are recorded on film only through skill, perseverance, and cooperation between the subject and the photographer. Sometimes the emotion or mood may linger for only a fraction of a second. You must be prepared to trip the shutter at the precise moment the action takes place.

A picture story must have a beginning, a middle (body), and an ending. A picture story begins with a **LEAD PHOTOGRAPH**. The lead photograph is the most important picture in the story. This photograph should identify the subject matter, relate the subject matter to the slant or desired approach of the story, and create an impact. The attention-getting lead photograph should create the desire to know more about the subject.

The picture story should proceed in logical order without undue repetition or too great a step in photograph progression. Each successive photograph should contribute something significant to the development of the story and provide smooth continuity. The photographs that comprise the **BODY** of the story should have long shots, medium shots, close-ups, and be made from various points of view.

The second most important photograph is the **LAST** or **ENDING** photograph. This photograph should present the feeling of finality. It can also help the viewer to arrive at a conclusion. Although it has the ability to sway the reader's mind, a picture story should be presented objectively.

The number of photographs in a picture story is a matter of judgment on your part. Too few photographs are as distracting as too many photographs. The factor that should govern the

number of photographs is the scope of the story. For example, the story of a Navy base will require more photographs than a story about one person attached to that base.

#### 6. WRITING THE TEXT AND CUTLINES.

After the film has been exposed, processed, and contact prints made, the next step is to begin writing the text and cutlines. Review your notes carefully. Look for quotes or other information that can be used as a lead. Check all statements and facts. Remember to double-check the spelling of names. Your first attempt at writing a story should be considered a rough draft only. This is the time to correct mistakes and to verify that you have complete and accurate information. Above all, remember that the text must support the photographs. When the text is written, writing the cutlines is a rather simple matter. Do not repeat what you have already stated in the text. Cutlines in a picture story should not be confused with captions for a single picture. Cutlines for a picture story are very brief. Sometimes they consist of no more than one word. The purpose of an outline is to bridge the gap between the text and the pictures (fig. 1-5).

#### PICTURE ESSAY

A picture essay, unlike a picture story, does not have to follow a logical order, have continuity, or be objective. A picture essay allows a photojournalist to present a subject from a personal point of view. For example, how does the flight deck of an aircraft carrier affect you emotionally? Does the vast size of it overwhelm you? If so, you may photograph it abstractly with a fisheye or extremely wide-angle lens to emphasize this feeling. Similarly, you may be aroused by the hard and dangerous work on a flight deck, and your approach to the story may be from this direction.

A picture essay differs from a picture story. In the picture essay, it is the photographer's viewpoint on a given subject that is important. A picture essay is interpretive, not factual. It is an organization of pictures around a central theme; it does not have a plot, and it does not have a well-defined beginning, middle, or ending. It is not objective; the requirement for a photographer to remain unbiased and factual is eliminated from the coverage. It is actually through the photographer's point of view that the reader sees the subject.

To create a picture essay, you must organize several pictures on a single theme to give a deeper, fuller, more rounded, more intense view of the subject than a single picture could. It does not matter what method you use to bind the photographs to the theme. This is the point where your creative talents can be used to explore people, events, and nature.

As with any photo assignment, research is necessary. It is through research that you will decide just how subjective you can be. Will a broad interpretation say the same thing as a tightly knit, artistic portrayal? What should be the main technique? Is more than one subjective approach required? Here again, you must research your subject, and then plan your shooting and portrayal of the subject.

Because a picture essay is subjective, you may choose to use subjective photographs to make your point. Subjective photographs, as a rule, show the subjects in a form that makes them more interesting and stimulating than usual. This is because they present the subject in a new light. Refer to figure 1-6, located at the end of this chapter, for an example of a picture essay.

You can use various pictorial interpretation techniques to produce different interpretations of an event. A few that you may want to consider are as follows:

1. **MULTIPLE IMAGES.** There are occasions when a single image is not adequate for showing an imaginative theme, mixed mental impressions of the busy world of today, or combinations of a certain background with the framing of the foreground. The technique of sandwiching two or more negatives together, double printing, double exposures, and montages is used to this creative end.

2. **INFRARED.** Black-and-white infrared film can transform the landscape from a dull photograph to an image of beauty. The amount of infrared radiation absorbed or reflected by the subject renders the subject in unnatural tones (foliage and grass appear lighter than normal because they strongly reflect infrared radiation).

3. **MOTION.** In still pictures, motion suggests action. Motion can be suggested by using a slow-shutter speed or by panning with the subject. The



Alert for any sign of trouble, a Navy hospital corpsman (left), towboat crew members and a scuba driver, watch as an Air Force water survival trainee is hoisted from Pensacola Bay by an Army helicopter from Fort Rucker, Ala.

## United States Air Force *Seventeenth Training Squadron*

The Pensacola Naval Air Station has long been home to various training squadrons. So when it was announced earlier this year that a new training squadron would be taking up permanent residence aboard the station in mid-June, it didn't seem the least bit unusual.

The squadron—which literally arrived in the Cradle of Naval Aviation in the middle of the night—however, didn't exactly fit in with the Navy's terminology of "training squadron."

Squadron members' uniforms were the wrong color blue and they piloted boats rather than airplanes. A specialized naval training unit perhaps?

Nope!

The air station's newest training squadron, although a waterborne operation, actually isn't a naval unit at all. It's the 17th Training Squadron, a component of the U.S. Air Force's 336th Training Group based at Fairchild AFB, Washington.

Previously located at Homestead AFB, near Miami, the 17th was forced to relocate to Tyndall AFB at Panama City, Fla., after Hurricane Andrew destroyed the squadron's training facilities at Homestead in August 1992. Approximately a year later, the squadron, which is responsible for Air Force water survival training, shifted its base of operations to NAS Pensacola where it will eventually be consolidated with Navy water survival training.

According to Lt. Col. Edward N. McKinney, the 17th's commanding officer, the squadron is scheduled to be disbanded in 1996 and consolidated with the Navy as an Air Force training detachment. At that time the squadron's current

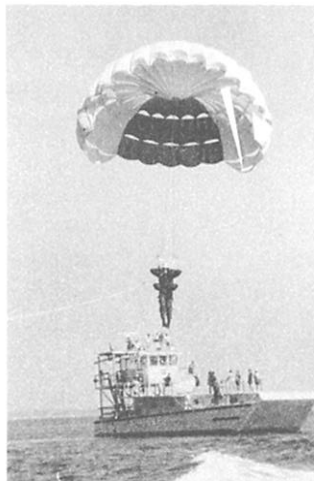

Up, up and away...an Air Force trainee makes his first parasail launch, utilizing the skills he learned in class (lower left) and wet basin (lower right).

staff of approximately 70 personnel will be reduced to around 26.

The colonel said that the 17th Training Squadron's nine 41-foot tow/pickup boats and two specially designed parasail launch craft will be turned over to the Navy in October 1995. "The Navy will be responsible for maintaining and operating the boats," said McKinney "but we'll continue to be responsible for the water survival training of Air Force personnel."

Lt. Col. McKinney said that since their arrival in the Cradle of Naval Aviation, the camaraderie between the two services, and the community has been outstanding. However, according to some of the instructor staff, there is a slight difference in terminology. But, McKinney is quick to respond, the "Navy/Air Force" acronym barrier is slowly falling away.

"We fully accept the fact that we're on a Navy base," said the colonel. "We're here to be team players and that includes fully integrating ourselves into the civilian community. We've already committed to providing boat support for next week's Fort-to-Fort Swim."

To further show his "Navy colors" McKinney said the 17th Training Squadron, which is accustomed to rooting for the Thunderbirds, is looking forward to participating in the Blue Angels' homecoming air show Nov. 11-12.

While there will no doubt always be a friendly rivalry between the two services, the highly trained professionals of the Navy and Air Force water survival training programs will greatly enhance the water survival chances for all Navy and Air Force aviators.



Figure 1-5.—Picture stories

Photo Feature  
by  
Art Giberson

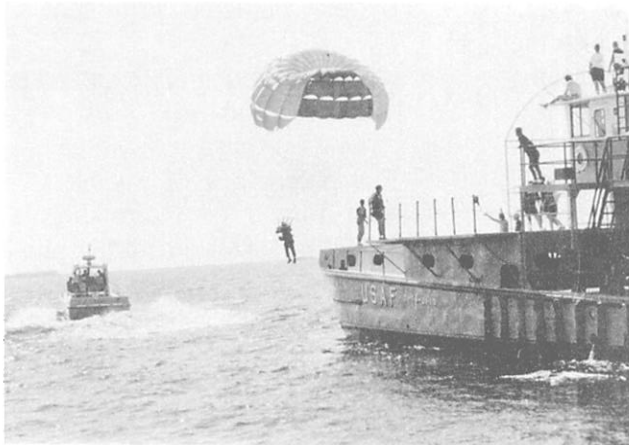

A trainee becomes airborne (left) while retired Master Sgt., now civilian employee, Dave McKay (below) moves his boat into position alongside the launch craft to take the next parasail student in tow. Students are kept under constant observation by the towboats, launch vehicle and helicopter during parasail operations.

Master Sgt. McKay and his crew (left), stay close to a trainee during the Drop and Drag portion of their training. Should a trainee have problems disconnecting from the drag harness, swimmers, such as the one straddling the rail of the towboat, will go in the water to assist.

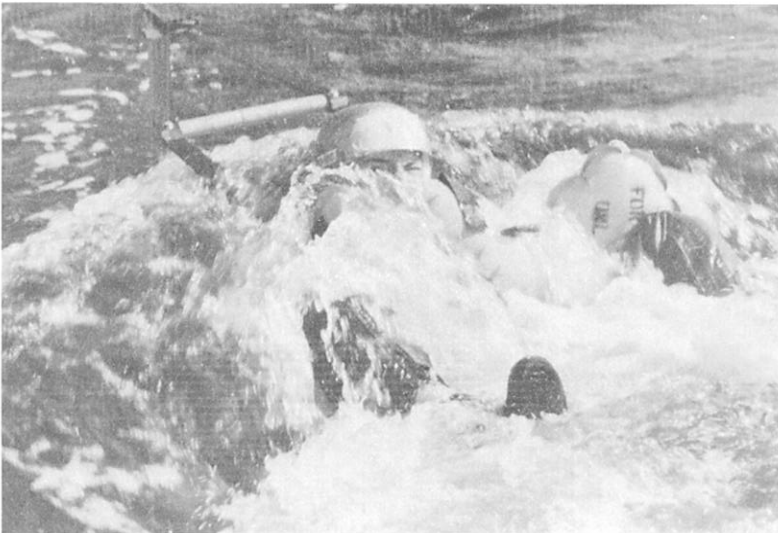

Simulating being dragged backward after ditching into the ocean (left), a student is pulled through Pensacola Bay behind the 17th Training Squadron's launch craft. Being pulled backward through rough seas, according to the instructors, is a major cause of downed airmen drowning.

Figure 1-5.—Picture stories—Continued.

end result is a sharp subject with a fuzzy background and foreground or a fuzzy subject with a sharp background and foreground.

4. **HIGH CONTRAST.** An excellent way of changing an otherwise dull picture into a piece of art. High contrast is used for symbolization. The result is a stark black-and-white print with little or no detail. Middle-gray tones are eliminated. Naturally, a strong graphic image with leading patterns and strong highlights works best.

5. **GRAIN.** Although considered objectionable, grain is very effective for certain subjects. A grainy rendition is highly effective when it is used to emphasize war, violence, prison, and so forth. Grain helps to express the mood of such subjects. It is achieved through the use of texture screens, reticulation, or extreme enlargements.

### **FLEET HOMETOWN NEWS PICTURES**

Fleet Hometown News (FHTN) pictures are brief feature stories about Navy people. These stories are released to the media in the hometown of the military member concerned.

FHTNC topics are grouped into three major categories as follows:

- Military achievements
  - a. Graduation from military schools or completion of military-training courses
  - b. Awards
  - c. Advancements or promotions
  - d. Reenlistments
- Personal achievements
  - a. Completion of off-duty education, such as college courses
  - b. Hobbies
  - c. Sporting events
  - d. Awards from civilian organizations

- Participation stories
  - a. Reporting or serving aboard a ship or station
  - b. Participating in crisis actions
  - c. Participating in humanitarian programs
  - d. Visiting foreign ports throughout the world

The photograph of a subject for FHTN can be either a formal or informal portrait. The most important aspect of an FHTN photograph is for the face of the subject to be clearly identified. When more than one person is in a photograph, the emphasis should be placed on the subject of the story.

Here are a few tips that should help your FHTN features get released:

- Do not submit photographs that could be embarrassing to the subject or to the Navy.
- Fill the photograph with the largest practical image size and “tighten up” two or more subjects to avoid unwanted space between them.
- Ensure the subject is properly attired for the task at hand.
- Ensure the background is suitable for the photograph.
- Avoid photographs where the subject appears to be posing (except for a formal portrait).
- Use lighting that does not conceal large portions of the subject’s face.
- Since text in a newspaper and other periodicals is in columns, vertically composed photographs are preferred by editors.
- For the most up-to-date information on procedures and specifications for hometown news stories, refer to *Instructions and Policy Concerning Fleet Home Town News Program*, SECNAVINST 5724.3.

## NEWS WRITING

No matter what news value or interest a story may have, it must conform to a particular format or style. In literary writing, style is generally determined by the author. It is obvious, however, that a literary writer is not concerned with news style or the fundamentals of news writing. Take the following quotation for example:

*"It is a thing well known to both American and English whale ships, and as well a thing placed upon authorative record years ago by Scoresby, that some whales have been captured far north in the Pacific, in whose bodies have been found the barbs of harpoons darted in the Greenland Seas. Nor is it too be gainsaid that in some of these instances two assaults could not have exceeded very many days. Hence, by inference, it has been believed by some whalemens, that the North West Passage, so long a problem to men, was not a problem to the whale."* Perhaps this quotation is familiar to you. It is from Moby Dick. Its author, Herman Melville, was known for his moving literary style. If a modern-day journalist were writing this same piece for a newspaper, it would probably read like this:

*"The North West passage, long sought by man, may be known and used by whales.*

*American and British Sailors have reported finding the barbs of harpoons from Greenland in the bodies of whales killed in the North Pacific. In some cases the wounds were only a few days old. This has led some whalers to believe that whales must use some shortcut from the North Atlantic to the North Pacific."*

As you can see from the above example, in news writing all the frills are stripped away. The story is written so it can be understood by all readers. The purpose of the news story is to inform—not to impress.

Short stories or novels and other forms of literature are usually written in chronological order. This means the author starts at the beginning, sets the time and place, describes the scene, introduces the characters, then slowly weaves and threads the plot until a climax is reached. The climax is deliberately held back to build suspense and to dramatize the events that hold the reader's interest to the end. In fast-moving society, few people have the time or desire to read every word of every story. Therefore,

in modern news writing, the story is constructed so the climax is presented first. With this method of writing, the most important facts are placed in the first paragraph of the story. It then moves into the detailed portion of the story by covering the facts in diminishing order of importance. Before attempting to put words on paper, a good writer must be particularly conscious of the elements of journalism: accuracy, application, brevity, clarity, coherence, emphasis, objectivity, and unity. These are the characteristics of a story that provide the credibility that is so highly valued by professional newspeople.

## WRITTEN LANGUAGE

The written language consists of three basic elements: words, sentences, and paragraphs.

### Words

Words are your basic writing tools. Like any skilled technician, you must be able to select the best tools for the job. This means you should use words that say exactly what you mean; otherwise, people may take statements out of context. Use common words that are easy to understand. Multisyllable words add confusion. Strong, active verbs inject life, action, and movement into stories. Strong verbs help to eliminate the need for adverbs. In news and feature stories, adverbs often clutter the writing.

### Sentences

The simple declarative sentence consists of a subject and verb, or subject, verb, and object. It is the most common sentence in informal conversation and thus should be used for writing news items. Ideally, sentences should consist of 30 words or less and average about 15 to 18 words. Sentences should vary in length; for example, use an 8-word sentence, then a 12-word sentence, followed by a 25-word sentence, and back to a short sentence. Do not crowd too many details into one sentence. Although a compound or complex sentence may contain more than one thought, you should attempt to construct simple sentences that express a single thought clearly and concisely.

### Paragraphs

Paragraphs should be reasonably short. People can grasp a small amount of information more easily than complex amounts of information. When possible, a paragraph in a news or feature story should be 60

words or less. Two or three sentences per paragraph are about right, but it is perfectly acceptable to have one-sentence paragraphs or even a one-word paragraph that expresses a complete thought.

## WRITTEN ARTICLES

The components of a written article are as follows: lead, bridge, body, and ending. Articles or stories written by Navy photojournalists are called "straight news" (sometimes referred to as hard news) and features. The difference between the two types of news is the degree of immediacy and the manner in which each one is constructed.

A NEWS STORY is written so the most important facts of an event or story are placed first and the less important facts are placed in the order of diminishing importance.

A FEATURE STORY, however, can have the important facts inserted anywhere in the text, depending on the desires of the writer.

### Story Lead

The opening passage of an article is the lead. In a news story, this passage contains the most important facts. The lead may be a word, sentence, paragraph, or two paragraphs. The manner in which the lead is written, regardless of whether the article is news or features, is often the determining factor as to whether an individual will continue reading. Story leads are written in two general styles: the summary lead and the novelty lead.

1. SUMMARY LEADS. Summary leads are used mostly for news articles. This type of lead summarizes the important facts of a story and answers the questions related to the five Ws and H. The writer determines which of the facts is most important to start the lead. An example of a summary lead is as follows:

"A Ship's Serviceman headed off a major fire aboard the USS *Rickety* yesterday by using a washing machine as a fire pump."

The questions answered are as follows:

WHO: A Ship's Serviceman

WHAT: Headed off a major fire

WHERE: Aboard the USS *Rickety*

WHEN: Yesterday

WHY: To prevent the fire from spreading

HOW: By using a washing machine as a fire pump

2. NOVELTY LEADS. Novelty leads differ from summary leads in that they do not answer all of the questions related to the important facts. Novelty leads are used mostly for feature articles. They can be further classified as picture, background, contrast, question, shock, quotation, direct address, and freak.

a. Picture. This lead draws a vivid word picture of the person or event in the story. For example, "The drain hose of a washer running on the spin-dry cycle became a fire hose in the hands of a quick-thinking Ship's Serviceman."

b. Background. This type of lead is similar to the picture lead, except it draws a vivid word picture of the news setting, surroundings, or circumstances. For example, "Deep inside a U.S. Navy ship, a solitary Ship's Serviceman battled a pile of burning clothes with the only means at hand—his washing machine."

c. Contrast. The contrast lead compares two opposite extremes to dramatize a story. For example, "Two years ago, the crew of the USS *Turnip* went without clean clothes for 3 weeks as the result of a laundry fire. Yesterday, aboard the USS *Rickety*, a resourceful Ship's Serviceman saved two hundred shipmates from a similar fate."

d. Question. The question lead should arouse the curiosity of the readers and make them want to read on. For example, "When the fire extinguisher does not work, how do you put out a blaze in the laundry compartment?"

e. Shock. This consists of a blunt, explosive statement designed to surprise the reader. For example, "The fuse to a potential holocaust was ablaze."

f. Quotation. This type of lead is a short quote or remark. A quote lead should only be used when it is so important or so remarkable that it



overshadows the other facts in a story. An example, "Thank goodness the washer was full of water," said the Ship's Serviceman who used the drain hose to put out a laundry fire.

g. Direct Address. This lead is aimed directly at the reader and makes the reader a collaborator with facts in the story. The lead usually contains the pronouns you or your. For example, "Because a Ship's Serviceman used the wash water to put out a fire, you will have your whites back in time for liberty on Friday."

h. Freak. The freak lead is the most unconventional of the novel leads. It contains a play on words, alliteration, poetry, or an unusual typographical arrangement. For example, "Smoke-eating Ship's Serviceman douses blaze in duds."

### **Story Bridge**

In some stories, the transition from the lead to the body can be awkward. To help smooth this transition, you should use a sentence or paragraph to "tie" the lead to the body. This sentence or paragraph can contain detailed information that is not important enough for the lead but is too important to be placed lower in the text. An example of a bridge is as follows:

Lead: "Smoke-eating Ship's Serviceman dampens disaster with washer drain."

Bridge: "Yesterday, a smoke-eating Ship's Serviceman who was running the laundry used the washing machine drain to put out a fire."

### **Story Body**

The body is the detailed portion of an article that explains the facts of a story.

### **Story Ending**

A good ending or conclusion terminates an article in a positive manner. It should leave the reader satisfied that the story was worth reading. Story endings are used more in feature articles than news articles. An example of a story ending is as follows:

"Thus, by quick action, the Ship's Serviceman saved the clothing of the crew and stopped a fire that threatened the ship."

## **PICTURE LAYOUT**

The picture layout is an arrangement of photographs, text, white space, illustrations, and other elements that make up the pages of a newspaper, magazine, or display. The message that you extend to your readers should be easy to read and understand. This layout of elements should be such that the reader can follow them in a logical progression. A good layout is INVISIBLE to the reader. When the layout is visible, it is distracting to the reader and the message may be lost.

The success or failure of a layout depends on its emotional and visual impact. DIRECTIONAL LINES OF FORCE are the primary elements that cause the reader to flow with or against the story. Directional lines of force are used to build reader interest.

When you are laying out a page that is dominated by photographs, such as a picture story or picture essay, the selection of pictures should be determined by the importance and complexity of the story.

### **PRIMARY OPTICAL AREA**

Since we read text from the left and downward, we have a tendency to first focus our eyes on the upper-left corner of a page or display board. This area is the PRIMARY OPTICAL AREA and should contain an element that attracts your eyes at first glance.

### **DIAGONAL**

Our eyes scan in smooth-flowing, back-and-forth loops. Attracted by appealing elements, our eyes move downward diagonally from the primary optical area toward the bottom-right area of the page. Typically, this bottom-right area is the ultimate goal of our eye scan movement. Once our eyes have reached this area, our mind knows automatically (from habit) that the page has ended. You must use elements that appeal to the reader to attract attention away from the diagonal to the corners of your layout. Since the natural tendency of the eye scan is in a downward direction, you should not use elements that cause the scan to backtrack and read higher on the page; for example, a strong leading line that redirects the attention of the reader upward and into an area of the story that has already been read.

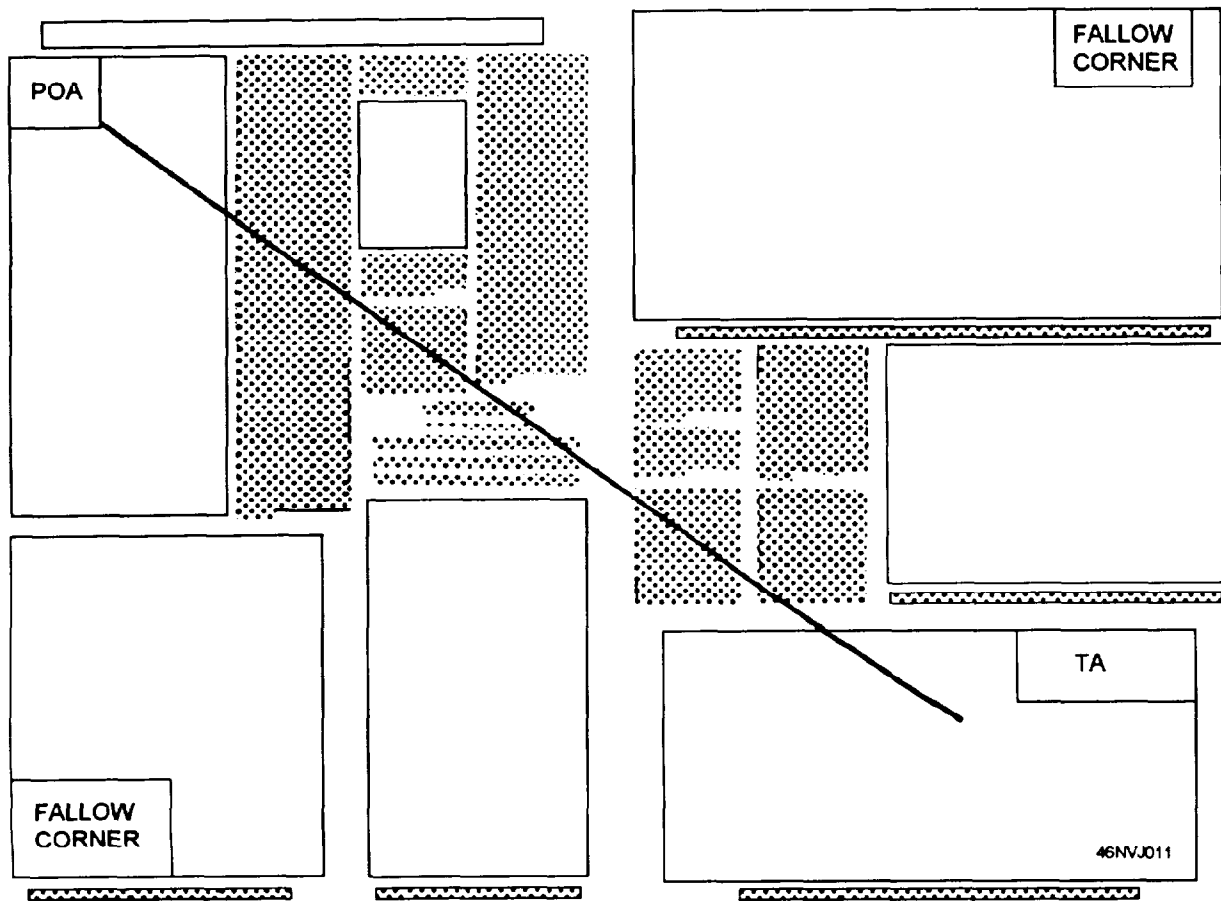

Figure 1-7.—Picture Layout.

With leading lines and other elements in a layout, you can suggest to the reader's subconscious mind that the eyes follow a desired course through the page. For example, a photograph placed in the primary optical area should have leading lines that direct the eyes of the reader into a page or story. These lines must not direct the reader's attention away from or out of the story.

### DIRECTIONAL LINES OF FORCE

The two weakest points on the page are known as **fallow corners** (upper right and lower left). An element placed in the fallow corners must be strong enough to attract and hold the eye of the reader.

Directional lines of force, whether real or implied, are what causes the eye to move from the primary optical area through both fallow corners and finally end up at the terminal area.

When laying out pictures, you must locate the directional lines of force and use them to build reader interest. Then you must force the eye of the reader to flow with the story. Lines of force may be established by picture direction, or they may be formed by other elements, such as a headline, a copy, or the shape and size of a photograph. The most important thing to remember is that the directional lines of force should direct the reader from one area to another. (See figure 1-7.)

### COMPOSITION

Composition in layout may have several patterns. For example, the elements of layout can be arranged in the form of pyramids, inverted pyramids, Ss, or reversed Ss.

When the layout consists of two or more pages, you should establish unity between pages. This can

be affected by continuity of photographs from page to page or by extending a photograph or title across the gutter (margins between pages).

Photographs for a picture story or picture essay should be edited until only the photographs required to tell the story remain. You must decide what number of photographs to use for the story as well as what form of composition to use. Often, the content of the photographs will assist you in making decisions about the compositional form.

As discussed previously, the lead photograph in a picture story or essay should be "eye catching" and create impact. The lead photograph does not have to be placed in the primary optical area; however, it should be placed in the layout so it sets the theme for the story. Similarly, the end or closing photograph should produce a feeling that the story has ended.

After the photographs are selected for story-telling content, you should construct thumbnail sketches to assist in determining the best layout for that particular story. A thumbnail sketch is a rough sketch idea of the layout. You may have to construct several thumbnail sketches before deciding on the best layout (fig. 1-8).

You should crop the photographs on an easel during printing, and print them to correct size for the

layout. By knowing layout size and using a thumbnail sketch to determine relative size, you can determine the exact size to print the photographs.

When cropping is required after the photograph is printed, you should place a sheet of thin paper over the photograph. Mark the thin paper, rather than the photograph, with crop marks. Crop marks are lines or dashes, in pencil, that indicate where to crop the photograph.

## SCALING

Scaling is the procedure whereby you calculate the size that a photograph is to be reduced or enlarged.

The simplest method for scaling your pictures is to use a common diagonal. Place a sheet of tracing paper over the picture being scaled and draw a diagonal line on the paper over the picture or where the crop marks are indicated. Determine the size of the finished picture along the bottom. Now raise a perpendicular line until it meets the diagonal line; this is the height of the finished picture.

When you use the diagonal method of scaling, everything that is in the original print, or indicated within the crop marks, will be in the scaled reproduction.

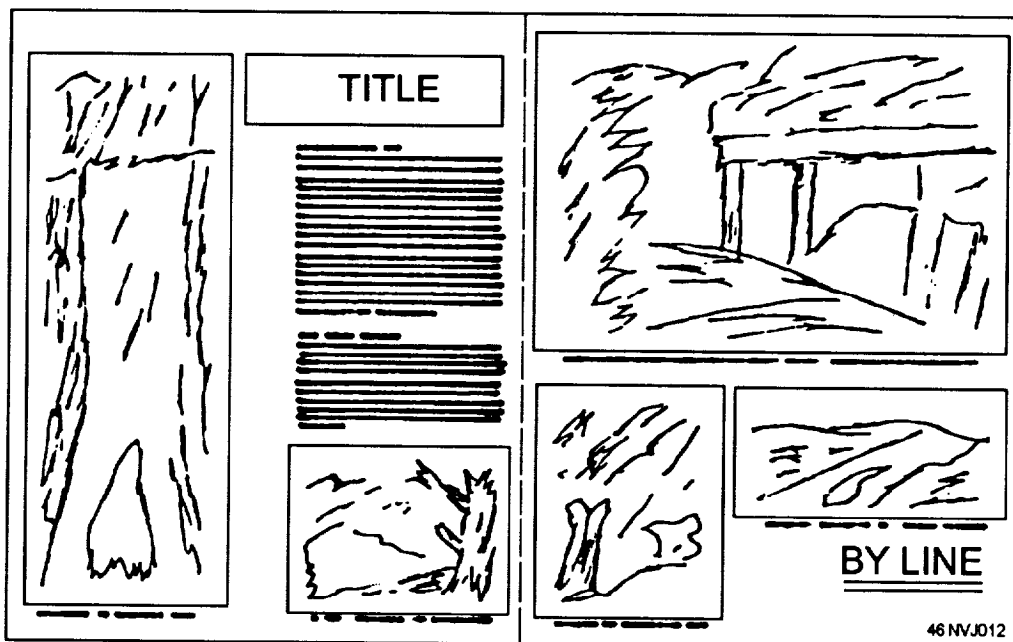

Figure 1-8.—Thumbnail sketch for a double-page layout.

When laying out a page or display, you should consider carefully where to establish the margins. The margins should be equal at the top, bottom, and on the outside with a narrower margin at the gutter. A copy should never extend outside the margin, although photographs may do so when they bleed off. Bleeding off is when the photograph extends to the edge of the page. The space between photos, text, and headlines should be one half of the space of the gutter.

The layout is a showcase for displaying your photographic skill. The entire layout must be functional, and it should be invisible. It should not call attention to itself, but rather to the underlying story. The best way to achieve an invisible layout is to avoid gimmicks. Fancy background, photographs cut at odd angles, and collages are totally unacceptable in a professional layout.

## UNITY

When the story requires more than one page or display board, you must position and align the page elements (copy, pictures, headlines, and cutlines) to establish unity. Each page should have one dominant element. This can be a large photograph, big headline, or copy set in a special way. Unity must continue from page to page. You can do this by story continuity or by a headline or photograph that runs across the gutter.

Remember, no matter how the various elements and pages are unified, they must present a total package that is easy and convenient to read. This is the whole purpose of layout.

Figure 1-9 shows an example of how unity is maintained. Notice that if you use large photographs

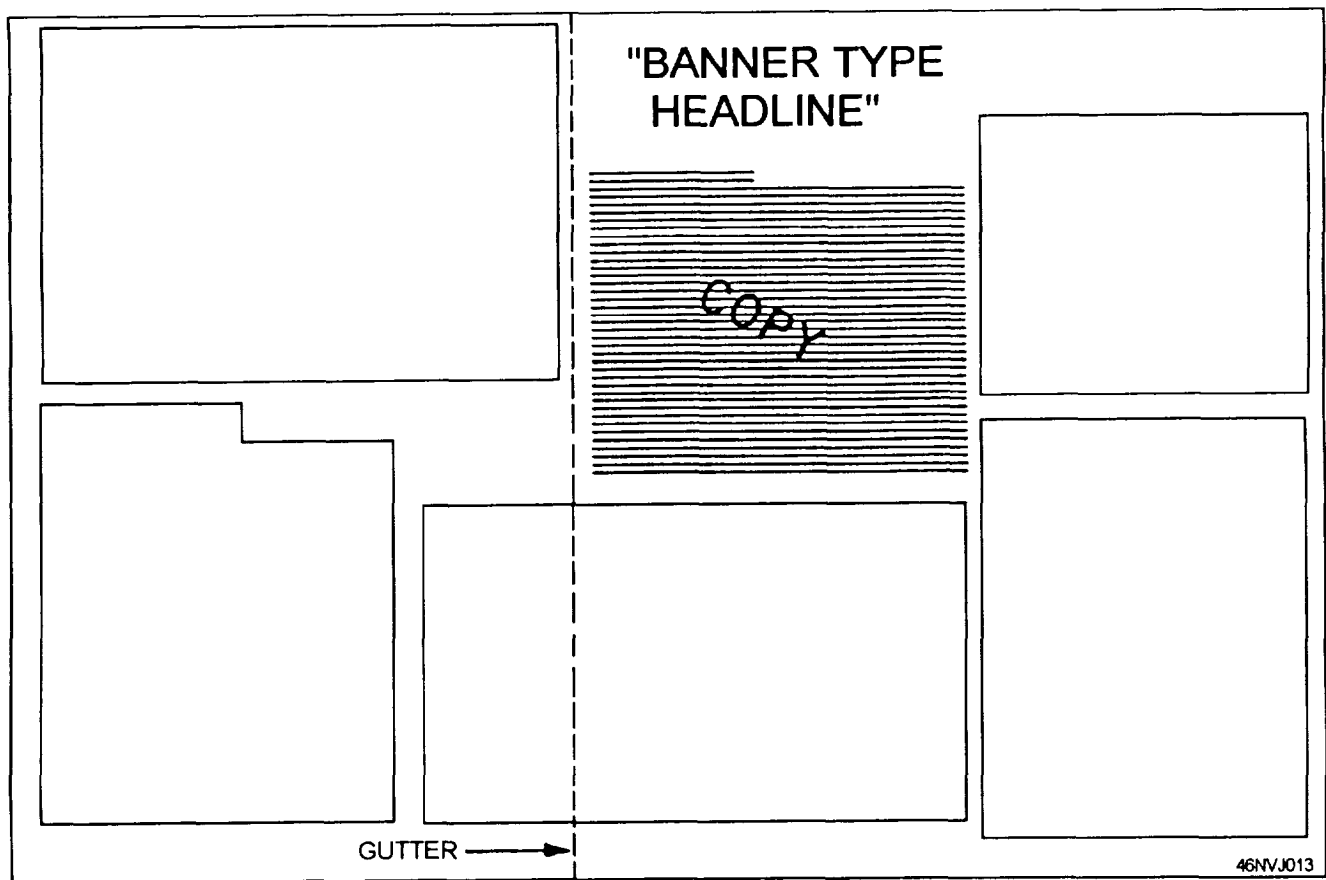

Figure 1-9.—Maintaining unity.

on page 1 and extend them on to page 2 that the photographs run across the gutter. Thus unity is maintained by using a "Banner" type of headline, a large copy block, and photographs.

## **CONTRAST**

Contrast is achieved in a layout by using different picture sizes and shapes. This helps add interest and drama to the layout. It also aids the reader's flow through each element to improve communication.

### **Lead, Body, and End Pictures**

When you are laying out a page that is dominated by photographs, such as a picture story or picture essay, the selection and number of pictures should be determined by the importance and complexity of the story. Of course, the amount of space you have to lay out the story is a factor. However, no matter how important or complex the story may be, your basic picture requirements remain the same. Every story must have a beginning, a middle, and an ending. Additionally, every layout should have one large dominant photograph to grasp the attention of the viewer. Other photographs used in your layout should not exceed 50 percent of the size of the dominant photograph. The two most important pictures again are the lead and the end photographs. Besides having the necessary stopping power to attract the attention of the reader and creating the desire to know more about the subject, the lead picture should give the reader a hint as to what the story is about. In other words, the lead photograph performs the same function as the opening paragraph in a written news story. The end photograph should help the reader to see the significance of the story, summarize it, and bring it to a logical conclusion. The remaining photographs in a story should consist of a variety of sizes, shapes, long shots, medium shots, and close-ups. Their task is to maintain the interest that is built up by the lead and carry it throughout the story until the end shot is reached. The body photographs, like the middle of any story, are the "meat" of the whole statement that you are trying to make and should not disappoint the reader.

### **Layout Space and Editing**

The space allowed for a story, for the most part, is predetermined. Military newspapers, as well as civilian publications, retain their page size issue after issue. The board on which you mount your display

prints may also limit the size of your layout. Therefore, your story must fit the space allowed and not vice versa.

It has already been stated that the lead and end photographs are the two most important. This does not mean, however, that when you go out on an assignment you should have a predetermined lead and an end shot in mind. On the contrary, the lead and end photographs are selected from the overall coverage. Once the story is shot, you screen the proofs and select the photographs. Always choose the lead picture first. Next, choose the end picture. After selecting the lead and end pictures, choose the body pictures. After all the photographs have been selected, edit them so only those that are absolutely necessary for telling the story remain.

The editing process must be cold and objective. Forget the fact that you may have hung by one toe from a 100-foot flag pole to obtain a certain shot. If the shot does not fit or is not essential, then it has no place in the story. During the editing process, you should select only those pictures that are valuable communication symbols when arranged in a logical and story-telling manner.

After you have selected the lead, end, and body pictures, you should then make a thumbnail sketch to determine picture placement and size.

There is a certain amount of aesthetics involved in a layout. After gaining experience by doing a few layouts, you tend to "feel" your way. Nevertheless, there must be a starting point. For the most part, it is strictly mechanical.

All elements, titles, subtitles, pictures, copy, and white space should be aligned with one or more of the other elements on the page or pages. This system of aligning elements, or the "buddy" system as it is called, is another way of saying that margins must be established and maintained throughout the layout. From the very beginning, you must establish a definite set of margins to provide consistency from element to element and from page to page.

Layout is second in importance only to the story content; like the frame on a picture, it can make or break your work. For it to be effective, it requires skill, imagination, and painstaking care.

Today, most layouts are constructed using computers. There is a vast variety of software packages available on the market that are used

specifically for this purpose. The use of computers in electronic imaging and layout is discussed in chapter 3 of this training manual.

**This page is intentionally left blank.**

(Right) 8:10 a.m. AN Josh Nichols jumps from the mock helicopter door at Training Tank 2 as part of final testing in Rescue Swimmer School.



(Right) 7:40 a.m. Members of the NASPAO staff during quarters. Gosport staff members had already prepared their camera gear for the daylong photo shoot.



# Any day in the Navy

(Right) 10:01 p.m. Lt. Charles Pratt, BLAB TV cameraman Stan Rabin, Corry Station MWR Director Pete Bender and host J.B. McKamey wrapping up "NAS Live."

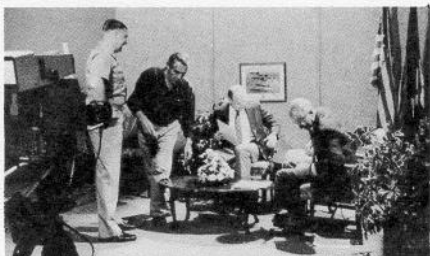

Two weeks ago, May 18, the crack Gosport staff fanned out over many parts of the Pensacola Naval Complex and aboard the USS Jesse L. Brown (FF-1089) to capture on film *Any Day in the Life of the Navy* as part of the *All Hands*-sponsored photo shoot. The photo session was a long one, running from midnight to midnight in a one-day period. The station weekly's staff—armed with cameras, various lenses, loads of film, notepads and taperecorders—captured images from well before sunup to well after sundown showing life in the complex in a 24-hour period. We will be submitting all of the pictures shown here (some in color) and more to *All Hands* for the contest, pictures selected to be displayed in the October issue of the *Navywide* magazine.



(Upper middle right) 9:40 a.m. An emergency rescue technician treats a "victim" during a disaster drill at NTTC Corry Station.

(Above) 9:15 a.m. AT2 Rodney Boyles is reenlisted by Lt. Mike Baker by the Blue Angels' Fat Albert.

(Right) 7:30 a.m. OCS candidate Michael A. Karr performs "motivational" pushups in between practicing drill and ceremonies.



Figure 1-6.-Picture essay.



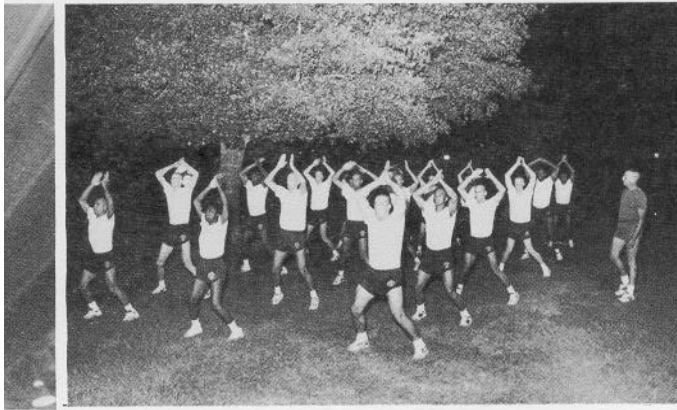

(Above) 5:05 a.m. Members of OCS Class 05-94 perform physical training.

(Below) 6:27 p.m. HM3 Kirk Shanley of the NAS Search and Rescue unit scans the beaches on a training flight in an UH-3 helicopter.

(Below middle right) 2:22 p.m. SM(SW) Sammie Young, onboard the USS Jesse Brown, sends Morse messages to the USS Moinester.



(Below) 4:15 p.m. Gosport staffer Scott Hallford debarks the USS Jesse Brown after a daylong cruise documenting shipboard activity.



(Right) 1:35 p.m. OCS candidates march under the watchful gaze of drill instructor Gunnery Sgt. George Shine.



10:40 a.m. Lt. Cmdr. Sherry Galloway examines HM3 Michelle Satchall during the disaster drill at the naval hospital.

Figure 1-6.—Picture essay—Continued.



## CHAPTER 2

# PHOTOGRAPHIC QUALITY ASSURANCE

To be successful in using photographic materials in Navy imaging facilities, you must establish a high standard of quality. This quality standard should be aimed at producing negatives, transparencies, and prints to please the most demanding and critical customer. This standard must be flexible enough to allow for improvement, whenever possible. However, it must resist a compromise of poor quality. Once that high-quality standard is established, you can maintain it through an exacting and practical method of quality assurance.

Quality assurance (QA) in photography has one purpose—to ensure that photographic production is consistently of high quality, whether it be a negative, print, transparency, or other form. The quality of these products is determined by three factors, each having a number of variables. These factors are human, chemical, and mechanical. The human factors include the personnel involved in photography, photographic development and/or printing, as well as those photographers who work directly in the quality assurance section of an imaging facility. Chemical factors include all chemicals and solutions used to process and print negatives, positives (viewing and intermediate), duplicate negatives, and prints. Mechanical factors include all equipment used to develop and/or print film and subsequent reproductions.

Quality assurance can be either subjective or objective. A subjective quality assurance program may simply be a set of standard high-quality negatives, prints, or transparencies with which production results are compared visually. Although this is not a very reliable system, it works well aboard a small ship or at a small shore facility where a low volume of production is performed daily. A subjective quality assurance program certainly is better than no program, but it cannot take the place of an objective program. The visual-comparison method is very subjective and has limited accuracy.

Quality assurance may be applied to either a portion of the photographic system or the entire system. In quality assurance there are three basic steps:

- The quality standards for the process are specified
- The process is evaluated to ensure the standards of quality are being maintained.
- The causes of poor or substandard quality are identified and eliminated from the photographic procedures.

Detailed quality assurance applied to the photographic process assures the photographer a better product when potential problems are detected early. If a defective camera is allowing light to fog film, the defect should be discovered after the negative is processed (if not sooner). Certainly, it is a waste of time and material to make prints from such negatives if the photograph must be reshot. In this chapter, several quality assurance procedures that can improve the product are discussed.

Chemical and sensitometric methods are used to ensure standards of quality are being sustained. The production of high-quality photographic products requires control over all factors that affect film or paper. Film exposure and processing are the two most important factors. Negatives or transparencies that are not exposed correctly and processed uniformly may have density differences (contrast) that are not within acceptable limits. Such negatives or transparencies cannot be printed successfully. Correct exposure and film processing have a direct and positive bearing on both prints and projected image quality. Good-quality negatives and transparencies also help cut operating costs by reducing waste due to retakes or reprints.

Manufacturers of films, chemicals, and papers recommend specific film exposure, chemical mixing, replenishment, processing times, temperatures, agitation techniques, wash rates, and printing and drying requirements. To be sure that such recommendations are followed in your imaging facility, you should systematically monitor the photographic process.

Any monitoring system for the photographic process requires that a *reference* or *standard* be established. By systematically comparing daily production to the reference, you can detect, identify, and correct errors in procedure.

Any photographic quality assurance system should be built around the science of sensitometry. In its broadest terms, *sensitometry*, as applied to the whole photographic process, includes methods of measurement, process control, and data analysis. It deals with all areas of the photographic process, from exposing film to viewing the final image.

## **SENSITOMETRY**

In the *Photography (Basic)*, NAVEDTRA 12700, training manual, the quality of the photographic product was judged only from its visual aspects. As a further step, you should know of other controlled working methods and techniques that ensure

photographic quality. This area of control, or sensitometry, is one method of using certain photographic theories to improve photographs while saving time, effort, and materials.

With sensitometry, variations from the standard and recommended corrections are expressed in numbers and not in terms of personal opinion. Sensitometry provides a permanent record of the process and indicates whether the system was in control when a given film or paper was processed. The accumulated data is helpful for determining the cause of poor quality and the exact amount of deviation from the standard.

The first requirement in photographic quality assurance is establishing a standard for good processing and the range or limit that quality should not exceed. The standard is based on developing the same film or paper that is given a known exposure and comparing the resulting densities. Black-and-white processing is discussed first in the following paragraphs.

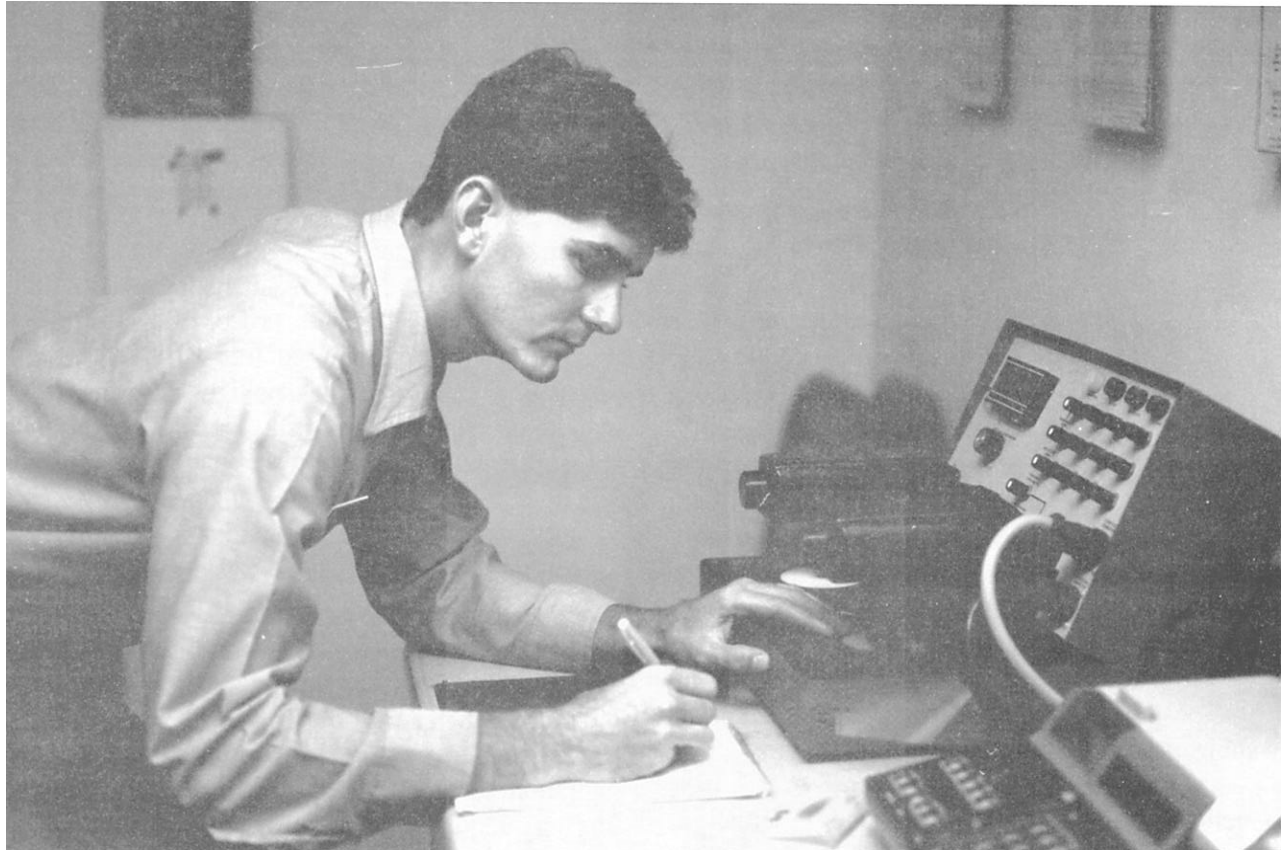

**Figure 2-1.—A Photographer's Mate uses a densitometer to read a control strip.**

Since it would be impossible to judge whether densities are reproduced accurately by viewing your normal production products, special test strips, or control strips, are prepared. The test strips are exposed accurately with varying amounts of light. These test strips are developed in your process, and the resulting densities are read on a densitometer and averaged together (fig. 2-1). The densities are then plotted on a graph. The plot of the data establishes the standard. Similar test strips are then processed at regular intervals and compared with the standard to ensure that the processing is under control. This, basically, is sensitometry.

Another term used in conjunction with sensitometry is densitometry. Densitometry is an integral part of sensitometry. These two terms are often used together or interchangeably. Technically, however, there are differences between them. The differences are as follows:

- Sensitometry, or measurement of photographic sensitivity, is the science of determining the photographic characteristics of light-sensitive materials.
- Densitometry, or measurement of densities, is the method whereby data are obtained for sensitometric calculations.

Measurements of densities are done on a logarithmic scale. To understand sensitometry, you must become acquainted with logarithms.

## COMMON LOGARITHMS

Complex problems can be calculated easily and accurately by means of logarithms. You can add logarithms to achieve multiplication, subtract them to achieve division, and divide them to derive square roots.

In photographic quality assurance, logarithms are used for the following:

- Determining density
- Plotting characteristic curves
- Determining contrast
- Determining log H
- Reading the densitometer scale

A common logarithm ( $\log_{10}$ ) is an exponent to a base number of 10. The base 10 is used because our numerical system is based on units of 10. This can be demonstrated easily by using scientific notation, or "powers of 10" For example, the logarithm of 100 is 2, because  $10^2$  equals 10 times 10, or 100. The logarithm of 1,000 is 3, because  $10^3$  equals 10 times 10 times 10, or 1,000. Table 2-1 shows how some common logarithms are computed. Notice the relationship between the exponent (superscript) and the common log.

Table 2-1.—Examples of Some Common Logarithms

NUMBER (ANTILOG)	EXPONENT	LOGARITHM
10,000	$1 \times 10^4$	4
1,000	$1 \times 10^3$	3
100	$1 \times 10^2$	2
10	$1 \times 10^1$	1
1	$1 \times 10^0$	0
0	$1 \times 10^{-1}$	-1
0.10	$1 \times 10^{-2}$	-2
0.001	$1 \times 10^{-3}$	-3
0.0001	$1 \times 10^{-4}$	-4

The original number in table 2-1 is also called an *antilog*. Notice that a number greater than one is a positive log. Any number less than 1, but greater than zero, is a negative log.

Logs are also required between the numbers 1 and 10. Since the log of 1 is 0 and the log of 10 is 1, the numbers 1 through 9 are decimals. (See table 2-2.)

Notice the relationships between numbers and their logs as follows:

- When numbers are multiplied, their logs are added. Example:  $8 = 2 \times 4$ . The sum of log 2 and log 4 equals log 8:  $0.30 + 0.60 = 0.90$ .

- When numbers are divided, their logs are subtracted. Example:  $3 = 6 \div 2$ . Log 3 is the difference between log 6 and log 2:  $0.78 - 0.30 = 0.48$ .

The previous discussion is provided to give you a general idea on how logarithms are derived. It is not necessary for you to memorize logarithms, or refer to the log tables. All scientific calculators have a "log" key that converts numbers to logarithmic form. You should become familiar with the functions of your calculator before proceeding with the study of photographic quality assurance. For more information on using logarithms, refer to the chapter on logarithms in *Mathematics*, Volume 1, NAVEDTRA 10069.

One of the main uses of logarithms in photographic quality assurance is to take the numbers used to indicate exposure in characteristic curves and reduce them to a manageable form. For example, the

sensitometer in your imaging facility is set on an exposure time of 1/100 second and provides an illuminance of 80,000 lux (or meter-candles). The log exposure can be calculated easily as follows:

$$E \times T = H$$

$$80,000 \text{ (lux)} \times 1/100 \text{ (set)} = 800 \text{ lux seconds}$$

$$\text{The log exposure} = \text{the log of 800 or 2.90}$$

When you convert exposure to logarithmic form, both density and exposure are on the same scale. A characteristic curve indicates how exposure and processing differences affect photographic emulsions by comparing density and the log of exposure.

To describe sensitometry, you must become acquainted with several new terms and formulas. As a starting point, you should become familiar with the terms *transmission*, *opacity*, and *density*, or T, O, and D.

## TRANSMISSION

Most photographic material, even clear film, does not transmit all of the incident light that is relevant to it. Transmission is a measure of the light-passing ability of a film or other medium. The transmission of a processed film refers to the fraction, or percentage, of incident light that passes through the film.

In a formula, transmission is represented by a capital letter T. The formula for determining transmission is as follows:

$$T = \frac{\text{Amount of transmitted light}}{\text{Amount of incident light}}$$

The result is never more than 1/1, or 1.00. For example, when 10 meter-candles (mc) of light are incident (or falling) to a film and 5 mc is passing through it, the transmission is as follows:  $T = 5/10$  or  $T = 0.50$ , or 50 percent. When 2 mc is transmitted, the formula reads  $T = 2/10$  or 0.20, or  $T = 20$  percent.

## OPACITY

Opacity is the ability of a medium to absorb light. The two terms, *transmission* and *opacity*, are directly opposite in meaning. Opacity is indicated in a

Table 2-2.—Common Logarithms Between 1 and 10

NUMBER	LOGARITHM
1	0.00
2	0.30
3	0.48
4	0.60
5	0.70
6	0.78
7	0.85
8	0.90
9	0.95
10	1.00

formula by the capital letter  $O$  and is the reciprocal of the transmission ( $T$ ). The formula for opacity is given as follows:

$$O = \frac{\text{Amount of incident light}}{\text{Amount of transmitted light}}$$

You can see that opacity is the transmission formula inverted. Again, when a material has 10 mc of light falling on it and 5 mc is being transmitted, you can determine the opacity by the formula  $O = 10/5$ , or 2. Putting it a different way, opacity is the reciprocal of transmission, or  $O = 1/0.50 = 2$ . Or, when 2 mc is being transmitted, the formula is  $O = 1/0.20$ , or  $O = 10/2$ ; in either case, the opacity is 5.

## DENSITY

Density is indicated by the capital letter  $D$  and is another way of expressing opacity or the light-stopping ability of a medium. Density is nothing more than the common logarithm of opacity. For example, when opacity is 2.0, the density is  $\log 2 = 0.30$ .

In sensitometry, *density* is the term with which you are most concerned. However, density cannot be disassociated from transmission and opacity, because they all are dependent and directly related to each other. When the value of any one of these factors is known, you can calculate the others. When you know the transmission of a film, you can easily determine the density. Or conversely, you can measure the density and then determine the amount of transmission. While charts are available to provide some conversions directly, you should be capable of determining any of those figures.

## SENSITOMETERS

Sensitometric-densitometric testing requires a method of providing the exact same exposure to different emulsions, or the same emulsion type that is processed differently, and then comparing the resulting densities.

Sensitometers make controlled exposures that are suitable for sensitometric-densitometric testing procedures. Densitometers measure density.

For sensitometric testing purposes, you must provide a way of exposing sensitized material with a known quantity and quality of light.

One of the first requirements for sensitometric control is to have a sample of the light-sensitive material that has been exposed properly under measurable and reproducible conditions. For sensitometric test purposes, it is common practice to expose a strip of film, so a number of varying exposures are made on the same strip. This series of controlled exposures is made with a sensitometer through a series of neutral-density filters.

Ideally, a sensitometer should be designed so you can do the following:

- Predetermine the total amount of exposure.
- Determine the difference in exposures given to various areas.
- Control the color quality of the light.
- Reproduce or duplicate the exposure consistently.
- Obtain a wide enough range of exposures to produce densities ranging from very light to dark.

Scenes that might be photographed include a wide range of brightness values that are represented on a negative as areas of varying amounts of density; however, these different densities are scattered throughout the picture area and are difficult to measure. For the sake of simplicity, uniformity, and reproducibility in the application of sensitometry, the exposures produced by a sensitometer are arranged in a series of gradually increasing steps. These steps correspond to the relative brightness values of a normal scene. The exposures are made on a length of film or paper of the same type that you are processing. This sample is called a *sensitometric strip*.

"Photographic exposure" is defined as the product of illumination and time. The two important parts of a sensitometer are the light source and the device for controlling the amount of light transmitted to the emulsion. Since total exposure is the result of the intensity of illumination and the length of time it is

allowed to act, the exposure may be varied by changing either the intensity or the time.

Light sources for a sensitometer must be carefully chosen, and their characteristics must be precisely known. The intensity of the light must also be known. The time of exposure should correspond closely with actual photographic practice and must remain constant over long periods of time. In addition to this, the color temperature must be known, must remain constant, and must correspond closely to the quality of light that is likely to be used in practical photography. These qualities allow the test strip to be exposed under conditions as close as possible to those that occur in practical use. When you base sensitivity measurement on a consistent factor that is known, the response of light-sensitive emulsions, under practical conditions, is predictable. Thus various emulsions may be compared to each other. You know that emulsions often change in apparent sensitivity (speed) with a change in the spectral composition (color) of the exposing light. Processing also has an effect on the speed of emulsions.

When incandescent lamps are used in sensitometers, they operate at a color temperature of about 3200 K. The color temperature of sunlight is about 5400 K. Therefore, you may need a filter to alter the color of the lamp, so it is equivalent to the spectral energy of sunlight.

Differences in time can also lead to errors due to reciprocity law failure. The EG&G sensitometer, used commonly in Navy imaging facilities, permits you to change the exposure times as well. The exposure can be changed from 1/100 second to 1/10,000 second. This allows you to test the reactions of emulsions to various exposure times.

A sensitometer is used to produce a logarithmically graded series of exposures with values that are already known. These are generally arranged in steps from low to high. A part of the strip is left unexposed, so the gross density of the material itself may be determined.

The device or method used to vary the amount of exposure must also meet certain requirements. The device should be able to produce an exposure range that conforms closely to that found in actual practice, to be accurate, to be consistent, and to have no significant effect on the color quality of light. A step tablet is used in a sensitometer for this purpose.

## Step Tablet

The 11- and 21-step step tablets are most commonly used in sensitometers. These step tablets are comprised of a series of neutral-density filters with densities that range approximately from 0.05 to 3.05. On an 11-step step tablet, one f/stop exposure difference (or 0.30 density difference) exists between each step of the tablet. On a 21 -step step tablet, a 1/2 f/stop exposure difference (or 0.15 density difference) exists between each step of the tablet. Selection of a step tablet should be based on the emulsion latitudes and contrast differences in pictorial and copy films and papers. A 21-step step tablet is used normally for long-scale films, and a 11-step step tablet is used for short-scale films and printing papers (fig. 2-2).

## Processing Sensitometric Strips

Sensitometric strips (scensi-strips) are made by processing under controlled conditions of time, temperature, agitation, and chemical activity. This holds true whether the material is black and white or color. Black-and-white control strips are normally made in the lab, while color control strips are obtained from the manufacturer of the material being processed.

When you are machine processing control strips or sensi-strips, they can be attached to either a roll of film or a leader. To reduce the likelihood of bromide drag, ensure the leading edge of the sensi-strip has received the least amount of exposure in the sensitometer. Following this procedure, the strip goes through the processing machine tanks with the rest of the roll and receives the same processing. Remember that all steps in the processing of control strips and film are important if the process is to maintain high standards and uniformity of results. Each step in the entire process must be carried out as carefully and as systematically as possible with uniform times and handling techniques in each step from exposure to drying.

Refer to figure 2-3 for the relationship between the sensitometer, step tablet, and sensi-strips.

## CHARACTERISTIC CURVES

The characteristic curve shows the relationship between the exposure and the density, resulting from



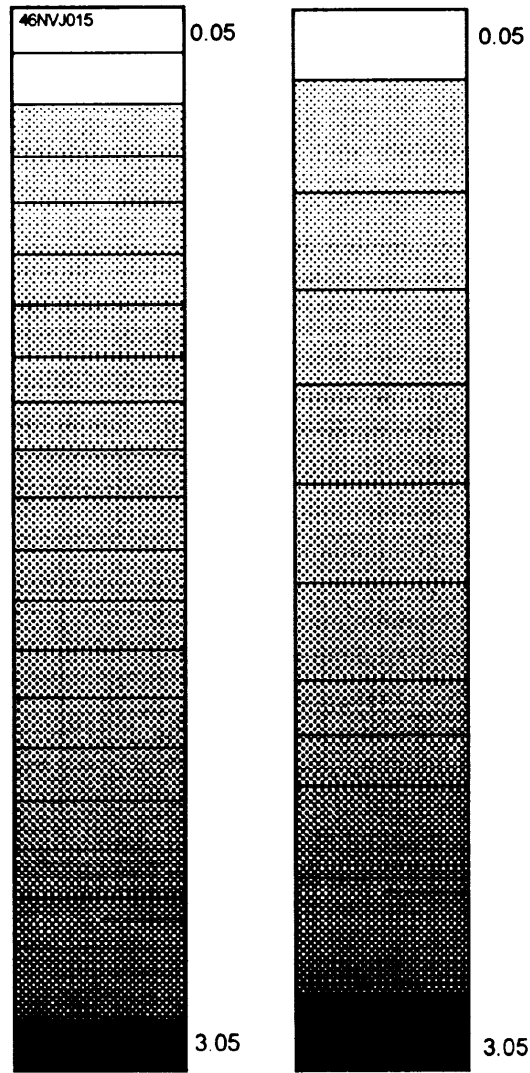

Figure 2-2.—Step tablets.

the development processes. It is also called an H and D, D log-H, D log-E, or sensitometric curve.

Characteristic curves are plotted on graph paper. The vertical axis represents the amount of density, created by each step of exposure. These logarithmic values are read directly from a densitometer. The density values increase from the bottom to the top of the graph.

The horizontal axis of the graph is used to indicate log exposure (log H). The horizontal axis represents the amount of exposure the material received. Exposure must be converted to a logarithmic value, so the scale of density and exposure

are uniform. Exposure increases from left to right on the horizontal axis.

When the sensitometric strip is made with the Eastman Kodak No. 2 Step Wedge (21 step), there is an increase of about 0.15 in density between each step or an increase of 50-percent density. The individual steps should be calibrated by reading the step on a densitometer for the greatest accuracy. The densities of steps range closely from 0.05 to 3.05, but the density of the individual steps may vary slightly. For illustration purposes, the step tablet used in the following example has exactly 0.15 density differences between each step.

## PLOTTING CHARACTERISTIC CURVES

Once the graph is labeled, use a densitometer and read the densities of the sensitometric strip and plot them on the graph to form a curve. Assume that the sensitometric strip has the following density readings:

<b>Sensi-strip Step</b>	<b>Density Reading</b>
1	0.18
2	0.19
3	0.21
4	0.26
5	0.32
6	0.40
7	0.49
8	0.59
9	0.70
10	0.79
11	0.90
12	0.99
13	1.10
14	1.20
15	1.30
16	1.40
17	1.50
18	1.60
19	1.70
20	1.78
21	1.82
<b>Gross fog</b>	<b>0.12</b>

To plot these densities on the graph, find the density value reading of step 1 and place a dot at that point. Do the same with steps 2 through 21, as shown in figure 24. After plotting all the readings, connect the plotted points with a french curve and straightedge (fig. 2-5). You do not necessarily want to connect

each plotted point. The resulting curve should be a smooth, flowing line with no angles apparent.

Remember to label every graph with all the pertinent information, because information that is not recorded on the graph may be lost or forgotten. This

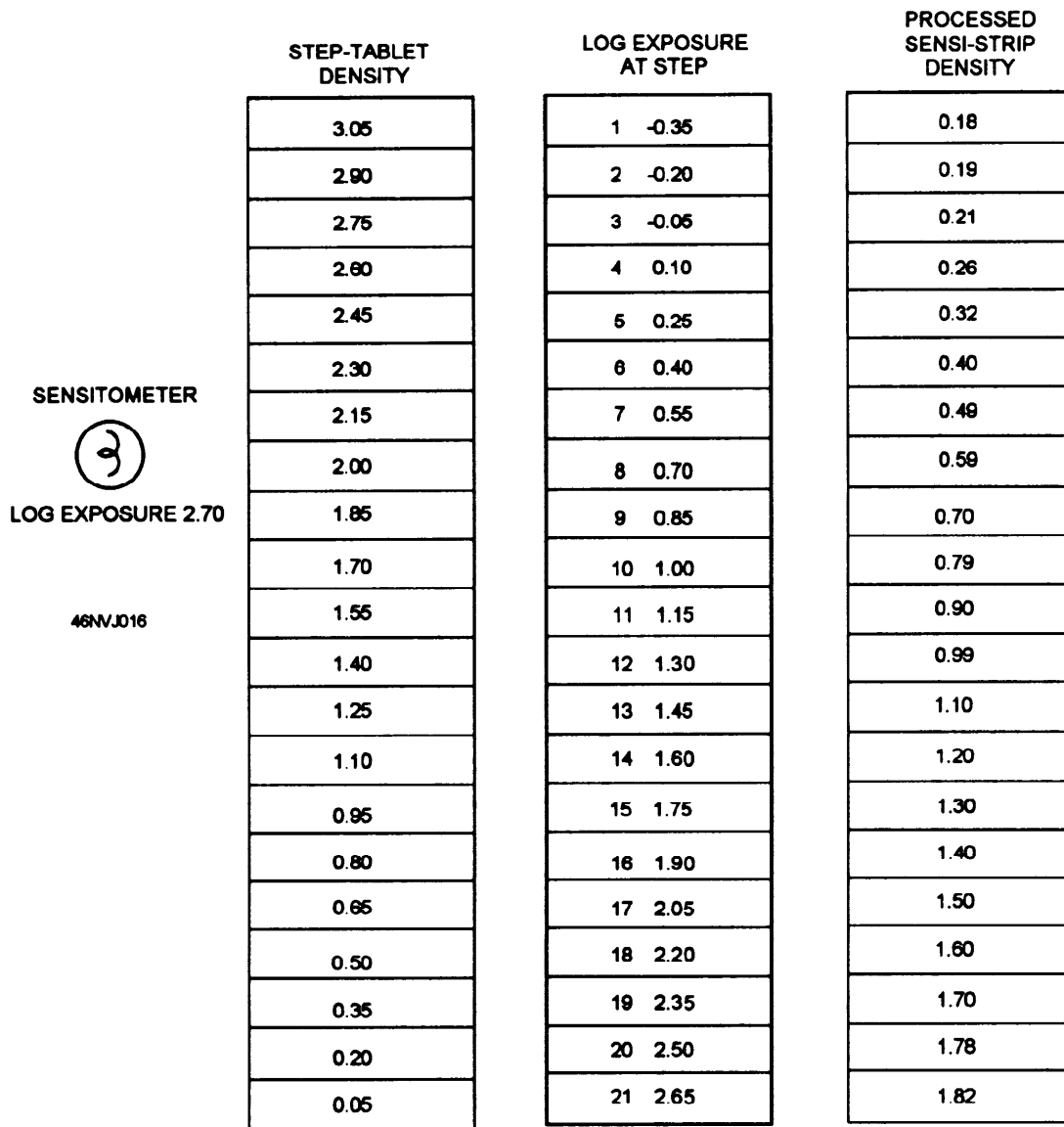

Figure 2-3.—How a sensitometer is used to produce sensitometric strips.

information should include the type of developer, the development temperature, the development time (or machine speed), the type of film, the agitation used, and so forth.

### ANALYZING CHARACTERISTIC CURVES

By analyzing a characteristic curve, you can determine the effective speed of the emulsion, the contrast, the latitude, and the useful exposure range. Figure 2-6 at the end of the chapter shows a typical characteristic curve with the various parts and their names. Refer to figure 2-6 frequently as you proceed through this chapter.

The speed of the material being evaluated determines the position of the curve regarding log exposure (log H) or horizontal axis. The length and slope of the straight-line section are the main variations to the shape of the curve. All densities on the straight-line section of the D-log H curve increase proportionally with an increase in development time. The slope or gradient of the straight-line section of the curve also increases, as development is increased; that is, it gets steeper.

### Toe Section

The toe section (fig. 2-6) is a concave, rising portion of the curve that gradually increases in

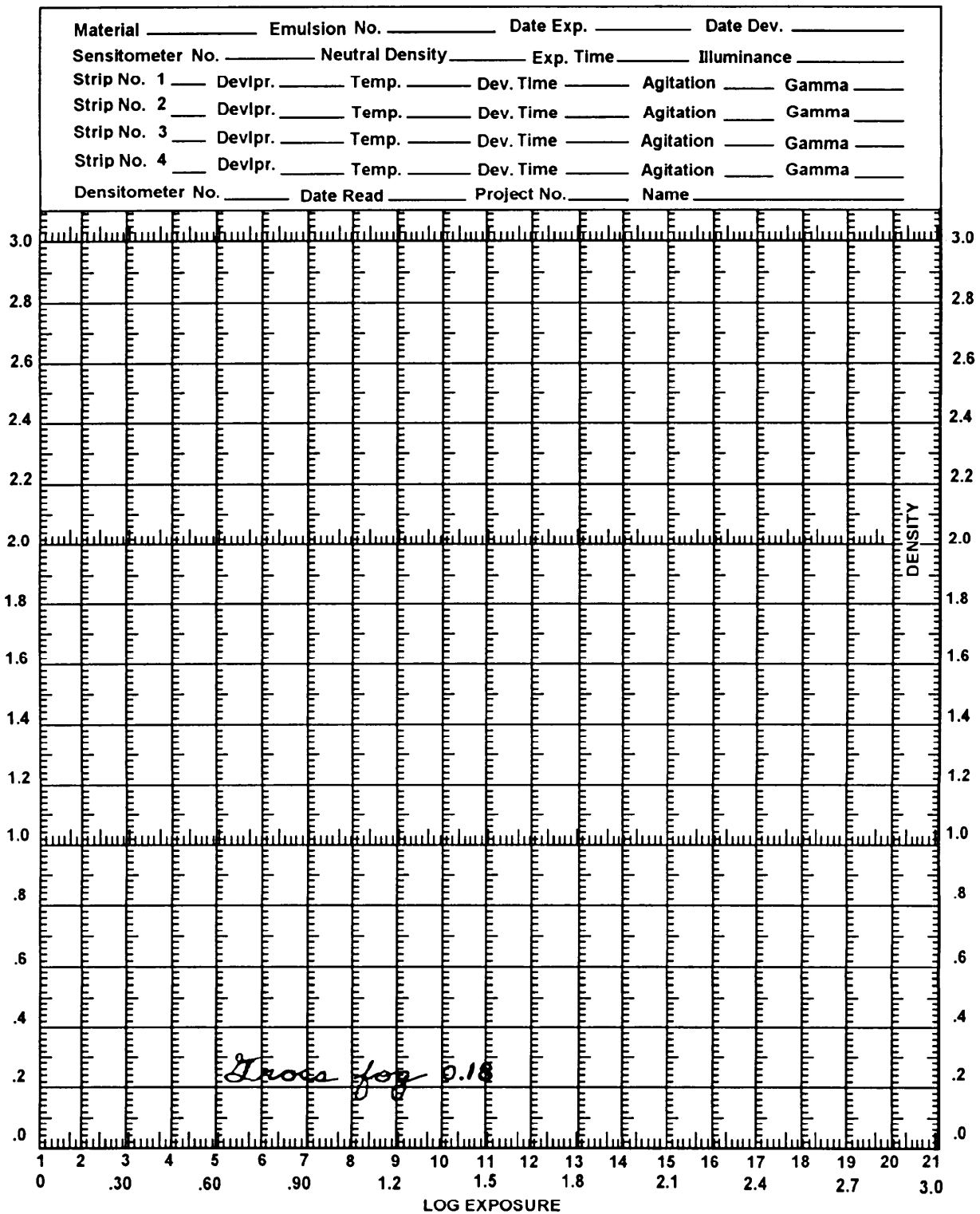

Figure 2-4.—Plotting points for the characteristic curve.

density. This section is defined as a region of *unequal rise*, because the density does not increase equally for equal increases in exposure. Subject tones exposed in this section are reproduced with small,

unequal density differences. Exposures made in this section of the curve lack detail. For ground pictorial photography, satisfactory exposures are made when the shadow areas of the subject fall in the toe area.

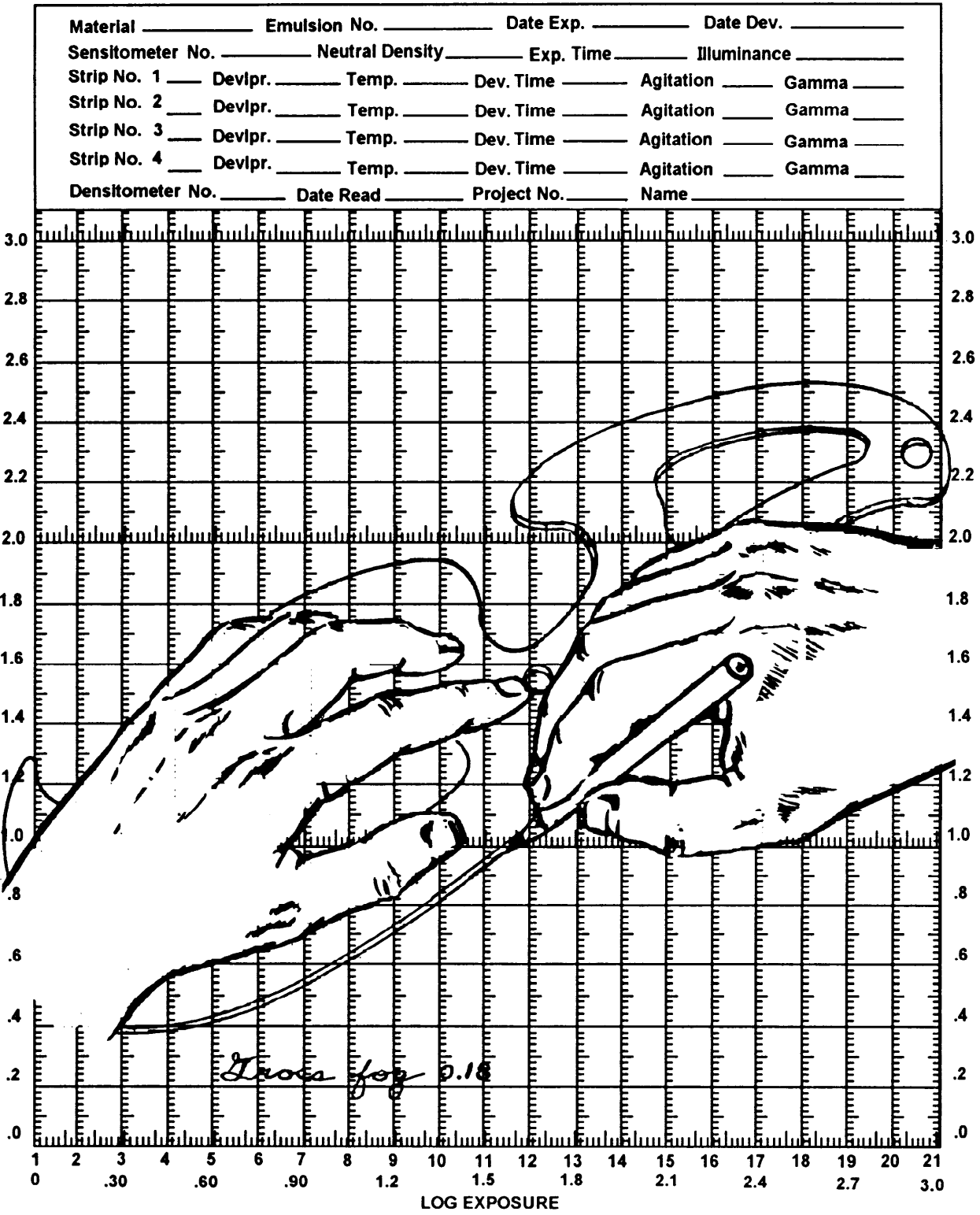

Figure 2-5.—Drawing the characteristic curve.

Notice in the toe section of the illustration (fig. 2-6) that steps 1 through 4 do not show a change in density. This indicates that the film has not been

affected by light, and the density is not a result of exposure, but of the emulsion base and the emulsion fog (gross fog) present in all emulsions. Step 5 shows

a slight increase in density. This is called the *threshold* and indicates the least amount of exposure that will produce a noticeable change in density.

### **Straight-Line Section**

Further to the right (fig. 2-6) is a section of the curve that appears to be a straight line. Note that in many cases there will not be a well-defined straight line. This section of the curve has a constant slope, and in addition, the gradient of the slope here is greater than in any other part of the curve. In the straight-line section of the characteristic curve, there is an equal increase in density for an equal increase in exposure. This is the most important part of the curve. Subject exposures that fall on the straight line produce constant density differences.

### **Shoulder Section**

The upper section of the curve (fig. 2-6) is a convex, curved line that gradually decreases in slope. This section of the curve is called the *shoulder*. Like the toe area, equal changes in exposure do not produce equal differences in density. Tones of the subject falling very far up in this section are blocked; that is, reproduced with densities too heavy for printing or maximum detail. For normal exposures, bright highlight tones of the subject tend to be reproduced in the shoulder section of the curve.

### **Exposure**

Although sensitometry is a tool of the lab technician, it also is significant to the photographer. Notice how this applies to exposing film. For example, when a uniformly lighted gray card is photographed, there is a single exposure, corresponding to a single point somewhere on the log-H axis. When the light on the surface of the gray card is increased and another photograph is made (maintaining the same camera settings), the exposure and the log H also increase. This causes a shift to the right on the log-H axis. There should be a corresponding increase in density, and the two factors again should plot on the characteristic curve.

Extending this to a scene with a large number of luminances (reflectances) or high-luminance ratio, the tonal differences in the subject, the lighting, and the camera settings determine the film exposure that produces varying amounts of densities. These density differences must be related to the log-H differences

that produce them; that is, density differences in the negative must be considered in their relationship with the tones of the subject.

The density differences in a negative can be partially controlled by placing the exposures corresponding to the subject tones in the correct section of the characteristic curve. This is done by adjusting the camera settings correctly, providing that the range of tones in the subject is not too great.

### **Emulsion Latitude**

The emulsion latitude is the exposure range where there is a proportional relationship between density differences and log-H differences. In other words, it is simply the range of exposure covered by the straight-line section of the characteristic curve (fig. 2-6). The latitude of an emulsion, therefore, determines the brightness range of the subject that can be reproduced proportionally. Latitude may be expressed either as the difference in log-H values between the two extreme points of the straight line or as the exposure ratio between these same two points.

The emulsion latitude of light-sensitive materials varies according to the purpose for which it was designed—from 1:400 or more for long-scale panchromatic film, and from 1:20 or less for process film. For any given emulsion, the emulsion latitude varies according to the contrast. The emulsion latitude decreases as the contrast increases.

### **Log Exposure Range**

The useful exposure range includes part of both extremities (toe and shoulder) as well as the straight-line section of the curve. For ground pictorial film the useful exposure range of a sensitized material is greater than the emulsion latitude, since portions of the toe and shoulder regions of the curve are used without sacrificing print quality.

The approximate lower limit of the useful exposure range is the density point on the characteristic curve that is not less than 0.10 above the gross fog of the film. This point is referred to as *minimum useful density*. The upper limit is generally located at 90 percent of maximum density on the shoulder of the curve and is referred to as *maximum useful density*. In practice, many photographers use a

much lower upper limit because of the high densities involved

## Exposure Latitude

Exposure latitude is the allowable range of exposures for a given photographic emulsion. It varies with the brightness range of a scene. Film with a wide exposure latitude permits a greater variance of exposure and still produces an acceptable negative.

Exposure latitude is associated with the useful log-exposure range and can be thought of as the margin of camera exposure error. Scenes that have a relatively low-luminance ratio and are photographed using a long-scale film have more exposure latitude than a scene with a high-luminance ratio using the same film. For example, you are photographing a subject with a luminance ratio of 60:1. This subject requires a log-exposure range of 1.78 (log of 60 = 1.78). The useful log-exposure range of the film/development combination is 2.70. This leaves a difference in logs of 0.92 (2.70 - 1.78 = 0.92). In this example, the exposure latitude is about three f/stops (remember, one f/stop = 0.30). Normally, the lower the contrast of the scene and the faster the film, the greater is the exposure latitude.

Modern high-speed films have an overall exposure latitude of several stops for an average subject. However, regardless of the brightness range of the scene, color reversal and very slow black-and-white and color negative films have very little exposure latitude because of their increased inherent contrast. Thus the range of exposure lies within a narrow limit that may be less than one-half to one f/stop.

## Gamma

In technical terms, gamma (signified by the Greek letter  $\gamma$ ) is a sensitometric quantity that indicates the slope or gradient of the straight-line section of the characteristic curve. It is interpreted as a measure of the contrast reproduced in a negative image; that is, the ratio of negative contrast to original subject contrast for a given range of tonal values. It measures the degree of development of photographic materials, since changes in development affect contrast or affect the slope of the curve. Exposure changes, as explained previously, shift the position of the points right or left on the log-H axis without altering the slope of the curve. Thus the tendency is for exposure to control the density and development to control the contrast of the image reproduced. Remember the

expression, "Expose for shadow density—develop for contrast."

Mathematically, gamma is the ratio of height gained to distance traveled in a horizontal direction. In determining gamma, the height is density (D), and the horizontal base is log exposure (log H). An ideal film and processing might produce an increase of .3 density for each .3 increase of exposure. This ratio is 0.3:0.3, or 1.0.

Most ground pictorial subjects call for film with a gamma value around 0.75, varying from 0.65 to 0.90. Such emulsions record the wide range of tones present in outdoor scenes. In practice, each of the main groups of negative materials has its own individual characteristics. Gamma is useful to you, because it indicates how the photographic material responds to changes in exposure and processing.

From the previous discussion, you may have noticed that gamma is definable in different ways. Some more useful definitions include the following:

- Gamma is the numerical measure of the contrast reproduced in an image.
- Gamma is a numerical measure of the degree of development (for a given material).
- Technically, gamma is the slope of the straight-line section of the characteristic curve.

Once a characteristic curve has been plotted, gamma can be determined in a number of ways. Two of the most common methods are as follows:

● Basic method—This method shown in figure 2-7 involves the ratio between densities and the exposures that produced them. Any two points on the straight line are chosen. (More reliability results when the points are widely separated.) Gamma is the result of dividing the change, or difference in density, by the difference in log H between the two points. The formula is as follows:

$$\gamma = \frac{\Delta D}{\Delta \log H} \quad \text{or} \quad \frac{D_1 - D_2}{\log H_1 - \log H_2}$$

where

$\Delta$  (Delta) = Symbol for change or difference

Material _____	Emulsion No. _____	Date Exp. _____	Date Dev. _____	456NVJC20
Sensitometer No. _____	Neutral Density _____	Exp. Time _____	Illuminance _____	
Strip No. 1 _____	Devlpr. _____	Temp. _____	Dev. Time _____	Agitation _____
Strip No. 2 _____	Devlpr. _____	Temp. _____	Dev. Time _____	Agitation _____
Strip No. 3 _____	Devlpr. _____	Temp. _____	Dev. Time _____	Agitation _____
Strip No. 4 _____	Devlpr. _____	Temp. _____	Dev. Time _____	Agitation _____
Densitometer No. _____	Date Read _____	Project No. _____	Name _____	

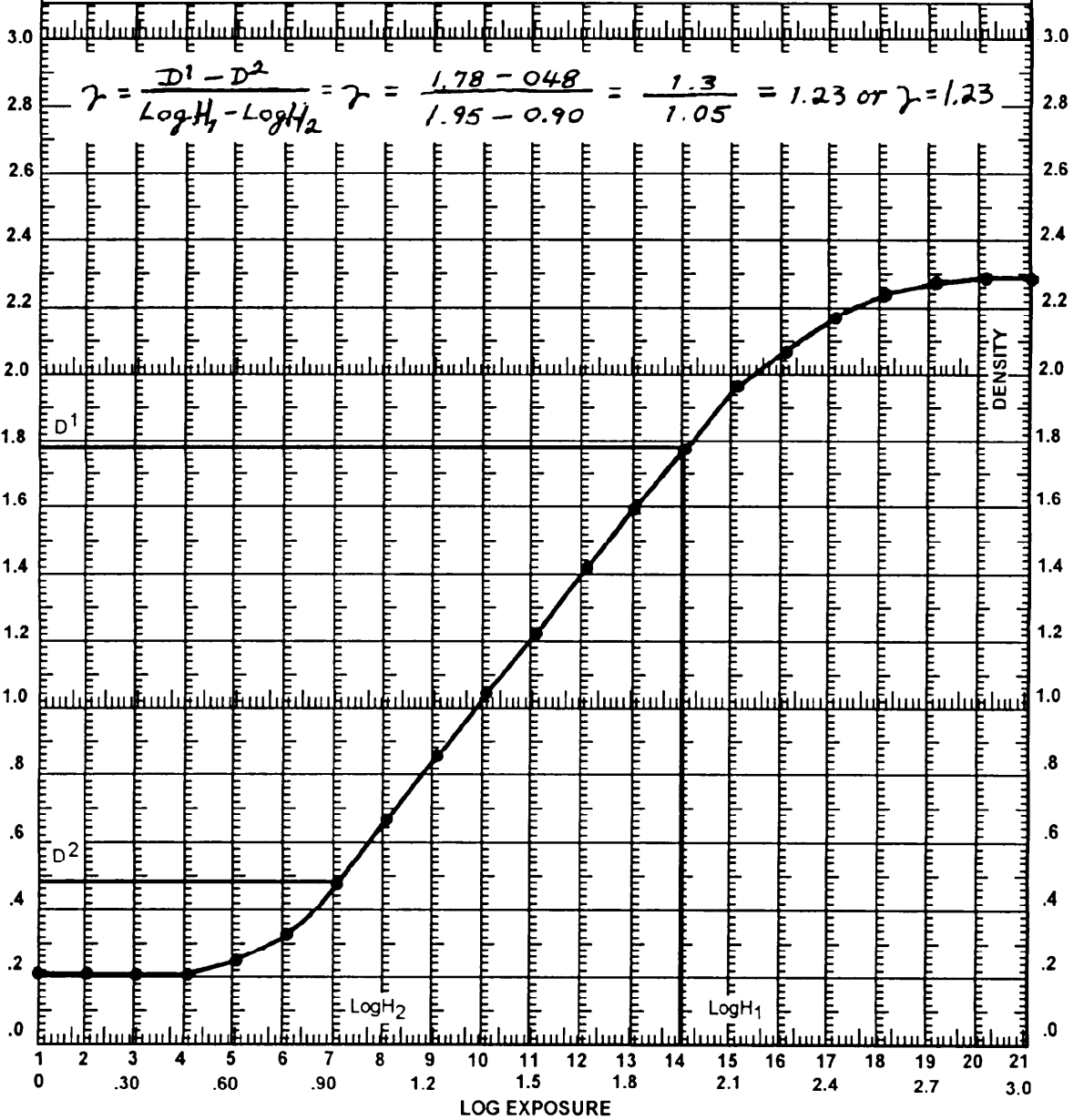

Figure 2-7.—Computing Gamma.

The values of  $D_1$ ,  $D_2$ ,  $\log H_1$ , and  $\log H_2$  are read directly from the graph. The mathematical computation for this method is shown at the top of figure 2-7.

● Quick method—This method uses a gamma gauge (fig. 2-8). The arrow of the gauge is placed on the straight-line section of the curve with its base line parallel to the log-H axis. Gamma is indicated where



Material \_\_\_\_\_ Emulsion No. \_\_\_\_\_ Date Exp. \_\_\_\_\_ Date Dev. \_\_\_\_\_  
 Sensitometer No. \_\_\_\_\_ Neutral Density \_\_\_\_\_ Exp. Time \_\_\_\_\_ Illuminance \_\_\_\_\_  
 Strip No. 1 -- Devlpr. \_\_\_\_\_ Temp. \_\_\_\_\_ Dev. Time \_\_\_\_\_ Agitation \_\_\_\_\_ Gamma \_\_\_\_\_  
 Strip No. 2 -- Devlpr. \_\_\_\_\_ Temp. \_\_\_\_\_ Dev. Time \_\_\_\_\_ Agitation \_\_\_\_\_ Gamma \_\_\_\_\_  
 Strip No. 3 -- Devlpr. \_\_\_\_\_ Temp. \_\_\_\_\_ Dev. Time \_\_\_\_\_ Agitation \_\_\_\_\_ Gamma \_\_\_\_\_  
 Strip No. 4 -- Devlpr. \_\_\_\_\_ Temp. \_\_\_\_\_ Dev. Time \_\_\_\_\_ Agitation \_\_\_\_\_ Gamma \_\_\_\_\_  
 Densitometer No. \_\_\_\_\_ Date Read \_\_\_\_\_ Project No. \_\_\_\_\_ Name \_\_\_\_\_

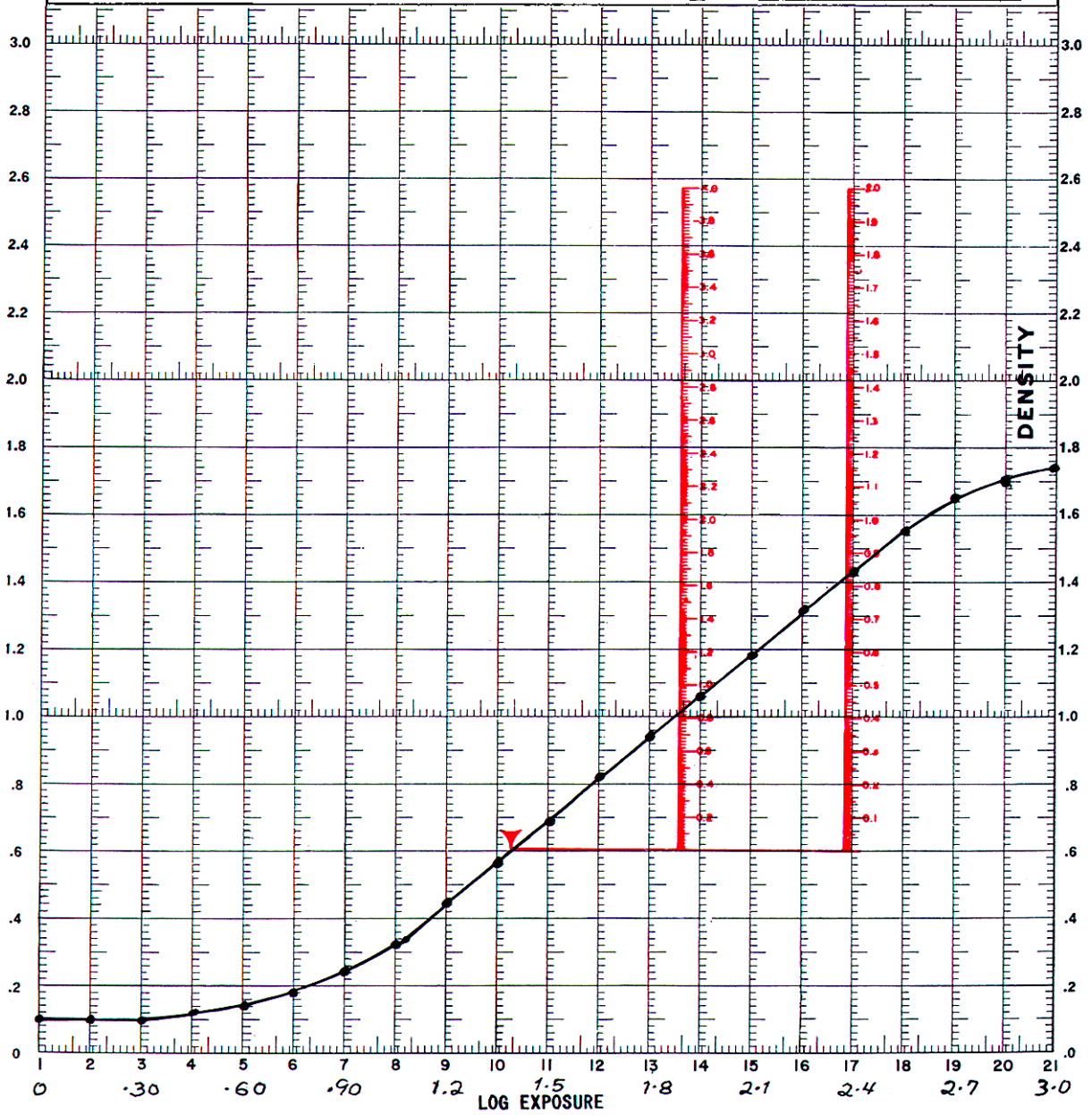

Figure 2-8—Using a gamma gauge.

the straight line intersects the scale. As you can see, the gamma for the plot is 0.82.

## CONTRAST

A negative contains several different contrasts. It has "total contrast," defined as the difference in density between the useful shadow and highlight densities in a negative. Total negative contrast is a useful index to determine what contrast printing filter to use. Total negative contrast is dependent upon factors, such as subject luminance ratio, camera exposure level, color of light, and gamma. Gamma is only one of the factors that controls the total contrast of a negative. In addition, a negative has other forms of contrast as follows:

- *Shadow contrast*—associated with the toe section of the characteristic curve and, therefore, unrelated to gamma.
- *Highlight contrast*—associated with the shoulder of the characteristic curve and gamma does not apply.
- *Midtone contrast*—associated with the straight-line section of the characteristic curve.

## GAMMA

Gamma, therefore, is not a measure of negative contrast, nor does controlling the gamma in different negatives ensure that they will all print with the same contrast printing filter. All of the frames on a roll of film may be developed uniformly to the same gamma; for example, 0.75. However, each negative probably has a different total contrast because of variations in subject luminance ratio, subject color, lighting, and so forth. "Contrast," therefore, is best defined as a range of densities produced by a combination of the subject luminance ratio and the amount of development given a film.

Film exposed on a cloudy bright (no shadows) or heavy-overcast day could be developed to a high gamma (for example, 1.6) and still produce a flat negative, because of the small luminance range of the subject being photographed. Another scene with a high-luminance ratio could be photographed and developed to a low gamma of say 0.50, yet the contrast of the negative could be so high that it requires a low-number contrast printing filter.

You should understand that even though a negative can have high-total contrast, there may be little contrast in the shadows when those shadows fall on the flat portion of the toe. When two films with the same characteristics are exposed to the same scene, at the same time, and each film is developed to a different gamma, more contrast can be expected in the negative developed to the higher gamma. This is true for those tones exposed on the straight-line section of the characteristic curve and to a lesser extent for tones exposed on the upperpart of the toe.

When the basic formula for determining gamma is examined,  $\Delta D$  (difference in density) may be considered the negative contrast (for the straight line) and  $\Delta \log H$  (difference in log H) the subject contrast. Gamma can then be considered as the *ratio* between negative and subject contrast. A negative that is developed to a gamma of 1.00 has, for all straight-line exposures, the same contrast range as the original scene. When the negative is developed to a lower gamma (for example, 0.50), it has only half as much contrast as the subject. Remember, this applies only to the straight-line section of the curve.

Gamma, however, is not always appropriate for measuring the effects of exposure and development. Gamma does not take into consideration that the toe of the curve is normally used for recording shadow tones in ground pictorial, continuous-tone film. Also, D-log H curves for different films have different toe lengths and toe shapes; consequently, film developed to a given gamma may not yield a uniform density range sufficient enough for ordinary continuous-tone photography. To provide a more uniform density range, you can use a form of averaging the gradient, called *contrast index*. However, in some applications where the characteristic curve has a long straight-line region and the image is recorded totally on the straight-line section of the curve, gamma is still a valid method of measuring density range.

In aerial photography, for example, it is desirable to record shadows, midtones, and highlights on the straight-line section of the characteristic curve. When all subject tones are recorded on the straight-line section of the curve, the greatest amount of tone separation is obtained in all areas of the image (shadows, midtones, and highlights). This provides the maximum amount of detail in all areas of the negative. A greater emphasis is placed on detail, rather than a "pretty picture," in most aerial photographic applications.

## CONTRAST INDEX

As you know, "contrast" means the range of densities produced by a combination of subject luminance ratio and the amount of development. The luminance ratio of the scene cannot be controlled outdoors and can be controlled only within limits in the studio. When the degree of development is controlled, one variable that affects negative contrast is practically eliminated. When films are developed to a given *contrast index* (CI) value, they can be made compatible with any printing system. Variations in contrast caused by different subject luminance ratios are then adjusted in printing by selecting the appropriate variable contrast printing filter. Controlled film development helps to produce a uniform standard of print quality, as well as to make printing easier and less costly in both time and materials.

Contrast index has the same uses as gamma. It is an index number that can be used for processing control purposes. When films or developers are compared, the test images should all be developed to the same contrast index. Obtaining a constant contrast index, like gamma, does not guarantee that all negatives will have the same total contrast or that they will all print similarly.

The contrast index is measured over that part of the D-log H curve used in exposing continuous-tone negatives correctly. CI is the *average* of the slope and is distinctly different from the straight-line slope of gamma. In this context, an average is the slope of a straight line drawn between two definite points on the curve. The straight line is drawn between two points on the D-log H curve that represents the highest (D-max) and the lowest (D-min) *useful* densities on the characteristic curve.

To determine the contrast index, you must use a transparent overlay on the D-log H curve. Refer to figure 2-9 at this time. To use this transparent contrast-index gauge, you must place it on the gross fog density line of the characteristic curve. The gauge is then moved right or left until the low-density arc intersects the toe of the curve, and the high-density arc on the shoulder of the curve reads the same value. This value is the contrast index. Figure 2-9 shows the proper use of a contrast-index gauge.

Since contrast-index gauges are not found in most imaging facilities, an alternative method is used to determine the contrast index of a characteristic curve. This method is not as accurate as using a contrast-index gauge, but provides an approximate value. To use this method, first locate the density point (in the toe area of the characteristic curve) that is 0.10 above B+F. Then, using a compass, align it on the log-H axis and spread it to a distance equal to 2.0 in logs. Place the point of the compass on the density point that is 0.10 above B+F and draw an arc on the curve. Finally, draw a straight line between the two points and determine the slope, using the same formula you used for gamma. The result is the approximate contrast index.

## CONTROL IN PROCESSING

The gamma or contrast-index value of a photographic material is not fixed. Both vary, depending on the process used. It is important for you to realize that the contrast obtained by development depends on the *amount of development*, rather than on the development time alone. To obtain an accurate gamma or contrast index, you must control the total amount of development carefully, such as developer temperature, developer strength, degree of agitation, and other variables.

The densities of a characteristic curve are changed by changes in development. Therefore, gamma and contrast-index values are useful as a measure of the degree of development. Gamma and contrast index vary directly with the degree of development; the greater the development, the higher the gamma or contrast index. This is true until the film is grossly overdeveloped. When film is grossly overprocessed, the contrast begins to decrease, because the unexposed silver halides have developed (increased gross fog) after the maximum density has "peaked" out. The point that the gamma or contrast index reaches its maximum level is known as *gamma (or CI) infinity*.

Gamma and contrast index are two important tools used in processing control. Films developed to the same value, for example, show comparable tone reproduction. When you want to determine whether processing is consistent, sensitometric strips are

Material \_\_\_\_\_ Emulsion No. \_\_\_\_\_ Date Exp. \_\_\_\_\_ Date Dev. \_\_\_\_\_  
 Sensitometer No. \_\_\_\_\_ Neutral Density \_\_\_\_\_ Exp. Time \_\_\_\_\_ Illuminance \_\_\_\_\_  
 Strip No. 1 — Devlpr. \_\_\_\_\_ Temp. \_\_\_\_\_ Dev. Time \_\_\_\_\_ Agitation \_\_\_\_\_ Gamma \_\_\_\_\_  
 Strip No. 2 — Devlpr. \_\_\_\_\_ Temp. \_\_\_\_\_ Dev. Time \_\_\_\_\_ Agitation \_\_\_\_\_ Gamma \_\_\_\_\_  
 Strip No. 3 — Devlpr. \_\_\_\_\_ Temp. \_\_\_\_\_ Dev. Time \_\_\_\_\_ Agitation \_\_\_\_\_ Gamma \_\_\_\_\_  
 Strip No. 4 — Devlpr. \_\_\_\_\_ Temp. \_\_\_\_\_ Dev. Time \_\_\_\_\_ Agitation \_\_\_\_\_ Gamma \_\_\_\_\_  
 Densitometer No. \_\_\_\_\_ Date Read \_\_\_\_\_ Project No. \_\_\_\_\_ Name \_\_\_\_\_

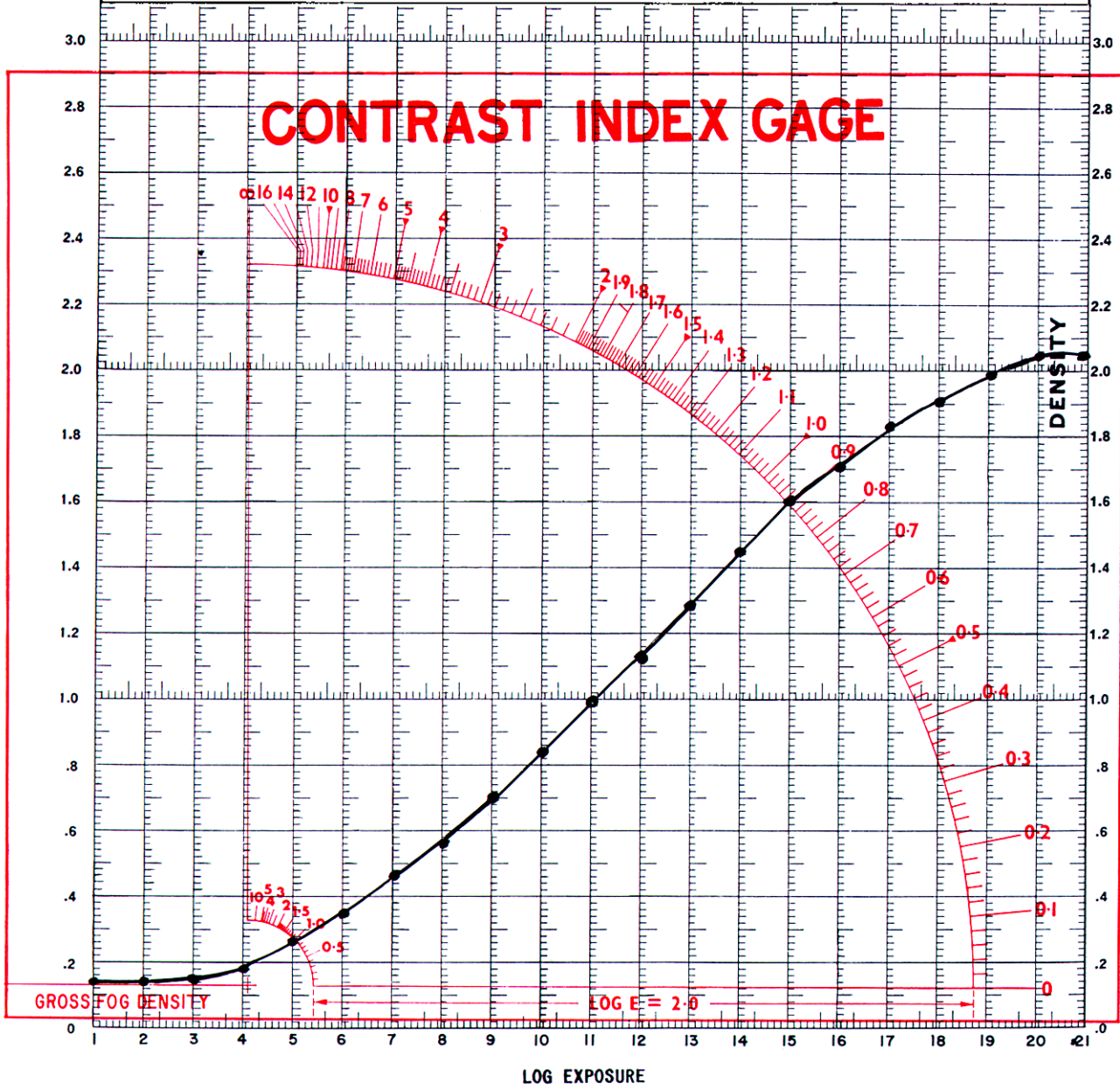

Figure 2-9.—Using a contrast-index gauge.

processed along with the production film and the gamma or contrast index is plotted. When the gamma or contrast index remains constant, the processing is consistent.

## USING GAMMA AND CONTRAST INDEX

For black-and-white ground pictorial photography, a gamma of about 0.65 to 0.90 or a contrast index of 0.56 to 0.60 is adequate for most printing systems. Some printing systems, such as those using specular light sources, require a lower CI. For these systems, a lower value may be more suitable. The best gamma or contrast index for a particular printing system can be determined only through practical tests. These tests can be made by developing several equally exposed films to different gamma or contrast-index values. The negative with a gamma or CI value that prints best on your printing system is then used. When using variable contrast paper, you should aim for negatives that print well with a No. 2 filter.

### Time-Gamma and Time-Contrast Index Curves

Time-gamma or time-contrast index curves are plotted to summarize the behavior of any film-developer combination. Time-gamma or time-contrast index curves are used to indicate the time of development required to reach a desired gamma or contrast index. Time-gamma and time-contrast index charts can be made to show the maximum gamma (gamma infinity) or maximum contrast index (contrast index infinity) obtainable with a given film-developer combination.

Figure 2-10 shows a time-gamma curve and the *family of curves* that produced it. A small graph is drawn in the upper left corner of the graph on which the family of curves is plotted. The horizontal axis of the small graph indicates time of development in minutes and the vertical axis indicates gamma or contrast index, as appropriate. The gamma or contrast index obtained from each sensitometric strip of the film being tested is plotted against the time required to produce it by placing dots in their proper position on the graph. A french curve is used to connect the dots.

To use the curves, select the required gamma or contrast index from the vertical column of the small graph, and read the development time needed from the

times given just below the base line, or horizontal axis. These times should be based on negatives made under average conditions. If the negatives subsequently developed are too low in contrast, choose a higher gamma, or contrast-index value. When the contrast is too high, choose a lower value.

The processing latitude is the range in times of development for any given tolerance in gamma or contrast index. The processing latitude may be found by determining the minimum and maximum gammas or contrast indices that are acceptable.

By examining the time-gamma or time-contrast index curve, you will notice that as development increases, gamma or contrast index also increases. This increase is rapid at first and then increases more slowly. After a period of time, there is little increase in gamma or contrast index, even though development is prolonged. This indicates that for any particular emulsion and development condition, the higher the gamma or contrast index, the greater the processing latitude. This also indicates that the lower the gamma or contrast index, the more precise processing conditions must be to obtain uniform development.

### Time-Temperature Charts

One of the primary factors affecting the amount of development and the formation of density of an image is the temperature of the developer. The higher the temperature, the greater the activity of the solution. As the temperature drops, the developing time must be increased. Since gamma or contrast index must also be considered, typical time-temperature charts include a gamma and/or contrast-index value that varies according to development time and temperature. By consulting a time-gamma or a time-contrast index temperature chart, you can determine the proper developing time under varying conditions. These charts are published by film manufacturers and can be seen throughout the *Photo-Lab Index*. Figure 2-11 is a typical time-gamma chart. To use a time-gamma or time-contrast index temperature chart, follow the line indicating the temperature at which you are processing until the desired gamma or contrast-index line is intersected. From this point, drop straight down to the time of development line. The intersection of the vertical line and the time of development line indicates the proper developing time at the recommended agitation. For example, using figure 2-11, assume the film is to be processed at 70°F to a gamma of 0.90. Find 70°F and follow the horizontal

46NVJ023

Material \_\_\_\_\_ Emulsion No. \_\_\_\_\_ Date Exp. \_\_\_\_\_ Date Dev. \_\_\_\_\_

Sensitometer No. \_\_\_\_\_ Neutral Density \_\_\_\_\_ Exp. Time \_\_\_\_\_ Illuminance \_\_\_\_\_

Strip No. 1 \_\_\_ Devlpr. \_\_\_\_\_ Temp. \_\_\_\_\_ Dev. Time \_\_\_\_\_ Agitation \_\_\_\_\_ Gamma \_\_\_\_\_

Strip No. 2 \_\_\_ Devlpr. \_\_\_\_\_ Temp. \_\_\_\_\_ Dev. Time \_\_\_\_\_ Agitation \_\_\_\_\_ Gamma \_\_\_\_\_

Strip No. 3 \_\_\_ Devlpr. \_\_\_\_\_ Temp. \_\_\_\_\_ Dev. Time \_\_\_\_\_ Agitation \_\_\_\_\_ Gamma \_\_\_\_\_

Strip No. 4 \_\_\_ Devlpr. \_\_\_\_\_ Temp. \_\_\_\_\_ Dev. Time \_\_\_\_\_ Agitation \_\_\_\_\_ Gamma \_\_\_\_\_

Densitometer No. \_\_\_\_\_ Date Read \_\_\_\_\_ Project No. \_\_\_\_\_ Name \_\_\_\_\_

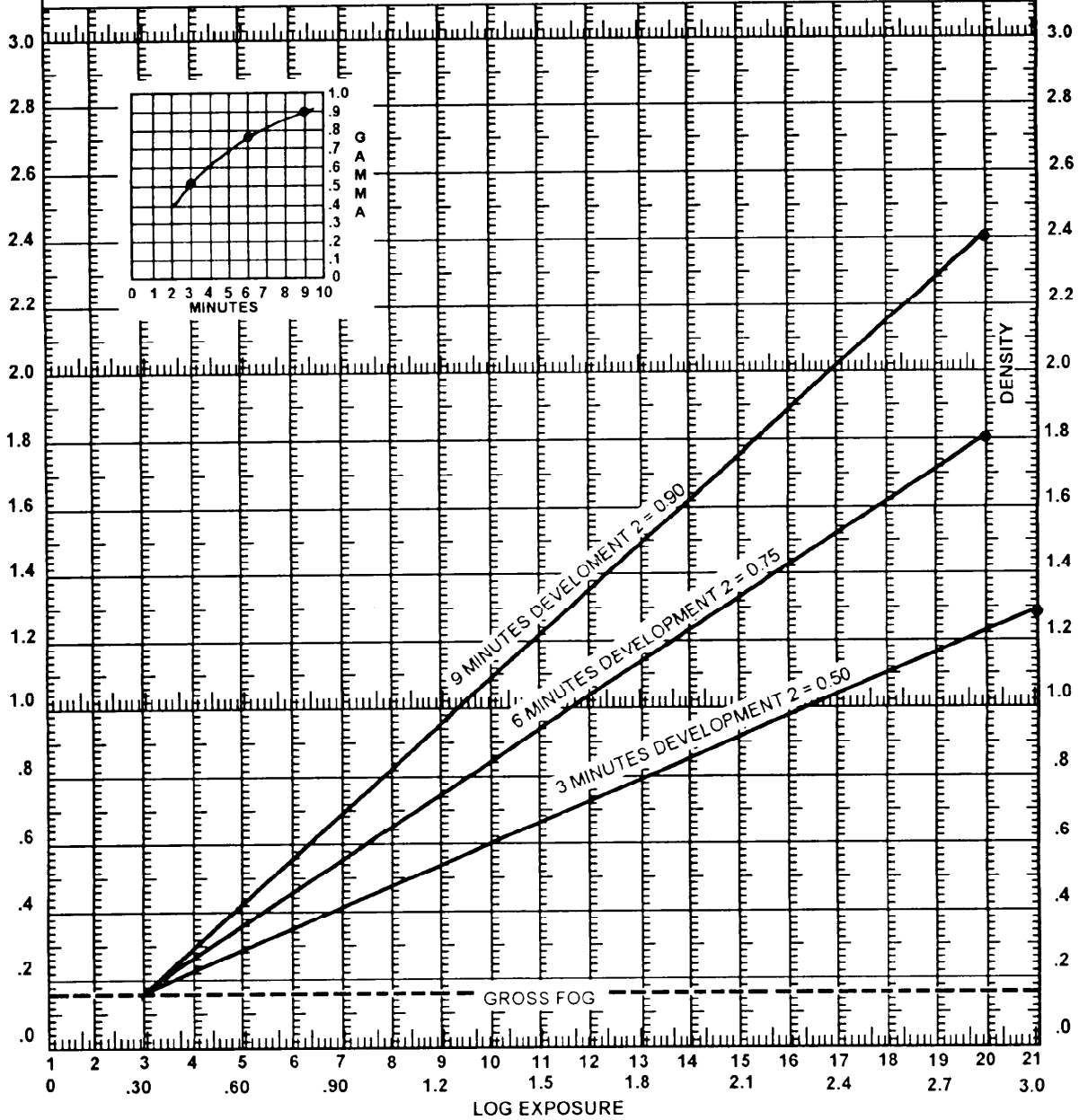

Figure 2-10.—Time-gamma and family of curves.

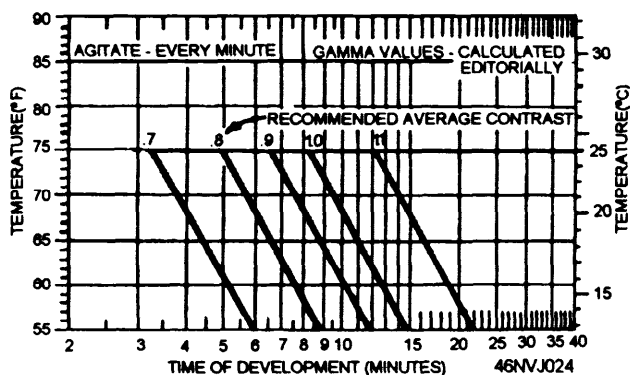

Figure 2-11.—Time-gamma temperature chart.

line until it intersects the bold line labeled .9 (0.90 gamma). From this point, drop straight down to the time of development line and read 7.5. It takes 7 1/2 minutes of developing time at the recommended agitation.

## CHEMICAL QUALITY ASSURANCE

The equipment and methods used presently for mixing photographic solutions are the result of changes that have taken place over many years. These improvements are made to keep pace with improved sensitized materials, processing equipment, and environmental regulations.

Substandard solutions make it impossible to operate a processing system within controlled limits. The preparation and use of photographic solutions must be a systematic procedure based on accurate measurement and standardized methods. High-quality standards can be achieved only when the conditions of exposure, chemistry, and processing are all within operating tolerances. Then results are predictable.

In certain critical processing areas, chemical analysis is used to check solutions before and during use. This helps us to keep chemicals up to standard. Analysis of the components of processing solutions is often used as a basis for discarding solutions or adjusting their composition for future use. These procedures are used to determine proper replenishment rates to promote the efficient use of chemicals. Quality assurance procedures are implemented, so solutions are mixed, used, and discarded properly.

## Chemical Analysis

Much of the chemical analysis performed is accomplished by using common sense. Practices, such as cleanliness, accuracy, and proper preparation of solutions, should be observed at all times. Contamination can ruin a developer which, in turn, could ruin your images. Things, such as dirt and dust, in the solution can cause artifacts on the film.

Before equipment is used for mixing and measuring chemicals, you should clean it thoroughly. Use a good-quality medium-strength detergent to wash glassware and other vessels. Be sure that all washed items are rinsed well with clean tap water. Keep the entire area clean to prevent contamination and ensure accuracy.

Some of the more common chemical analysis methods you will use are as follows:

- Determining pH
- Measuring specific gravity
- Sensitometric testing

Although there are several reasons for certifying photographic solutions, the principal objective is to get desirable, predictable, and consistent results.

Control of a photographic process requires that the chemical activity of the solutions be maintained. Chemical analysis procedures used to indicate chemical activity are valuable only when the samples analyzed are representative of the processing solutions. The analysis of a sample taken improperly may do more harm than good in controlling the process.

Processing solutions may be clouded or contain floating particles, dispersed oil droplets, or a precipitate. Even a clear solution may have different concentration levels in various parts of a processing tank; for instance, the chemical composition at the point where the film enters may not be the same as in other parts of the tank. To compensate for this, you must use a prescribed procedure, so all the samples are taken from the same location, such as from a point near the tank overflow. These samples should be representative of the solution at an established



sampling point, so successive analyses will indicate variations in the chemical composition.

Before sampling large batches of newly mixed photographic solutions, allow sufficient time for all the chemicals to dissolve properly, generally about 30 minutes to an hour.

You should draw a sample 1 inch below the surface of the solution with a pipet. In general, a sample bottle should not be shaken, and it should be allowed to stand for 10 minutes after the sample is taken from the processing solution. This wait allows large particles to settle or turbidity (caused by aeration) to clear.

### **Chemical Certification**

The chemical certification of processing solutions seldom requires a complete chemical analysis. Ordinarily, determining the pH and the specific gravity of the solution is enough, particularly when these tests are followed up with valid sensitometric tests.

**CERTIFYING THE pH OF SOLUTIONS.**—pH is one of the first tests made of a photographic solution. The pH of a solution is the negative logarithm of the hydrogen ion concentration. The electrical potential between the glass electrode of a pH meter and the solution surrounding it indicates the hydrogen ion concentration.

The pH value of a solution changes with temperature; therefore, to obtain a reproducible pH value, you must standardize the temperature. Generally, you make pH measurements at the same temperature that the photographic process is operated. A change of 10°F produces a pH change of approximately 0.10 in a processing solution at a pH of 10.5 and a change of approximately 0.20 at a pH of 13.0. Thus temperature control is more important at higher pH values. To properly use, calibrate, and adjust the meter consult the instruction manual or the particular pH meter you are using.

When certifying the pH of a solution, you can take the pH reading of only one sample or you can read several samples. Of course, the more samples you read, the more reliable your certification. Usually, you must determine the pH value of more than one sample. After four samples have been read, the meter should be cross-checked, then standardized.

Also, remember that no more than 15 minutes should elapse between any pH meter standardization or cross-check.

When using the multiple sample procedure, take the pH for each sample and average the values. Check the average value against the standard pH for that solution. When the pH is within limits, enter the value in the appropriate location on the certification sheet. When the pH is not within limits, further investigation is necessary.

**CERTIFYING THE SPECIFIC GRAVITY OF SOLUTIONS.**—Many applications of specific gravity are used in certifying a solution; for example, the actual dilution of a developer is obtained by comparing a fresh developer to a used one. Another application may be to compare a fresh fixing bath to a used one. Since the silver content of a fixer increases with use, it is logical to assume that a change in specific gravity will occur. Through experience, you will be able to establish upper- and lower-control limits for specific gravity of the various solutions needing such a check.

Specific gravity tolerances are provided by the manufacturer of photographic processing solutions. The specific gravity must be taken at the temperature recommended by the manufacturer, because temperature affects the specific gravity of a solution. Specific gravity standards for black-and-white processing solutions are set at 70°F, because many of these solutions are used in 70°F surroundings.

By themselves, the specific gravity readings you take are not enough to tell what is wrong. They simply indicate a change. So, further testing is required. When a developer is being replenished properly, specific gravity remains constant. If the flow of replenisher stops, a change of specific gravity will become evident. Replenisher flowmeters should indicate such a problem, but a backup check of specific gravity and pH, along with control strips, are recommended as well.

**SENSITOMETRIC CERTIFICATION OF SOLUTIONS.**—Once the developer has been mixed, a sensitometric strip should be processed to check the developer solution. Assuming the pH and specific gravity measurements of the developer are within tolerance, this test can certainly validate the activity of the developer.



When you are using a new developing solution, time-gamma or time-contrast index charts (as appropriate) must be developed for the variety of films to be processed in it. Given time, temperature, and agitation for each particular film in the developer, you will be able to see the results on these time charts.

After the developer solution has been proven, you should process a sensitometric strip with each processing run. Each sensitometric strip should be read with a densitometer and plotted on the appropriate process-monitoring chart. As a minimum, you should process and plot a control strip after start-up and before shut down or at the beginning and end of each work shift. Once the densities are recorded and plotted, an accurate graphic representation of the activity of the process is provided.

### QUALITY ASSURANCE CONTROL CHARTS

In photographic processing, control charts are used to monitor the status of specific solutions and the physical process. A list of numbers can be studied carefully to see whether they are out of line; however,

when the numbers are plotted on a chart, you can see instantly whether there is data out of order.

Photographic quality assurance control charts can be prepared for gamma or contrast index, minimum and maximum density (D-min and D-max), average density ( $\bar{D}$ ), gross fog, temperature, pH, specific gravity, or any other variable that may be required by your quality assurance program. To be useful in your quality assurance program, you must collect and record data relative to these and other specific factors. From the recorded data, you can calculate the mean or average, and determine the upper and lower limits.

If, for example, the control gamma in an aerial film processor is 1.50 and the desired average density is 1.65, you must have a method for indicating when the gamma or  $\bar{D}$  varies to the point where the end result is no longer desirable. When the gamma tolerance limit is  $\pm 0.05$  and the  $\bar{D}$  tolerance limit is  $\pm 0.07$ , the control chart appears as shown in figure 2-12.

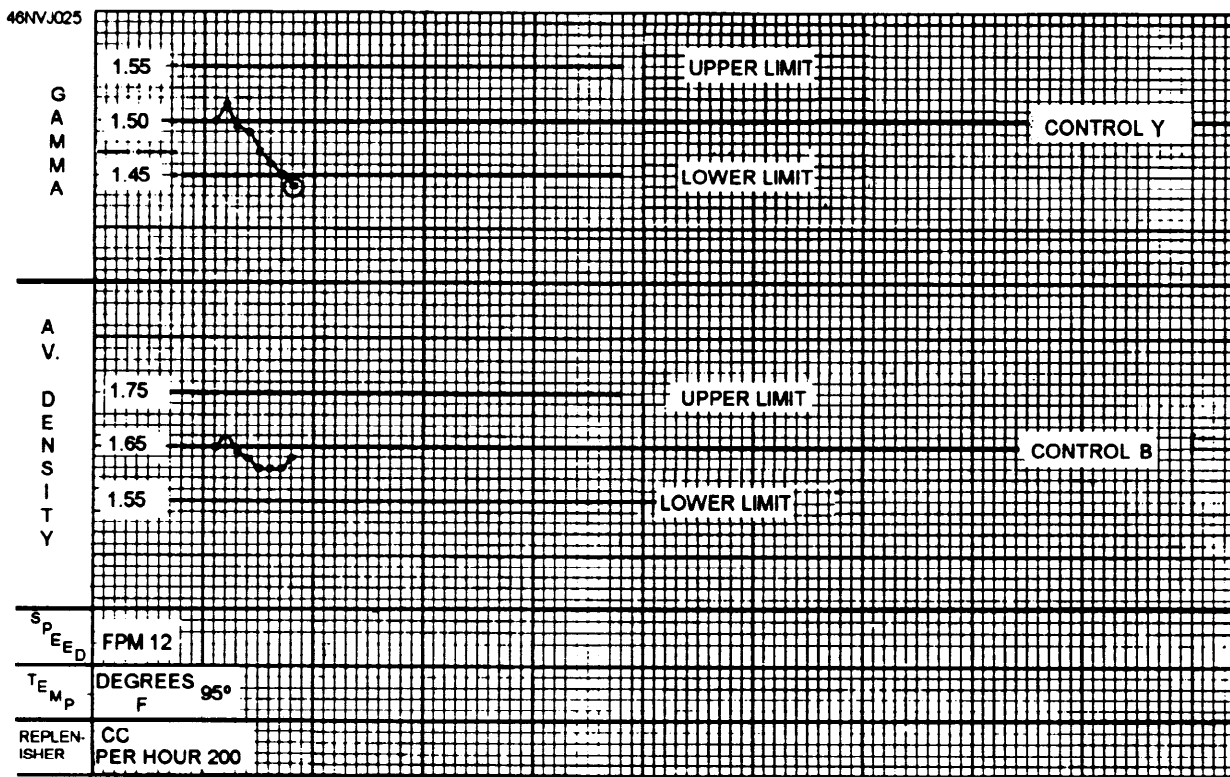

Figure 2-12.—Control chart.

From each processing run, you should plot the gamma and  $\bar{D}$  on the chart. You should write other data, such as processing time (or machine speed), temperature, rate of replenishment, and amount of film processed, on the control chart. After connecting the dots, you will know what the processor is doing and the direction in which the process is going.

Remember that the existing tolerance or control limits, once set, should not be left there indefinitely. You should continually strive to improve the degree of control and, to do so, reestablish closer control limits periodically.

The amount of information you can plot on control charts depends on several factors that may include, but are not limited to, the following:

- The product quality required
- The equipment available
- Personnel available and trained for QA duties

You are not expected to monitor all the variables that are listed. Also you are not limited on what you can monitor. These decisions depend on the capabilities of each imaging facility, and they change periodically. Figure 2-13 shows the way a control chart might look. It is an example only and should not be used to establish control parameters in your imaging facility.

Before control charts are established, you must have a standard or starting point for each of the variables you intend to measure. These standards are derived by sensitometric or chemical tests over a given period of time or, in the case of color processing, are provided by the manufacturer. Generally speaking, when these tests are conducted within an imaging facility, they are to be performed by a PH with a background in photographic quality control (NEC 8126) or by a PH with extensive on-the-job training in QA. These specialists analyze the data collected over the test period, apply statistical formulas, and arrive at workable standards or means and upper- and lower-control limits. Therefore, in the rest of the discussion, assume that these standards have already been established. A word of caution, however, the chart, plot, and curve illustrations that

follow are presented as *examples only*. They should not be used as a basis for the QA program in any lab.

### **PLOTTING GAMMA OR CI ON A PROCESS-MONITORING CHART**

As explained previously, gamma and CI can be computed from the information plotted on a characteristic curve. Successive values are then plotted on control charts.

When gamma plots on a control chart beyond the control limits, several causes may be indicated, some of which include the following:

- The developer is being over- or under-replenished.
- The film was over- or underdeveloped.
- The processing temperature was too high or too low.

### **PLOTTING HIGH DENSITY ON A PROCESS CONTROL CHART**

A density step from a processed control strip is plotted as the high density (HD) on a control chart. The specific step number is determined in tests as discussed previously. Once this step has been determined, it should be used for each reading or plot until a new standard or mean is determined. For the purpose of our example, we are plotting or measuring step 16 as high density.

The following factors can cause the high density to be out of control:

- Variations in the processing temperature
- Variations in the processing time or machine speed
- Over- or underreplenishment

### **PLOTTING LOW DENSITY ON A PROCESS CONTROL CHART**

As with high density, low-density (LD) readings should also be taken from a predetermined density step of a control strip.

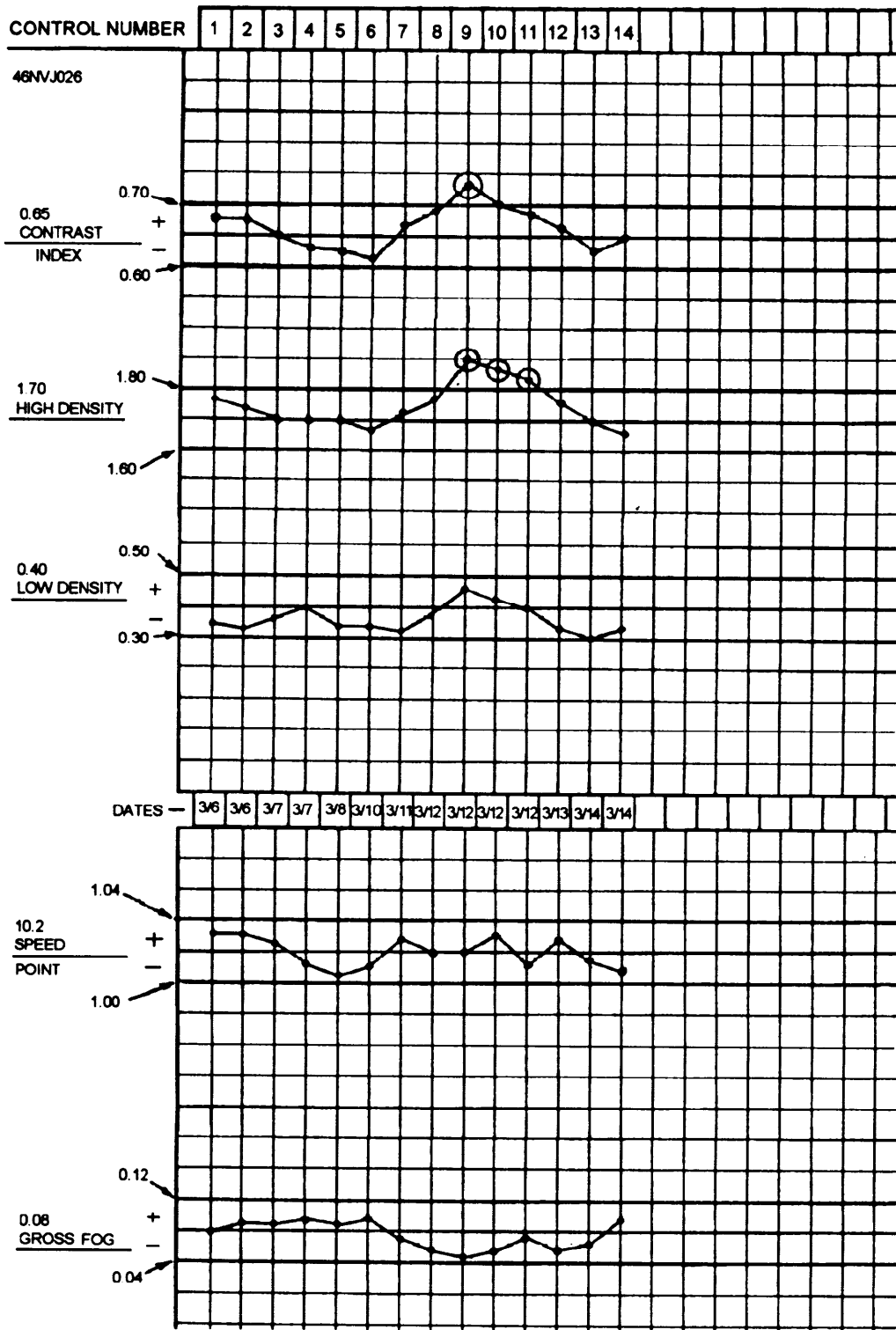

Figure 2-13.—Quality control chart.

The same factors that affect high density affect low density.

### **PLOTTING SPEED POINT ON A PROCESS CONTROL CHART**

The speed point (SP) is a measure of the effective film speed or exposure index of a film. The speed point is determined by sensitometric tests. The speed point is established using a step on a sensi-strip with a density of 0.10 above gross fog for ground pictorial film. The speed point of aerial film is established by using the step on a sensi-strip that has a density of 0.30 above gross fog.

Once the speed-point step is determined, that step is read in successive sensi-strips and plotted on the control chart. Neither effective film speed nor the ISO for ground pictorial film should be confused with effective aerial film speed because they are not equivalent.

### **PLOTTING GROSS FOG ON A PROCESS CONTROL CHART**

Gross fog (B+F) is read from a "clear" area of a control strip; that is, an area that does not receive exposure. All films have a gross fog density, resulting from several factors that may include the following:

- The density of the film base
- Chemical fog
- Age fog
- The development of unexposed silver halides
- Inadequate fixation (film not cleared)

As stated earlier, the amount of information you use to monitor or control your process depends on several factors. However, when you choose to monitor more than one processing variable, you should construct the appropriate control chart or use a piece of graph paper that can be posted near the process. Figure 2-14 shows a typical family of control charts for a process. A family of control charts, such as this, will provide you with a wealth of information about the process. Also, all the information is in one place.

## **LIMIT LINES**

The upper- and lower-limit lines on a control chart are based on the assumption that the plotted points are representative of a normal "population" or set of circumstances of the process. The limit lines, therefore, should include between them, all points representing an unchanged or normal process. Limit lines can never be placed in such a manner that all data are included between them; there will always be deviations. Samples from a black-and-white process, for example, show a gamma average of 0.70. On a subsequent test, a sensitometric strip was found to have a gamma of 0.80. Obviously this process appears to have changed or is changing. Should the process be altered? The answer must consider the factor of probability.

Two risks are involved in judging whether normal limits are exceeded. One risk occurs when a certain sampling appears outside one of the limit lines, indicating that the process is out of control, but the process is actually behaving normally and has not changed. This situation is known as the *alpha risk*. The reverse is also possible; it appears that the process is normal when actually it has changed or is changing. This is called a *beta risk*. These occurrences cannot be eliminated, but they can be reduced to the point where the probability of their happening is small. One risk is usually more costly than the other, and the limits are set accordingly. The limits are set far from the mean when the alpha risk must be avoided. They are set close to the mean when the beta risk must be avoided.

It is standard practice in black-and-white processing to place the limit lines at three times the standard deviation above and below the mean, or  $\pm 3s$ . The alpha risk is approximately 3 in 1,000 for limits of  $\pm 3s$ . Before proceeding, it is necessary to define the following two terms:

- Population—all possible results (happenings) in a certain process
- Variability—the amount of departure of measurements (parts of the population) from the mean (average)

Variability may be expressed in the following ways:

PROCESS CONTROL CHARTS

SENSITOMETRY

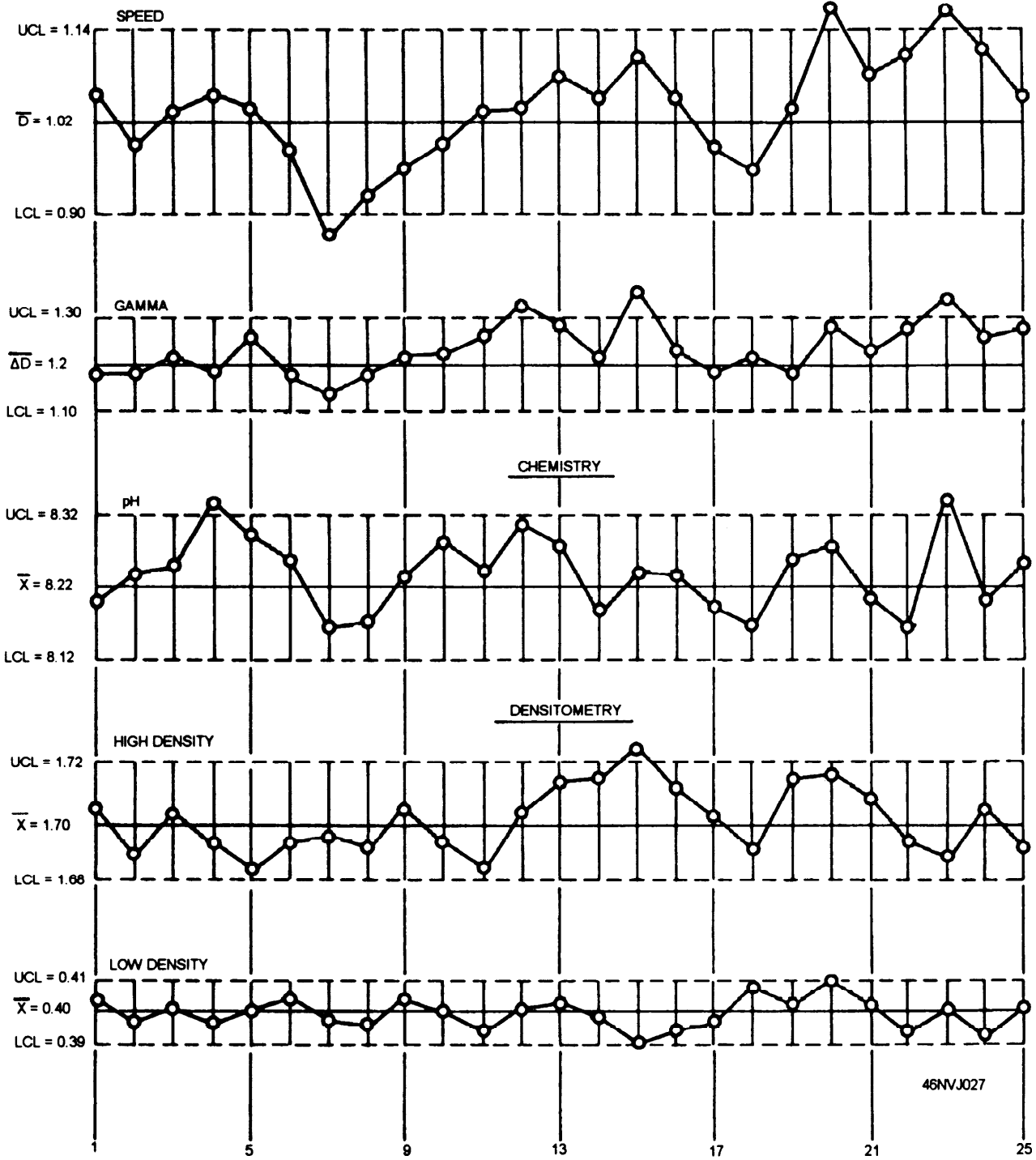

Figure 2-14.—Control chart examples.

- *Range*—the difference between the largest and smallest numbers of the set
- *Deviation*—the amount each element of the population is away from the mean
- *Standard error*—the average percent of deviation from the mean

## CONTROL CHART INTERPRETATION

Control charts for film processing should be maintained as long as the process is in operation. For control charts to be of value, you should remember the following guidelines:

- There must be a continuous analysis of a statistical nature of photo-processing control charts.
- It is pointless to maintain control charts, then fail to act when the chart indicates a problem in the process.
- Control charts let you visually determine a definite processing problem occurring among random process variations.
- There is always a certain amount of natural variability in a process.
- There can be overcontrol, as well as undercontrol, in precision quality assurance processing. Overcontrol of a process can be needlessly expensive.

These guidelines cannot be overemphasized and should become an integral part of your processing philosophy. Each process control chart you maintain can illustrate five possible conditions of that process. These conditions depend upon variations within that process. These five conditions are shown in figure 2-15.

A *normal pattern* exists in all processes that are operating correctly. This pattern reflects the variability that cannot be controlled or eliminated completely. When an *out-of-control* condition exists, immediate action should be taken to correct the problem. When the chart shows a *trend* in five successive recordings, this is a good indication that the process is changing and requires investigation with

possible corrective action. A *run* is when five successive recordings appear above or below the mean line. This also requires investigation and possible corrective action. A *jump* may indicate that a problem exists and requires correction before the process gets out of control.

## Evaluating Process-Monitoring Charts

To be useful, you must be accurate with a control chart and you must analyze it at least daily.

**PLOT PATTERNS.**—Plots, or points, on a control chart should be thought of as patterns or groups and not as individual points. It is not enough to know where a plot is; you must also know how it got there. In process monitoring, you must be able to recognize patterns that indicate when a process is moving toward an out-of-control condition. After a value is plotted on a chart, the point is connected to the previous point with a straight line. This provides a graphic representation of variations in the process and whether the desired processing conditions are being maintained.

**TRENDS.**—A drift of plotted points either upward or downward, away from the established mean, with no sudden change in direction is called a *trend pattern*. A trend usually consists of at least five plotted points. An upward or downward trend usually indicates over- or underdevelopment, respectively. The processed images will be either increasing or decreasing in both density and contrast. A trend that is gradual may be an indication of too much or too little replenishment.

**JUMPS.**—A plot point that jumps or suddenly moves away from previously plotted points may be caused by contamination of the chemistry, improperly mixed chemicals, or mechanical breakdowns, such as replenisher systems or thermostats. A jump pattern is likely to occur after a process has been shut down, especially if the process has not reached the proper operating temperature.

**RANDOM PATTERN.**—Whereas trends and jumps must be analyzed to determine their probable cause and corrective action taken when necessary, a random pattern within control limits indicates that the process is in control and is not moving toward an out-of-control condition. When an in-control random pattern is maintained, solution strength is probably normal and no correction is necessary; however, when

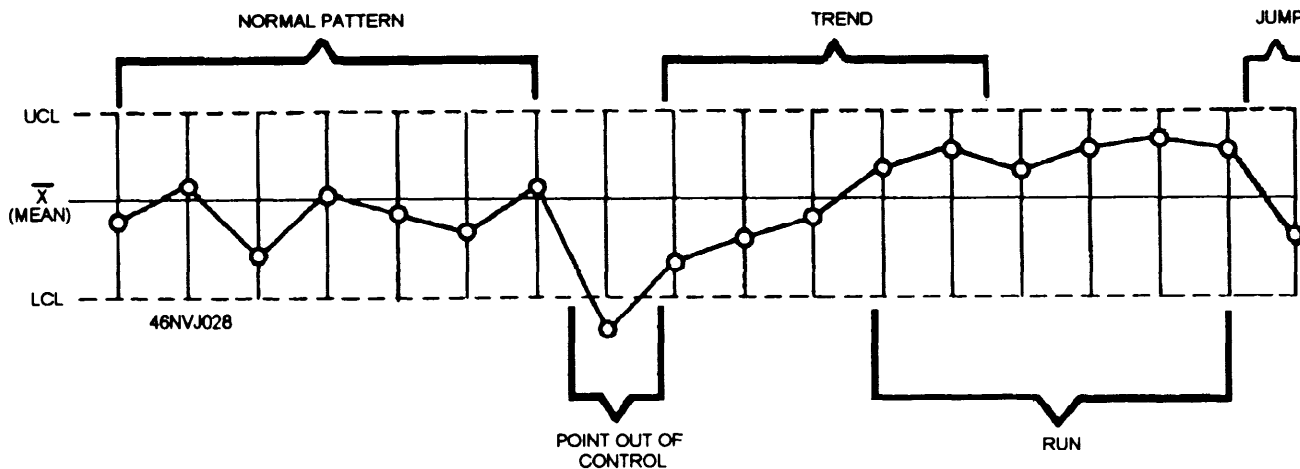

Figure 2-15.—Control chart interpretation.

a random pattern includes a run, the process may need corrective action.

### Correct Diagnosis

Sometimes two or more things may go wrong with a process at the same time and it is not clear which of several probable causes is resulting in trend, jump, or run patterns. In this case, each of the probable causes must be investigated until the cause(s) of the undesirable condition is/are found and eliminated. When there is more than one probable cause, you should start with the easiest one to correct, or the one that is most likely to occur.

When there is a sudden jump in the plot, look for factors that occur rapidly, such as changes in chemicals, temperatures machine speed, and so on.

When a plot falls outside of the upper- or lower-control limits, follow the steps given here, in the order of precedence, until you find the cause and correct it:

1. Check the appropriate instrument, such as the sensitometer, densitometer, pH meter, and hydrometer, to be sure it is calibrated and being used correctly.
2. Reread the sensi-strip or control strip densities or chemical sample to eliminate reading error as a cause of out-of-control plots.
3. Recheck the calculations and the plotting of values.

4. Ensure the processing temperature, agitation, and times are correct.

5. Review the chemical mixing and/or replenishment records to determine whether there is a discrepancy.

6. Prove or disprove the value of the questionable out-of-control plot by immediately running another control strip or taking another pH or specific gravity reading, as appropriate. This should eliminate the possibility of one improperly exposed, processed, or handled strip from indicating a problem in an otherwise normal process. When the values of this second reading are within limits, you can assume that the first or out-of-control value was the result of irregular or random conditions, and resume processing. On the other hand, when the second reading also gives an out-of-control value, stop processing production work until the problem has been found and corrected.

Monitoring black-and-white film processing is not difficult. A good-quality assurance program that relies heavily upon process monitoring can enable you to do the following:

- Detect problems before they become serious.
- Test processing solutions and evaluate their usefulness to determine when they need to be replaced.
- Maintain a continuous record of the process.

- Establish correct replenishment rates.
- Eliminate processing variables.

### **FILM PROCESS RECORDS**

One of the first steps in process monitoring is to keep accurate records. The process record should include every factor that may affect the process, including developer temperature, amount of film processed, amount of replenisher added, the person who processed the film or control strip, and the time of processing. By using a processing record form, you can establish and maintain proper replenishment rates and monitor the processing variables that affect processing quality. When control strips indicate that the process is, or is going, out of control, some potential causes can be eliminated by checking the processing record. This often makes it possible for you to determine the source of the problem. Also, when workers maintain processing records, they have an added incentive to follow prescribed processing procedures more carefully.

In any quality assurance program, it is always easier to prevent problems than to correct them after they occur. When you take the following steps, problems in processing can be reduced or eliminated:

- Store chemicals as recommended by the manufacturer.
- Observe effective working and shelf lives of chemicals. Remember, most chemicals change in photographic qualities due to age, both on the shelf before mixing and as working solutions.
- Make sure mixing, storage, and processing equipment is constructed of materials that are not affected by photographic chemicals or solutions.
- Use the purest water possible to prepare solutions and to wash materials.
- Filter water when necessary.
- Label all solution storage and processing tanks.
- Avoid solution contamination.

- Check the volumes of replenisher tanks and processing tanks.
- Check the accuracy of measuring instruments.
- Follow prescribed chemical-mixing procedures.
- Protect solutions with floating lids and/or dust covers.
- Use only proper film and processing techniques.
- Use recommended replenishment rates.
- Use recommended processing times.
- Use recommended processing temperatures.
- Use correct agitation.
- Use proper washing procedures.
- Dry film correctly.

When a control strip or sensi-strip is processed and evaluated at the end of the workday, or shift, you can take immediate steps to correct any problems to avoid delays at the beginning of the next work period.

### **COLOR PROCESS MONITORING**

Much of the material discussed previously about quality assurance is carried over to understand color quality assurance. However, color processing quality assurance is more critical than QA used for conventional black-and-white film, particularly because color balance must be considered.

As with black-and-white QA, color QA procedures begin with a series of controlled exposures, but on color film. These exposures are measured with a color densitometer and then the red, green, and blue densities are recorded on a graph. Control strips for color processing are produced by the manufacturer.

The materials used in color process monitoring are as follows:

- Monitoring manuals



- Control strips and reference strips
- Color densitometer
- Control charts
- Processing records of mechanical and chemical variables

## MONITORING MANUALS

Since the details of the monitoring procedure change with each color process, process-monitoring manuals, such as Kodak's Z-series, are necessary supplements to a color process-monitoring system. The monitoring manuals describe the process, the specific control strip to use, the steps to read, the calculation of reference values and control values, the specific plot patterns, and the plot-pattern interpretation.

## CONTROL STRIPS

Control strips for color process monitoring are supplied by the manufacturer of the color light-sensitive material or process. The most common control strips used in Navy imaging facilities are Kodak process-control strips. Like black-and-white control strips, color control strips have a series of neutral-density steps. Process monitoring relies primarily on the measurement of densities of the steps.

It is important to measure the minimum density and, usually, two steps representing intermediate tones. Monitoring D-max is also desirable for color reversal film and paper. The relationship among the three color measurements of a step is used to monitor color balance. The difference in the readings from the two steps (HD-LD) provides measurements of red, green, and blue contrast.

Control strips must be stored at 0°F (-18°C) or lower to minimize color shifts. The strips are stabilized and given an expiration date, so they provide a reliable tool to monitor processes. The strips should be removed from the freezer, one at a time, as they are needed.

A number of control strips from each control-strip batch are processed by the manufacturer. One of the processed strips is included with each package of control strips. These processed strips are called

*reference strips*. The reference strips provide a means for imaging facilities to determine a process standard in terms of densitometer readings.

By reading these reference strips and applying correction factors (supplied with the control strips) to specified steps, you can determine the initial reference, mean, or aim values.

## ESTABLISHING PROCESS-MONITORING PARAMETERS

The first time color process monitoring is used or the first time a process is started up, the steps for establishing a process-monitoring system are as follows:

1. Ensure that chemical and mechanical specifications are met. These include mixing procedures, processing temperatures, times, and so forth.

2. Determine initial reference values for the particular code of control strips you are using. This generally consists of reading the reference strip on the densitometer, recording the densities, and adding or subtracting correction factors (supplied with control strips). (See fig. 2-16.) When available, average the reading of several reference strips to minimize the effects of variability.

**NOTE:** Be sure that the reference strips and control strips you are using have the same code number. A code number is assigned to each emulsion batch, and this code number changes with each emulsion batch manufactured.

3. Process five control strips, one in different production runs. You should always feed the strip in a continuous processor with the low-density end first. The end of the film with the low-density steps is indicated with a dimple on the film. You should also feed the control strips into the processor at the same location of the feed tray. It does not matter whether you feed from the center, the far-right side, or the far-left side. It is important for you to process the control strips consistently to reduce variability.

4. Read the red, green, and blue densities of the specified control-strip density steps on the densitometer and average the values.

**KODAK EKTACOLOR RA Control Strips,  
Process RA-4**

**USE:** These control strips are used to monitor Process RA-4.  
**CAUTION:** Allow adequate warm-up time (10-15 minutes) at room temperature before removing enclosed reference strip from envelope.  
**AIM VALUES:** To obtain aim values for your process, apply the correction factors given below to the densities of the enclosed reference strip.

**CORRECTION FACTORS**

Developers	Code 2313	Status A Density		
		Red	Green	Blue
EKTACOLOR RA Developer Replenisher RT	Black	- .03	.00	.00
	High	- .03	.00	+ .01
EKTACOLOR RA Developer Replenisher	Low	- .02	+ .01	+ .01
	D-min	+ .01	.00	.00
EKTACOLOR RA 100 Developer Replenisher	Black	+ .03	+ .06	+ .06
	High	- .01	.00	+ .01
	Low	- .02	.00	.00
	D-min	+ .01	.00	.00

**Sensitogrammes KODAK EKTACOLOR RA de Contrôle  
du Traitement RA-4**

**UTILISATION:** Les sensitogrammes servent à contrôler le traitement RA-4.  
**ATTENTION:** Attendre le temps nécessaire (10-15 minutes) à température ambiante avant de le développer.  
**FACTEURS CORRECTIFS:** Pour déterminer les valeurs de référence, appliquer les facteurs correctifs, indiqués dans le tableau ci-dessous, à la densité du sensitogramme.

**KODAK EKTACOLOR  
RA Control Strips  
Process RA-4**

Reference Strip  
2313

46NVJ029

\* 説明です。  
 \* 10分程度に室温にて適切なウォームアップを行ってください。  
 \* 両対されたリファレンス・ストリップの密度を測定してください。

  
 Made in U.S.A. by  
**EASTMAN KODAK COMPANY**  
 Rochester, N.Y. 14650  
 104-02C Printed in U.S.A. The Kodak, Ektacolor

Figure 2-16.—Correction factors supplied with control strips.

5. Subtract the initial reference values from the averaged, processed control-strip density values. When a control parameter of high density minus low density is specified for the process, determine that also. The results of these subtractions are known as the *aim values*. The example in figure 2-17 summarizes steps 1 through 5 to show you how the aim- or center-line values are derived for an LD step.

In the example below, LD red plots four lines below the center line, LD green plots one line above the center line, and LD blue plots one line below the center line.

6. Adjustment tolerances may be applied to the aim values, as appropriate, to bring the control-strip values closer to the aim values. These adjustment tolerances are specified in each process-monitoring manual. For example, the red low-density (LD) value for your processed control strip is 0.28. The adjusted reference value is 0.32. The process-monitoring manual indicates that the aim-value adjustment tolerance for LD is  $\pm 0.04$ . You can adjust the red center-line value by subtracting 0.04 from the adjusted reference values ( $0.32 - 0.04 = 0.28$ ). The adjusted

aim value of 0.28 is your new center line or aim value on your control chart.

**NOTE:** The adjustment tolerances change for each step and each type of process. You must consult the appropriate process-monitoring manual to obtain these tolerances.

7. Tolerance limits are defined and prescribed in each process-monitoring manual. When the average control values obtained in the preceding step fall within the tolerance limits, production work may be processed and the initial reference values may be used to determine future control values for that particular code of control strips.

8. When average control values fall outside tolerance limits, it is likely that there is a mistake in the following: reading the control strips, performing the calculations, setting up the densitometer, or starting up the process. If errors are not detected, there may be something wrong with the control strip. Improper storage or handling may be the problem. If possible, start over and use a new batch of control strips.

	<u>Red</u>	<u>Green</u>	<u>Blue</u>
Initial reference strip readings of LD (averaged)	0.31	0.52	0.70
Correction factors of LD	+0.01	-0.01	0.00
Adjusted reference values	0.32	0.51	0.70
LD readings of five processed control strips (averaged)	0.28	0.21	0.69
Adjusted reference values minus processed control-strip values	+0.04	+0.01	-0.01

Figure 2-17.—Deriving LD aim values for a process-monitoring chart.

9. When the source of the out-of-control condition is found and corrected, repeat procedures in steps 1 through 6.

## LIMITS AND TOLERANCES

Once the mean or standard has been established, *action* and *control limits* are set according to the appropriate monitoring manual. The action limits act as "early warning" limits. Production work can still be processed when the action limit is exceeded, but this indicates that a condition exists that needs to be corrected or the process may drift out of control. Once the process drifts out of control, you should stop production until the problem is corrected. If a control strip shows that the control limits have been exceeded, confirm this with a second strip; then refer to the appropriate monitoring manual and stop production until the trouble is corrected.

As you continue to plot control values, you will see a random variation around the process mean over which you have little control. As long as the control limits are not exceeded, acceptable quality can be expected.

## COLOR PROCESS CONTROL CHARTS

A good control program uses control charts and subjective print quality analysis in decision making. A control chart provides a tool to avoid situations where a serious processing error is compensated for in printing to keep print quality acceptable. An imaging facility that is compensating for errors near or beyond the control limits is certain to have more quality problems than a facility operating within acceptable standards.

Preparing a control chart, such as the Kodak Color Process Record Form, No. Y-55, is quite easy. Follow this 8-step procedure:

1. Use a separate chart for each processing machine.
2. Record the reference strip code number and the reference values in the appropriate places. Use color pencils to distinguish the red, green, and blue densities when recording the reference values.
3. Draw horizontal lines to represent the mean, action limits, and upper- and lower-control limits.

4. Record the process and machine number.

5. When plotting the control values, record the date and time that the control strip was processed (not read), and note any chemical or mechanical changes made as a result of the plots.

6. Plot control values having a plus sign above the line that represents the reference value, and plot control values with a minus sign below the reference value line.

7. Connect the points to provide a continuous graph.

8. When changing to a new control strip code number, note it on the chart. Record the date and the new reference values and limits.

The control charts shown in figure 2-18 are not intended to represent an actual control film or process. It is used for illustration purposes only to show patterns that can occur on actual control charts.

## Processing Control Strips

Once control charts are established, control strips must be processed on a regular basis. Each color product has a particular control strip with a particular format. In a sink-line process, a control strip should be processed with each run of production film because of human variables. In continuous (machine) processors, control strips should be processed as follows:

- Before processing production work at the beginning of the workday, or shift, or after a long shutdown, such as a weekend.
- Along with production work, at various times throughout the day.
- At the end of each workday, or shift.
- After any chemical or mechanical change. Be sure to indicate this change on the control chart.
- Whenever fresh chemicals are used in the process. Make a note of this on the control chart.

# How Control Strip Densities Become Control Plots

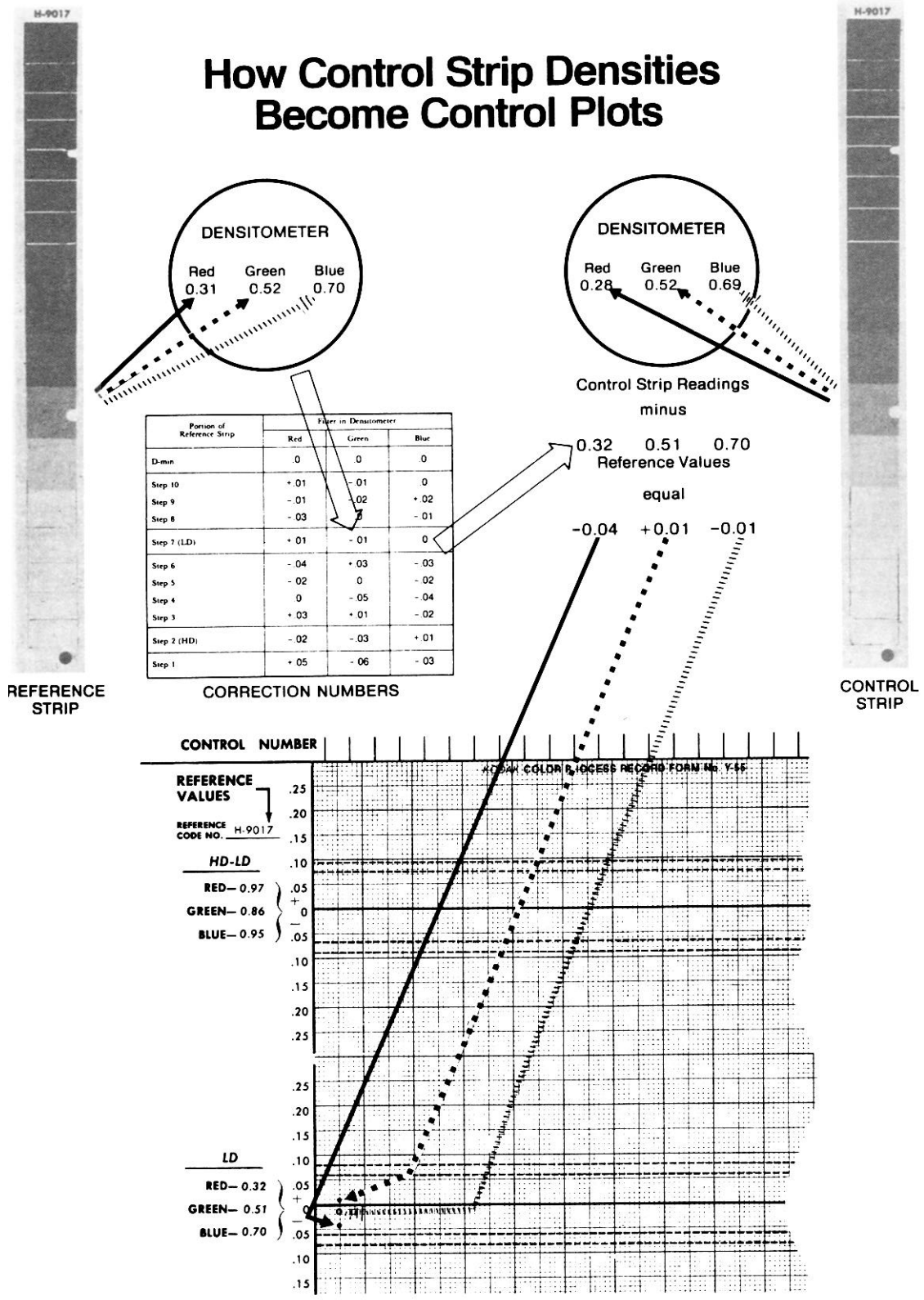

Figure 2-18.—Record Form Y-55.

- Whenever a problem is suspected.

As soon as a control strip comes out of the dryer, identify it with the time and date of processing (not the time it was actually read). A code number identifying a machine or operator is also helpful when your facility has more than one of the same type of processor.

Always inspect a control strip for physical or chemical defects before reading the appropriate densities. Use the middle area of the density steps for taking the density readings. Make each measurement twice. You should use a slightly different area of the step each time, and average the readings.

The emphasis in process monitoring is on densitometry. Keep in mind, however, that changes in the process are made by chemical and mechanical variations, intentional or not. Problems are much easier to track when records are kept of all intentional changes in the following:

- Machine speed
- Solution temperatures
- Replenishment rates
- Agitation
- Filters
- Squeegee adjustments
- Parts (racks, gears, pumps, and lines)
- Operators
- Processing solutions
- Types of film



**Figure 2-19.—A Navy Photographer's Mate inspects prints for physical defects that are exiting a processor.**

*Photo by PH2 Sharon Nelms-Thorsvik*

- Control strips

### **Action to Take When Control Limits Are Exceeded**

When you are interpreting control value plots, your first consideration should be to determine whether a plot has exceeded the action limits or control limits. As long as the plots fluctuate within action limits, the process is running in control and generally should be left alone. If a red, green, or blue measurement exceeds the action or control limits, verify the readings, check the process, and immediately process another control strip. When the results confirm those of the first strip, proceed as follows.

An out-of-control situation is serious; therefore, it is important that the information indicating such a condition is correct. When the out-of-control condition is verified by a second control strip, it must be considered real. Two consecutive control strips seldom provide similar false information about a process.

Processing trends and tendencies are not as well defined as control values, but they are equally important. These conditions in the process indicate unnecessary bias or drift away from the mean. For example, when successive plots of control values show that an increasing number of densities are

moving away from the mean in a particular direction, you must take corrective action to stop or reverse the trend before plots have moved beyond the control limit. Also, processing conditions that cause control values to plot consistently within but near a control limit are acceptable.

Each of Kodak's Z-series manuals has a section devoted to possible causes of processing problems and visual references of how they appear on a control chart. Diagnostic charts are also provided to give possible causes that can affect the process and what action to take in each instance. Each specific monitoring manual includes verbal descriptions of problems and lists possible solutions.

## **PHYSICAL QUALITY**

The quality assurance and monitoring methods in this chapter discussed sensitometric aspects because they are quite complex. Physical quality, however, is equally important. It is good practice to monitor physical quality along with image quality by a methodical examination of control strips and finished work. The appearance of scratches, digs, spots, or streaks indicates a mechanical malfunction somewhere in the processing cycle (fig. 2-19). In many cases, the causes of these defects are self-evident, and often a bypass test can isolate the malfunction.

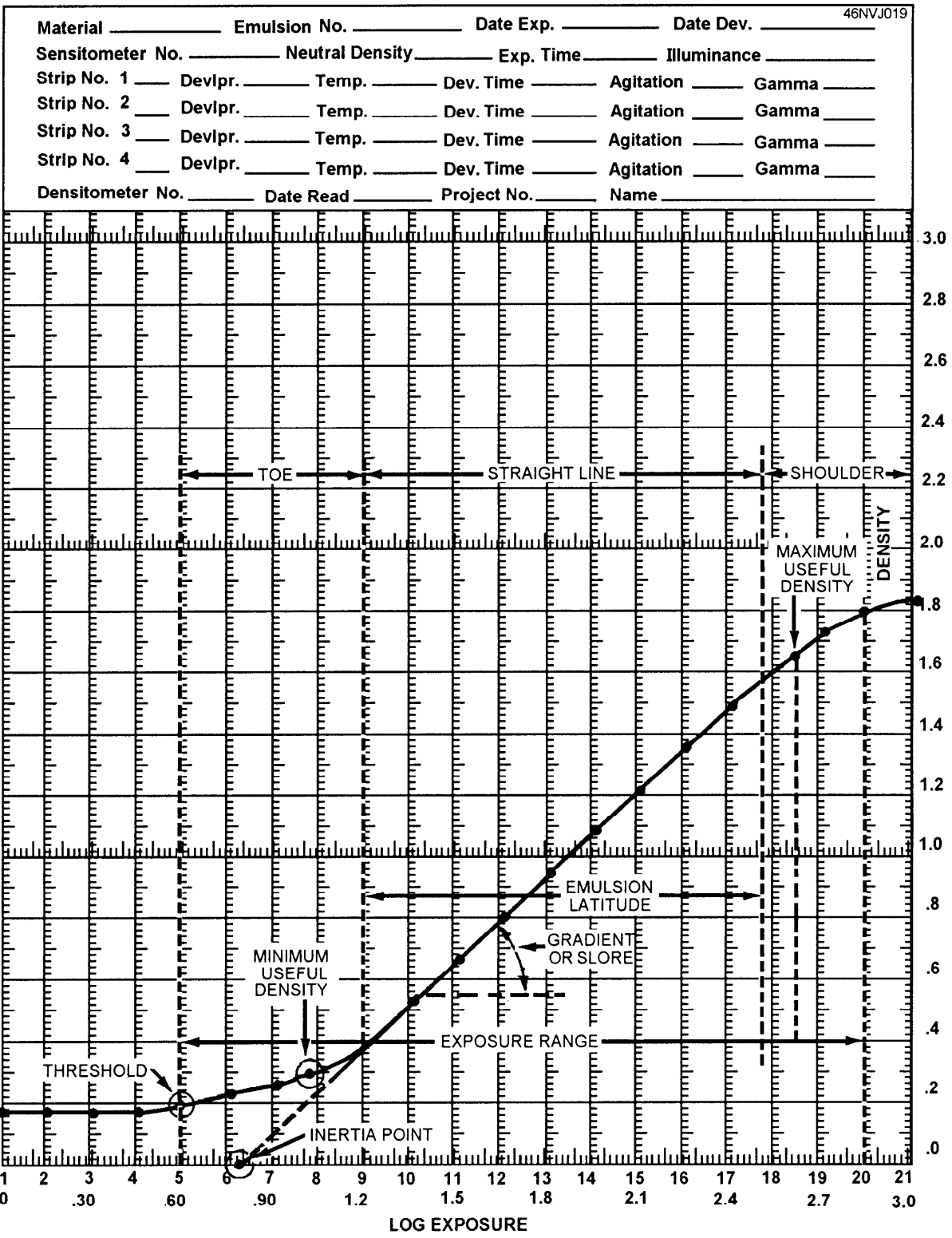

Figure 2-6.—Information derived from a characteristic curve.



## CHAPTER 3

# ELECTRONIC IMAGING

With the evolution of electronic imaging, the technology involved today in the creation, manipulation, and distribution of images allows photographers to perform functions that they only dreamed of a decade ago. Procedures that once took hours or even days in the conventional darkroom can now be accomplished within minutes under normal room lights and without getting your hands wet. With the electronic medium, images may be created, modified, and enhanced. The end product is limited only by your imagination. Several distinct advantages of electronic imaging as compared to conventional photography are in use today. These advantages are as follows:

- It saves the time required in conventional development and printing.
- It saves money by eliminating direct and indirect costs related to developing and printing photographs.
- It is environmentally friendly.
- It can be viewed immediately.
- Images can be transmitted instantly and rapidly using standard telephone lines.

Electronic imaging used in the Navy today ranges from capturing and processing an image through an electronic medium to conventional silver-halide technology and electronic processing by way of a hybrid system. Because of the dynamic advances in this growing field, this chapter is intended only as a brief overview of the basic principles and applications of electronic imaging. To be prepared for this fascinating technology, you must become familiar with computer systems, electronic imaging, and the equipment used to create digital images.

### BASIC COMPUTER FUNDAMENTALS

Computers are often compared to people since both have the ability to accept information, work with it, store it, retrieve it, and provide information output. The

primary difference is that people have the ability to perform all of these actions independently without outside assistance. People also think and control their own actions. The computer, however, requires a program (a predefined set of instructions) to accomplish an assigned task. People receive information in several different forms, such as eyes, ears, nose, mouth, and even sensory nerves. Our brain receives and accepts this information, works with it in some manner, and then stores it somewhere in the back of our mind (memory) for future use. If information at the time requires immediate attention, our mind directs us to respond with words or actions. Likewise, the brain of a computer is the central processing unit (CPU). The CPU is designed to do basically the same thing; that is, it receives information (input data), works with this information (processes data), and transmits this information (output data) to some form of output media.



46NVJ032

Computers are incapable of independent thought or action; they can do nothing more than perform the instructions given to them. Computers simply follow a set of instructions stored internally (called a program) and process the input data. Then when all the steps are followed properly, the computer provides an end result that you can work with.

The computers used in electronic imaging are general-purpose digital computers. These general-purpose computers are capable of performing operations, such as word processing, graphic applications, and spread sheet because they can store a wide variety of programs in internal storage.

### COMPONENTS OF A DIGITAL COMPUTER

Components, or tools, of a computer system are grouped into two categories: **HARDWARE** and **SOFTWARE**. Hardware consists of the machines that comprise a computer system, such as all the mechanical,

electrical, electronic, and magnetic devices within the computer itself and all related PERIPHERAL devices. The peripheral devices consist of items, such as a keyboard, magnetic tape unit, mouse, scanner, printer, and so on. The software items are programs and operating aids written so the computer can process data. The manufacturer supplies much of the initial software for a particular computer. This software is known as SYSTEMS SOFTWARE. Systems software is designed for broad general use. Examples of systems software are DOS (disk operating system) for IBM compatible computers and System 7 for Apple computers. Software designed to meet a specific requirement or purpose is called APPLICATION SOFTWARE. Examples of application software are *WordPerfect*, *Lotus 1-2-3*, and *Adobe Photoshop*.

## FUNCTIONAL UNITS OF A COMPUTER SYSTEM

Digital computer systems consist of three distinct units. These units are as follows:

- Input unit
- Central Processing unit
- Output unit

These units are interconnected by electrical cables to permit communication between them. This allows the computer to function as a system.

### Input Unit

A computer must receive both data and program statements to function properly and be able to solve problems. The method of feeding data and programs to a computer is accomplished by an input device. Computer input devices read data from a source, such as magnetic disks, and translate that data into electronic impulses for transfer into the CPU. Some typical input devices are a keyboard, a mouse, or a scanner.

### Central Processing Unit

The brain of a computer system is the central processing unit (CPU). The CPU processes data transferred to it from one of the various input devices. It then transfers either an intermediate or final result of the CPU to one or more output devices. A central control section and work areas are required to perform calculations or manipulate data. The CPU is the

computing center of the system. It consists of a control section, an arithmetic-logic section (fig. 3-1), and an internal storage section (main memory). Each section within the CPU serves a specific function and has a particular relationship with the other sections within the CPU.

**CONTROL SECTION.**—The control section directs the flow of traffic (operations) and data. It also maintains order within the computer. The flow of control is indicated by dotted arrows in figure 3-1. The control section selects one program statement at a time from the program storage area, interprets the statement, and sends the appropriate electronic impulses to the arithmetic-logic and storage sections so they can carry out the instructions. The control section does not perform actual processing operations on the data. The control section instructs the input device on when to start and stop transferring data to the input storage area. It also tells the output device when to start and stop receiving data from the output storage area.

**ARITHMETIC-LOGIC SECTION.**—The arithmetic-logic section performs arithmetic operations, such as addition, subtraction, multiplication, and division. Through internal logic capability, it tests various conditions encountered during processing and takes action based on the result. As indicated by the solid arrows in figure 3-1, data flows between the arithmetic-logic section and the internal storage section during processing. Specifically, data is transferred as needed from the storage section to the arithmetic-logic section, processed, and returned to internal storage. At no time does processing take place in the storage section. Data maybe transferred back and forth between these two sections several times before processing is completed. The results are then transferred from internal storage to an output device, as indicated by the solid arrow in figure 3-1.

**INTERNAL STORAGE SECTION.**—The internal storage section is sometimes called primary storage, main storage, or main memory, because this section functions similar to our own human memory.

The storage section serves four purposes; three relate to retention (holding) of data during processing. First, as indicated by the solid arrow (fig. 3-1), data is transferred from an input device to the INPUT STORAGE AREA where it remains until the computer is ready to process it. Second, a WORKING STORAGE AREA ("scratch pad" memory) within the storage section holds both the data being processed and the intermediate results of the arithmetic-logic operations. Third, the storage section retains the

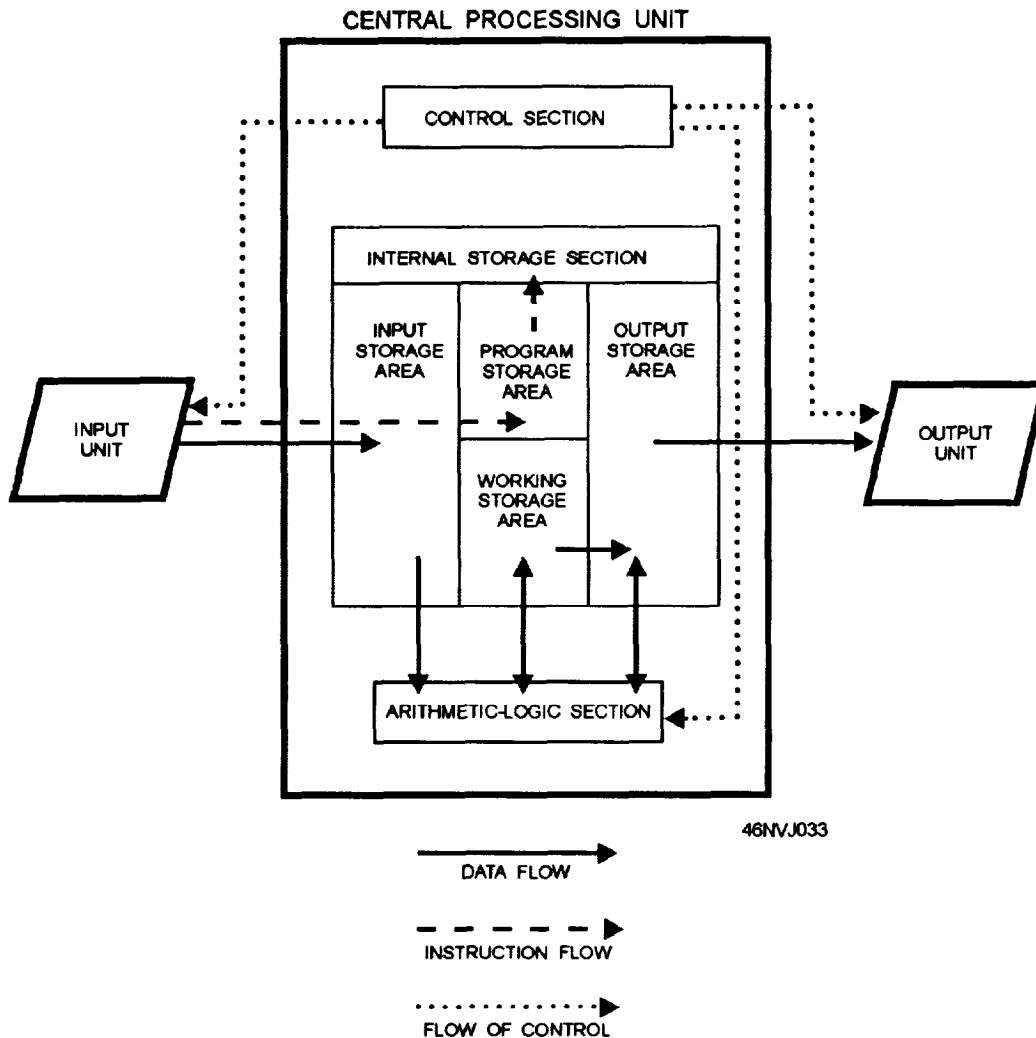

Figure 3-1.—Sections of a CPU.

processing results in the OUTPUT STORAGE AREA. From there the processing results can be transferred to an output device. The fourth storage section, the PROGRAM STORAGE AREA, contains the program statements transferred from an input device to process the data. Please note that the four areas (input, working storage, output, and program storage) are NOT fixed in size or location but are determined by individual program requirements.

### Output Unit

As program statements and data are received by the CPU from an input device, the results of the processed data are sent from the CPU to an OUTPUT DEVICE. These results are transferred from the output storage area onto an output medium, such as a floppy disk, hard drive, video display, printer, and so on.

By now, you should have an idea of the functions performed by a CPU. It is the CPU that executes stored programs and does all of the processing and manipulating of data. The input and output (I/O) devices simply aid the computer by sending and receiving data and programs.

### COMPUTER SYSTEM HARDWARE

Computer system hardware includes the CPU and its associated input and output devices. Input and output devices, separate from the CPU itself, are called peripheral equipment. The CPU communicates with each peripheral device through input and output channels. To operate an electronic-imaging workstation, you must have a general understanding of CPU primary and secondary storage, peripheral devices, input and output channels, and modems.

## **CPU PRIMARY AND SECONDARY STORAGE**

The CPU contains circuits that control and execute instructions by using some type of MEMORY. Memory is referred to by size, such as 16K, 32K, 64K, and so on. The "K" represents the value of 1,000. Therefore 16,000 is 16K.

Semiconductor memory consists of hundreds of thousands of tiny electronic circuits etched on a silicon chip. Each of these electronic circuits is called a BIT CELL and can be in either an OFF or ON state to represent a 0 or 1 bit. This state depends on whether or not current is flowing in that cell. Another name used for semiconductor memory chips is integrated circuits (ICs). Developments in technology have led to large-scale integration (LSI) that allows more and more circuits to be squeezed onto the same silicon chip.

Some of the advantages of semiconductor storage are fast internal processing speeds, high reliability, low power consumption, high density (many circuits), and low cost. However, there is a drawback to this type of storage. It may be VOLATILE, which means it requires a constant power source. When the power for your system fails and you have no backup power supply, all of the stored data is lost.

### **Primary Storage**

Two classifications of primary storage with which you should become familiar are read-only memory (ROM) and random-access memory (RAM).

**READ-ONLY MEMORY (ROM).**—In computers, it is useful to have instructions that are used often, permanently stored inside the computer. ROM enables us to do this without losing the programs and data when the computer is powered down. Only the computer manufacturer can provide these programs in ROM; once done, you cannot change it. Consequently, you cannot put any of your own data or programs in ROM. Many complex functions, such as translators for high-level languages, and operating systems are placed in ROM memory.

Since these instructions are hardwired, they can be performed quickly and accurately. Another advantage of ROM is that your imaging facility can order programs tailored for its specific needs and have them installed permanently in ROM. Such programs are called microprograms or firmware.

**RANDOM-ACCESS MEMORY (RAM).**—RAM is another type of memory found inside computers. It

may be compared to a chalkboard on which you can scribble down notes, read them, and erase them when finished. In the computer, RAM is the working memory. Data can be read (retrieved) or written (stored) in RAM by providing the computer with an address location where the data is stored or where you want it to be stored. When the data is no longer required, you may simply write over it. Thus you can use the storage location again for something else.

### **Secondary Storage**

Secondary storage, or auxiliary storage, is memory external to the main body of the computer (CPU) where programs and data can be stored for future use. When the computer is ready to use these programs, the data is read into primary storage. Secondary storage media extends the storage capabilities of the computer system. Secondary storage is required for two reasons. First, the working memory of the CPU is limited in size and cannot always hold the amount of data required. Second, data and programs in secondary programs do not disappear when the power is turned off. Secondary storage is nonvolatile memory. This information is lost only when you erase it. Magnetic disks are the most common type of secondary storage. They may be either floppy disks or hard disks (hard drives).

## **PERIPHERAL DEVICES**

Peripheral devices include all the input and output devices used with a computer system. When these devices are under control of the CPU, they are said to be on line. When they perform their function independently, not under direct control of the CPU, they are said to be off line. The following peripheral devices are used commonly for input and output. Those that perform only input are marked (I), those that perform only output are marked (O), and those that perform both input and output are marked (I/O).

### **Optical Character Reader (I)**

An optical character reader reads printed data (characters) and translates it to machine code.

### **Keyboard (I)**

The keyboard is used by a computer operator to communicate with a computer system.

## **Mouse (I)**

A small hand-held device used by a computer operator for positioning the cursor, making freehand sketches, or selecting items from menus on a screen. When the mouse is rolled across the surface of the desk, the cursor moves a corresponding distance on the screen.

## **Scanner (I)**

A means of converting hand-drawn art or photographs into digital form.

## **CD-ROM Drive (I)**

CD-ROM (compact disk-read only memory) technology is similar to audio disks, except it includes routines for detection and correction of data errors. A CD-ROM drive may be internally or externally installed. It holds a vast amount of information that makes it valuable to store digital images. Once recorded, information on CD-ROM cannot be erased or changed, but it can be read many times. The expression *Write Once, Read Many* (WORM) describes this type of technology.

## **Magnetic-Tape Unit (I/O)**

The magnetic-tape unit moves magnetic tape across read-write heads that actually read and write the information. Data is recorded sequentially in the form of magnetic spots along the entire length of the tape.

## **Magnetic-Disk Drive Unit (I/O)**

The magnetic disk drive unit is a storage device that reads and writes information on the magnetized surfaces of rotating disks. The disks are made of thin metal, coated on each side so data can be recorded in the form of magnetized spots. As the disks spin around like a music record, characters can be stored on them or retrieved from them in a random (direct) manner. Accessing data directly has several advantages over accessing data stored sequentially. It provides fast immediate access to specific data. You can direct the disk drive to read at any point. Magnetic disk drives come in two types: hard drives and floppy drives. Magnetic disk drives are in computer systems and electronic cameras. Floppy disks come in several sizes, ranging from 3 to 8 inches in diameter; the 3 1/2-inch diskette is most common.

## **Optical Disk Drive (I/O)**

A drive used with a form of data storage in which a laser records data on a disk that can be read with a lower-power laser pickup. Three types of optical disks are used: Read Only (RO), Write Once, Read Many (WORM), and erasable. Two types of erasable disks are used: Thermo Magneto Optical (TMO) and Phase Change (PC).

## **Printer (O)**

The printer is a widely used output device that expresses characters, graphics, drawings, or photographs on hardcopy (paper or film). A large range of printers is available. Printers are discussed in more detail later in this chapter.

## **Monitor (O)**

The monitor is similar to a television screen. It allows you to see the program or data.

## **INPUT/OUTPUT CHANNELS**

Input/output (I/O) channels provide a means of communication between the CPU and peripheral devices. This is accomplished by electrical cables that carry both data and control information between the computer and the peripheral devices.

Signals are transmitted and received through a cable that connects the CPU to an on-line device. This cable provides a path (channel) for the signal to travel. Signals for both monitoring and data are transmitted by way of I/O channels. These I/O channels may be used specifically for data input, data output, or data input and output. On desktop computers, the I/O channels are referred to as communication ports.

### **Types of Channels**

Channels, both input and output, may be either simplex or duplex. A simplex channel is only capable of communication in one direction. When a peripheral device, such as a mouse, is connected to a simplex circuit, it is only capable of transmitting data. Simplex circuits are seldom used because a return path is generally required for acknowledgment, control information, or error message.

Duplex channels provide two paths for the transmission of data. One path is for sending, and one is for receiving data.

## Data Transmission Methods

Data may be transmitted over a channel in one of two ways, either in the serial or the parallel mode.

**SERIAL MODE.**—In serial mode (transmission), three wires are required: one to transmit data, one to receive data, and one for a ground. The data is sent or received in the form of bits, one after another in a series, as shown in figure 3-2. This type of transmission is desirable whenever a computer system is linked to outside peripherals over a long distance, such as remote terminals.

**PARALLEL MODE.**—In parallel mode (transmission), the data bits are all sent or received simultaneously. Parallel transmission requires nine or ten wires to connect the computer to the peripheral device (fig. 3-2). Seven or eight lines are required for data bits, one or two lines for “handshake” purposes, and one line for a ground. The handshaking signals communicate information back and forth between the peripheral devices and the computer. This information lets the peripheral know when the computer is ready to accept another character and vice versa. This type of transmission is useful for fast data transfer. The principal drawback is the computer must not be located relatively close to the peripheral device.

## MODEMS

When data is transmitted directly to the computer over long distances, it is necessary to add two other devices, one at each end. These devices are called modems. The word *modem* is an acronym for **MO**dulator-**DE**Modulator. A modem converts the digital signal produced by a computer to a suitable audio signal for transmission over communication lines (I/O

channels). The modem at the other end of the line reconverts the audio signal back to a digital signal before sending it to the CPU. If this conversion (digital to audio) was not carried out, the digital signal would degenerate during transmission and become garbled. Modems are commonly used to send and receive data over telephone lines, making them a very valuable tool for imaging facilities.

## COMPUTER SYSTEM SOFTWARE

Software plays an important role in computer operations. Without software, a computer could not perform simple addition. It is the software that makes everything happen. "Software" may be defined as all the stored programs and routines (operating aids) required to use the capabilities of a computer system fully. Basically, two types of software are used: systems software and applications software.

## SYSTEMS SOFTWARE

Systems software is often referred to as systems programs. Systems software consists of supervisory and support programs designed to coordinate the capabilities of the computer itself. These include programs, such as operating systems, assemblers and compilers, and utilities.

## Operating Systems

An operating system is a collection of many programs used by the computer to manage resources and operations. These programs control the execution of other programs. They schedule, assign resources, monitor, and control the work of the computer. These actions are carried out without human intervention.

## Assemblers and Compilers

Both assemblers and compilers are language translators. They are designed for specific machines and specific languages. They translate computer programs written in programming language into machine language. A language translator for an assembly language is called an assembler program. Most high-level language translators are compiler programs. These translators are designed to convert artificial languages used by programmers into machine-usable code after it is entered into the computer.

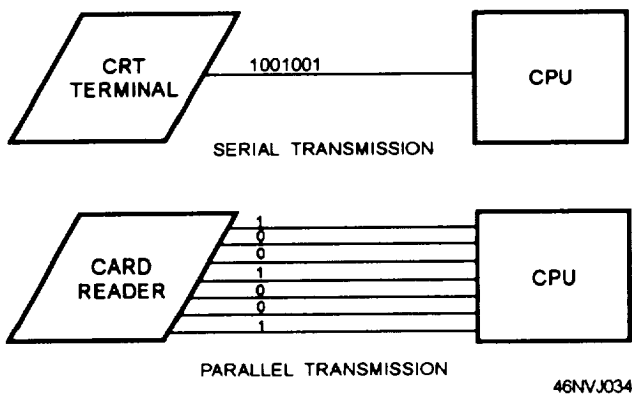

Figure 3-2.—Serial and parallel data transmission.

## Utility Programs

Utility programs perform tasks, such as sorting, merging, and transferring data, from one I/O device to another. They may be separate programs, or they may be included in an operating system to help the user perform these tasks. Text editors may also be included in an operating system so the user can enter, add, delete, or change program statements; debug routines may also be included to help the user locate errors.

## APPLICATIONS SOFTWARE

Applications are those particular programs designed to solve individual user problems. These programs can be written by you, the user of a computer system, developed by a central design agency, or they can be purchased from a software firm. Numerous types of applications programs are written. They range from games to word processing and electronic imaging.

## ELECTRONIC IMAGE

When discussing electronic images, you must become familiar with the term *pixel*. The word *pixel* means picture element. A pixel is the smallest picture element that a peripheral device can display on screen. It is these individual elements that construct the image. The quality of an electronic image is determined by the pixels of the image—the more pixels per image, the greater the quality of the photograph.

A pixel is not an absolute unit, such as a millimeter. A pixel depends on other factors to determine its resolution. The image resolution depends on the number of pixels in a specific area. For example, a 1/2-inch square area containing 270,000 pixels has better resolution than a 1-inch area having the same number of pixels. However, resolution is not based solely on the number of pixels.

The resolution of electronic images depends on the size and the total number of individual pixels used to depict a single image. Each pixel can contain only one color or shade of gray. The smaller the pixels (more pixels per image), the closer the image can be viewed before the individual pixels are seen. Likewise, larger pixels may be objectionable. By increasing the number of pixels, you obtain finer detail.

When thinking in terms of resolution, you cannot compare pixels to the grain in film. Film resolution is not directly comparable to electronic-imaging resolution. Additionally, different types of imaging

hardware use different types of measurements. For example, some equipment describes resolution in pixels and other equipment describes resolution in dots per inch (dpi). Pixels and dpi are not directly related or interchangeable.

Another problem in terms of resolution is there are no established conversion standards for images captured on different forms. An example where nonstandardization may present a problem is when comparing images from an analog camera to the products from a digital camera or the image output from an electronic printer or a film recorder.

## ELECTRONIC-IMAGING WORKSTATION

Electronic imaging involves more than simply taking a photograph with an electronic camera. Like conventional photography, exposing the film is not enough. After the image is captured on film, it must be processed before the image can be viewed as a positive transparency or as a negative image that must later be printed to provide a useable positive image.

Images that are generated electronically must also be processed, but the methods to make the image visible and useable are completely different. On an electronic-imaging workstation, your "darkroom" is a computer system. To operate an electronic-imaging workstation, you must have both hardware and software. There are basically five components in an electronic-imaging system; they are the following: some type of input, a computer platform and software, display, storage, and hardcopy output (fig. 3-3).

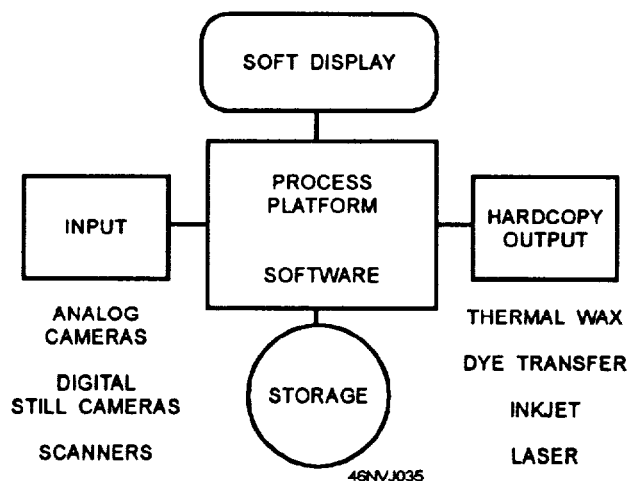

Figure 3-3.—Five basic components to an electronic-imaging system.

One major problem you will encounter when setting up an electronic-imaging station is interconnecting the various components that make up the imaging system. The technology in each component area is developing at a rapid rate. With the ever-increasing number of hardware components and software packages available on the market, setting up the links between the devices can become frustrating. Before choosing new components for a system, you must look carefully at each piece of new equipment to be sure it is compatible with the existing system.

## INPUT

Several ways to acquire photographs electronically are used. You can obtain these photographs from digital or still-video cameras, or you can scan and digitize existing film and paper images.

Before a computer with the appropriate software can be used to modify or enhance an image, the image must be converted to digital values. Images that are imported from a still-video camera are in analog waveform. An analog waveform is a value that varies continuously over time (fig. 3-4). For an analog waveform to become a digital signal, both the value and the time must be changed into noncontinuous, numeric values of ones and zeros (fig. 3-5). The process used to determine time is called sampling. Sampling is done at equal increments of time. Conversion of continuous values into distinct values is called QUANTITIZING. The combined process is called analog-to-digital conversion (A/D conversion) or DIGITIZING.

The A/D conversion process is an approximation. When the sampling rate is low, a very inaccurate representation of the signal results. When the sampling rate is high, virtually an exact copy of the original signal is attained. When color images are digitized, the red, green, and blue information is handled as three separate sets of data to produce three sets of digital information.

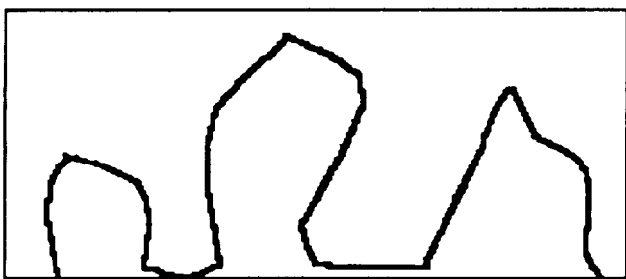

46NVJ036

Figure 3-4.—Analog waveform.

0	1	1	0
1	0	0	1
1	1	0	0

46NVJ037

Figure 3-5.—Digital signal.

In this case, three A/D circuits are used and the encoding is done simultaneously.

When an image is digitized, a series of points are created. These points are called pixels. When the resolution of the display system is low, the individual pixels may be noticeable. This objectionable resolution is called pixelation.

## Electronic Still Cameras

The advantage of using a digital or still-video camera is the image may be captured and input to the electronic-imaging workstation instantly. The features on these cameras are basically the same, and they are used in the same manner as conventional cameras. The features of conventional cameras and electronic cameras that are similar are as follows:

- The lenses may be fixed or interchangeable, depending on the camera.
- The lenses are identified by f/stops and focal length.
- The focusing may be fixed, automatic, or manual, depending on the camera.
- The range of shutter speeds is similar.
- The flash may be built-in or have a dedicated hot shoe.

Each electronic camera has an image sensor. The image sensor, called the “charge-coupled device” (CCD), is the main component of an electronic camera. The CCD is rated in size, pixels, and ISO. The larger the CCD, the more pixels it can record, thus the higher the resolution. However, the resolution quality and the exposure range of an electronic camera is not as great as what can be achieved with film.



Electronic cameras use one of three devices to store images. These three devices are a 2-inch video floppy disk, a hard drive or Random-Access Memory (RAM), and an integrated circuit (IC) card or chip.

In the 1980s, the still-video camera was introduced in the Navy. The still-video camera uses a 2-inch video floppy disk capable of recording 50 or 25 images. The number of images that can be recorded on a floppy disk depends on whether the image is recorded in the "field" or "frame" mode.

The FIELD MODE uses one track per image on the floppy disk and allows 50 images to be recorded on one disk. The field mode provides poorer resolution because there are less pixels per picture. The FRAME MODE uses two tracks per image and allows 25 images to be stored on one floppy disk. The frame mode provides higher quality because more pixels per image are recorded.

Still-video cameras use an analog signal to record the images. This variable waveform represents density and colors that are created electronically by the intensity and the color of light striking an image sensor within the camera. This analog signal is the same type of signal used to record most motion-video images. It is also the same type of signal used in conventional television. Many still-video cameras have a playback capability and may be connected directly to a television monitor to view the images.

An analog signal records the lowest resolution of the electronic cameras, thus using the least amount of memory per image. Most still-video cameras have a limited resolution of approximately 380,000 pixels.

A still-video camera used by the Navy is the Sony Pro Mavica MVC-5000. This camera has three CCD chips that are used as the image pickup device and the high-band format to improve resolution.

An important factor to remember is that a still-video camera is an analog system, not a digital system. The format and configuration of a still-video floppy disk is different than that of a computer system, which is digital. By using the appropriate hardware and software, you must convert an image captured on a still-video camera from analog to digital format before it can be modified or printed in a digital-imaging system.

### **Still-Digital Cameras**

A still-digital camera is superior to a still-video camera. As the name implies, a still-digital camera

records an image in digital format. This digital format uses the binary system of "0s and 1s." The combination of these digits represents densities and colors created electronically by the intensity and the color of light striking an image sensor within the camera.

A digital image has a much higher resolution than an analog image. This higher resolution provides more pixels per image, but it also requires much more memory per image. Digital cameras use an IC card or chip and RAM or a hard drive. The RAM is built permanently into the camera and must be downloaded to another storage device. This storage device is an internal or external hard drive. This hard drive is similar to the hard drive found in personal computers. Kodak's Digital Camera System (DCS) uses a hard drive to store images.

The Kodak DCS still-digital camera combines a Nikon F-3 body and a standard lens with a digital-image back to capture high-resolution color or black-and-white images. The Nikon body operates similar to a camera with conventional film. The major difference between the Nikon being used with film compared to the DCS back is that the image area of the DCS is only one half of the size of a 35mm-film frame. This change in image area affects the effective focal length. For example, a conventional 35mm lens becomes a 70mm lens with the DCS. The Nikon F-3 functions, aperture settings, shutter speeds, and light metering operate the same as with film. Three major components that make up the Kodak DCS are as follows: an electronic back, a camera winder, and a digital storage unit.

Kodak's DCS models have a digital-image back that contains a 1,280 by 1,024 pixel CCD imager. This means the CCD is capable of recording about 1.3 million pixels. The color back equates to film speeds of 200, 400, and 800. The monochrome back equates to film speeds of 400, 800, 1600, and 3200.

With a winder (spooler), you can shoot up to 2.5 images per second. The system has a standard 6 megabyte (Mb) buffer that can store six images in one burst. Thus it is possible to shoot faster than the images are stored.

The camera body of the DCS 100 is tethered to a Digital Storage Unit (DSU) that contains a hard drive. The 200Mb hard drive can store 158 uncompressed images or about 600 compressed images. The DSU also has a key pad for system control and a 4-inch monochrome monitor so you can view the images immediately.

The Kodak DCS 200 is a modified Nikon 8008 equipped with a Kodak DCS 200 camera back (fig. 3-6). The DCS 200 is capable of 1.54 million pixels of resolution. It also has an internal hard drive that can store up to 50 images. A small "hitchhiker" 40Mb hard drive is also available. This 40Mb hard drive plugs directly into a small computer system interface (SCSI) port on the camera for additional image storage. The SCSI is pronounced SCUH-zee.

The advantages of the Kodak DCS 200 over the Kodak DCS are higher resolution and portability. It is more portable than the DCS because it has a built-in hard drive. The disadvantages of the DCS 200 are it stores less images than the DCS 100, and it has no built-in compression or transmission capabilities.

One of the biggest advantages of capturing an image digitally is the way the images can be processed. A digital image may be re-recorded without loss of image quality and the color and sharpness can be enhanced. This digital signal is identical to the signal used in a computer; thus, by using the proper interface, the signal from a digital-still camera can be imported directly into a computer.



Figure 3-6.—Kodak DCS 200.

## Scanners

Film transparencies, negatives, and prints are sources of images that can be produced and edited electronically. Scanners can create digitized images with extremely high resolution. Scanners are also capable of providing resolution equal to the original negative or print.

Scanners come in three categories: rotary drum, flatbed, and film. Rotary-drum scanners provide the highest quality for converting images from film or prints, but they are very expensive. Rotary-drum scanners are capable of producing resolution ranging from 1,000 to 5,000 dpi. When a rotary-drum scanner is used, the film or photograph is placed on the surface of a drum that rotates while the original is scanned by a single beam of light. The beam of light and the speed of the drum can be adjusted to control the amount of resolution desired.

Scanners that use charge-coupled devices (CCDs) provide excellent quality. They are used in many Navy imaging facilities. Scanners operate similar to a photocopy machine. A CCD chip with a row of light receptors scans a photograph or negative and changes the colors or shades of gray (analog signal) into digital values.

Full-color scanners have three rows of CCDs: one for red, one for green, and one for blue. This tricolor array permits full-color scanning with a single pass of the scanning head. The number of elements in the CCD array determines the resolution of the images being scanned. For example, an 8.5-inch linear array with 2,540 elements has approximately 300 elements per inch. This array can produce a digitized image with a resolution of 300 dots per inch (dpi). Most standard desktop scanners operate in the 300- to 400-dpi range. When an image is scanned on a scanner that produces 1,000 to 5,000 dpi, a higher resolution results, but the scan time and file size also increase. Generally, the resolution required for a scanned image is limited to the output of the imaging system.

A flatbed scanner is used for scanning photographs and artwork. Some flatbed scanners are also capable of scanning transparencies and color negatives. The resolution of flatbed scanners range from 200 to 1,200 dpi. Unlike a rotary-drum scanner, a flatbed scanner scans an entire line at one time with a linear CCD array.

Film scanners are used to scan negatives and transparencies. Many of these scanners come with software packages that allow you to crop the image and

make color corrections before the image is scanned into a digital file. By making these adjustments before scanning an image, you can save time and file size. Scanners are produced by a number of manufacturers. Scanners used in Navy imaging facilities are produced by Nikon and Kodak (fig. 3-7).

Once an image is converted to digital format, the data is passed from the scanner to the computer through an interface. Because of the enormous amount of data involved in electronic imaging, information is passed through a SCSI.

A SCSI is a special kind of parallel interface that allows for faster data transmission. The SCSI interface permits a number of peripheral devices to be connected to the computer through a single SCSI port. This is accomplished by chaining the devices together with a SCSI cable. The last device in the chain must have a special adapter, known as a terminator. Some devices have built-in terminators.

Each device in the SCSI chain is identified by a unique identification number. When the scanner is connected, you must verify that none of the peripherals have the same identification number. These identification numbers may be changed by using either dipswitch settings or software.

The scanner uses two programs to operate. One program is a paint program to manipulate the image once it is in the computer. The second program is a driver that acts as a translator between the scanner and the paint program. Once the image is digitized,

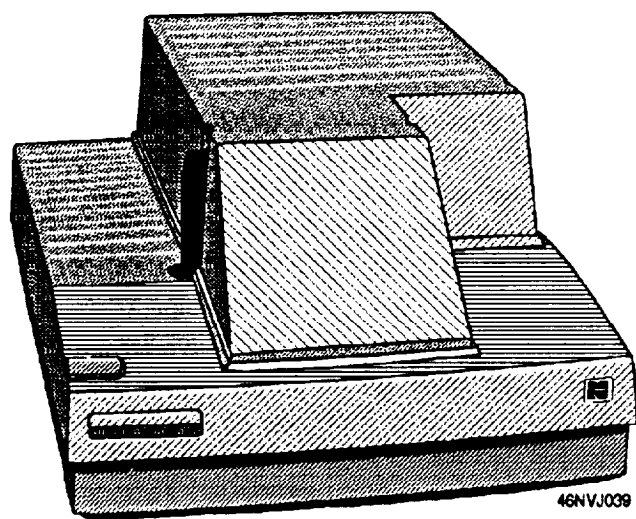

Figure 3-7.—Kodak 7720 thermal-dye transfer printer.

limitless modifications and enhancements can be made to the image.

Because a scanner scans at such high resolution, the end file is quite large. Thus a considerable amount of storage space is required. It is common for a 24-bit color image to require 20 to 25 megabytes of storage.

## COMPUTER PLATFORM AND SOFTWARE

The entire electronic workstation is designed around a computer (fig. 3-8). There are three major computer platforms in use for digital photography—the Apple Macintosh, PCs (IBM or compatibles), and Unix-based machines. The most popular computer for digital imaging is the Apple Macintosh. However, PCs and IBM compatibles are also used for digital imaging. They are becoming more popular in the digital-imaging marketplace. Unix-based workstations are used for science-oriented operations and high-volume publishing of books and technical manuals. Therefore, Unix-based machines are not commonly found in Navy imaging facilities.

Regardless of whether you are using an IBM compatible or a Macintosh platform for electronic imaging, the applications are basically the same. Specific computer systems are not covered in this training manual. Only the principles that apply to electronic imaging are discussed.

### Computer Configurations

As a guideline, the computer must have a minimum of 8Mb of RAM. For work efficiency, you need at least 32Mb of RAM. Storage may also become a problem because of the large-size file of color digital images. A high-resolution scanned image can require 250 megabytes or more of memory. A hard drive in excess of 600Mb is not uncommon for an electronic-imaging workstation.

The computer system must also have sufficient expansion slots to install interface cards for add-on peripherals, such as scanners, film recorders, and printers. A number of interface cards are available for both Macintosh and PCs that convert analog images to digital format.

### Software

Like computer platforms, a vast number of software packages are available for scanning and modifying images. Computer software (programs) makes it possible for you to communicate with the hardware.

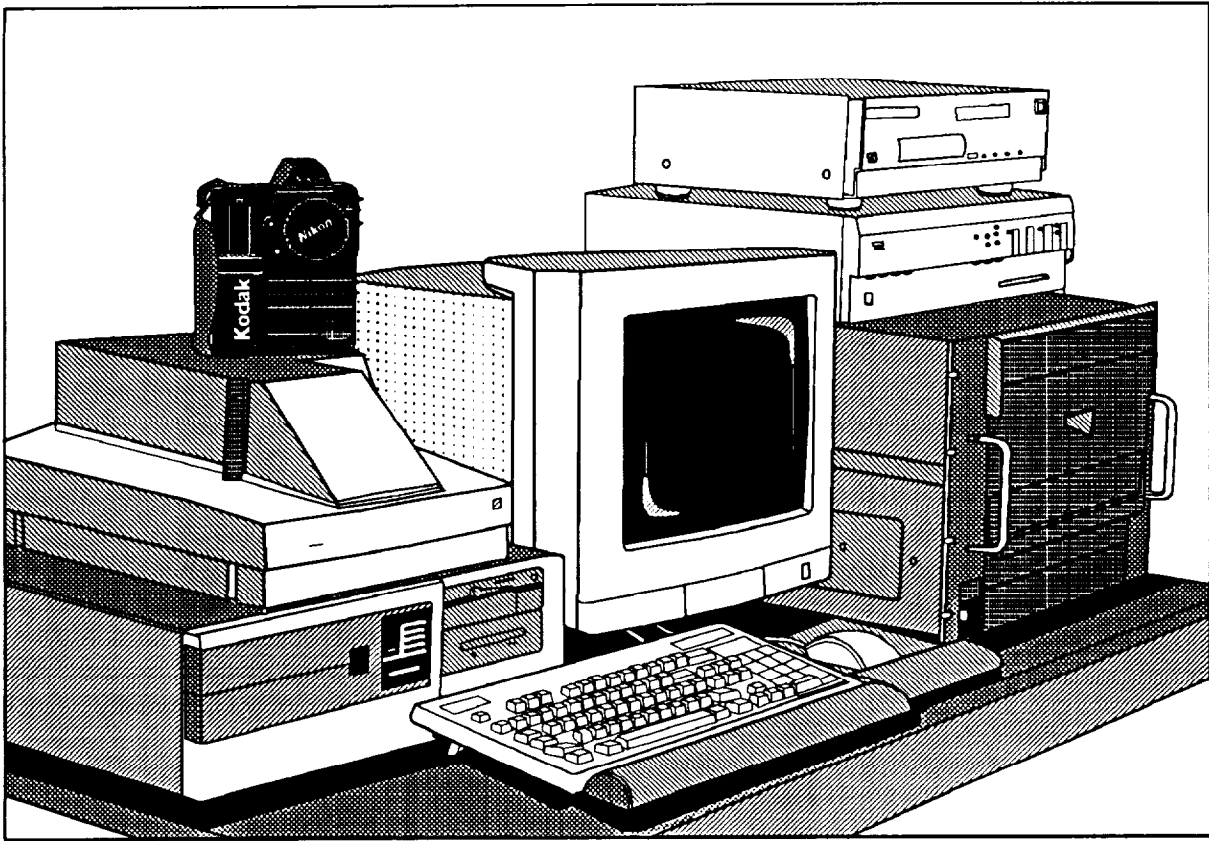

46NVJ040

Figure 3-8.—Electronic imaging workstation centered around an AT computer.

These software packages are capable of doing more than you could accomplish in a conventional darkroom; they do it much quicker.

Advancements in the development of software packages have made it possible to transform computer imaging from minicomputers or mainframe computers to desktop models. Because software is continually being improved and updated, the application of specific computer software is not addressed in this chapter. Software packages are used to modify and enhance images and to control input and output devices.

## DISPLAYS

Most of the computer color monitors available for desktop computers have far less resolution than a digital photograph. A number of graphic boards are available for computers that can produce Super VGA resolution of more than 1,000 by 1,000 pixels on cathode-ray tube (CRT) color displays. A high-resolution, noninterlaced monitor and a 24-bit video card are essential viewing images. A 24-bit video card allows for 16.8 million colors to be displayed.

Graphic images displayed on a computer monitor are bit-mapped images. Bit-mapped images are produced by a pattern of dots. Bit-mapped images are sometimes called "pixel-oriented," "raster," or "paint" images. At high resolutions, the individual dots are not discernable.

When you are working on enhancement, modifications, and page makeup of digital images, it is important for you to view what you have done. Therefore, a calibrated color monitor is important so you can see the images or "soft proofing" before you print the images. Monitors for electronic imaging use the additive system. They combine red, green, and blue and add it to the black surface of the screen to create colors.

Monitor quality depends on screen resolution. The finer the pitch of the screen, the sharper the image. The PITCH of the screen is the size of a single pixel. On color CRT screens, a single pixel is composed of three phosphor dots: red, blue, and green. These phosphor dots are struck by an electron gun through a screen or mask. The resolution of the CRT depends on the size of the holes in the mask. The holes in the mask are

necessary to direct the electron beam so it strikes the correct phosphor dots as the electron gun scans the screen (fig. 3-9).

Color monitors are available from standard EGA levels to pixel levels of 2,048 by 2,048. The monitor that is selected for your imaging system must match the display card in the computer, since it is the display card that limits the resolution of the monitor.

### DIGITAL-IMAGE FILE STORAGE

Color digital images take up an extremely large amount of memory when they are stored. Methods, such as optical media, have been developed to overcome this storage problem. Optical media is very suitable for storing digital photographs. Some examples of optical media include the following: Write Once, Read Many (WORM) disks, erasable optical disks, and optical memory cards. An example of nonerasable memory is the Kodak Photo CD; this CD allows high-quality color images to be stored for archival and retrieval purposes.

One Kodak Photo CD can store up to 650 megabytes. This equates to 100 high-resolution, color digital images when stored in compressed form. These images are stored at five different resolution levels, ranging from 128 by 192 pixels for a proof, or thumbnail sketch, to a high resolution 2,084 by 3,072 pixels (compressed) full-color image. These images can be imported using photo software packages, then they can

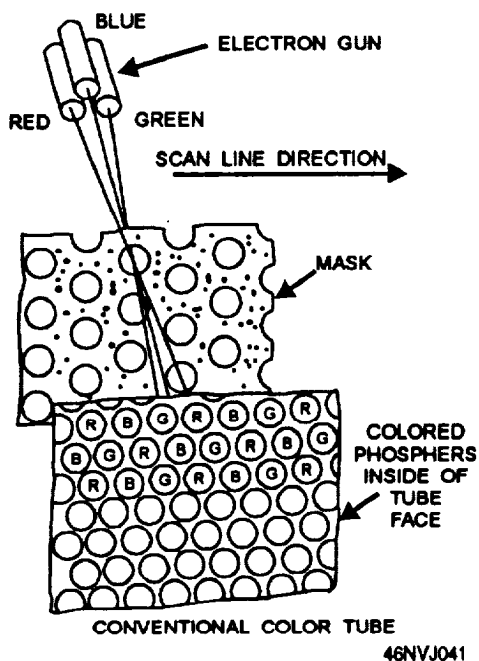

Figure 3-9.—Cross section of a CRT.

be manipulated, printed, or placed in various layout applications.

Image compression makes it possible to take a large color-image file and reduce its size. This reduces the amount of memory required to store it or decreases the time required to transmit it. Compression can reduce the amount of memory needed by a factor from five to one hundred. Various compression-decompression chips, add-on boards, and software are available in the commercial market.

Image compression is made possible because in a typical digitized image, the same information appears several times. For example, areas of the same color in different parts of the image or straight lines contain the same information. This duplication of information values, or REDUNDANCY, can be identified in three types as follows:

- Spatial redundancy. This results from dependence among neighboring pixel values.
- Spectral redundancy. This results from an association of color (RGB) planes.
- Temporal redundancy. This results from a correlation between different frames in a sequence of images.

The most common compression program has been formed by the Joint Photographic Experts Group (JPEG). The technique used in JPEG compression allows the user to select the compression ratio.

High-compression ratios generally result in low image quality. This low image quality is a result of avoiding the risk of losing data as the image compression ratio is increased. The amount of image compression depends on the amount of redundancy that exists in an image. When a compressed image is reconstructed (uncompressed) and the pixel values are identical to the original image, the compression is known as lossless. When discrepancies occur between the original and the reconstructed image, the compression is called lossy. Lossless compressions can be achieved with compression ratios of up to 5 to 1. Files that are compressed may be identified by the file extension ".JPG."

### HARDCOPY OUTPUT

A number of methods for making digital photographs are used. Some of these technologies include the thermal-dye transfer, inkjet, thermal-wax

transfer, and printers that use silver-halide photographic paper to produce digital images. Color copiers can also be used to print digital images to provide suitable quality at high speed and relatively low cost. Like most electronic equipment, a large variety of printers are available on the market. They range from hundreds to thousands of dollars.

Most printers used for making color prints from digital images use three colors: cyan, yellow, and magenta (CYM). Some printers match the full cyan, yellow, magenta, and black (CY MK) process.

Located between the printer and the computer is a RASTER IMAGE PROCESSOR (RIP) or a PAGE DESCRIPTION LANGUAGE (PDL). This is a software and hardware configuration that permits information to flow to the printer so the printer knows where to place the image on the paper.

### Thermal-Dye Transfer Printers

Thermal-dye transfer printers are often called dye-sublimation or dye-diffusion thermal-transfer printers. This system provides high quality and an environmentally safe method of transferring images to print and transparency materials without using chemicals (fig. 3-10).

The thermal-dye transfer printing process uses thousands of tiny heating elements that come in contact with "donor ribbons." Each donor ribbon releases a gaseous color dye when heated. Three-color printers have cyan, magenta, and yellow ribbons (CMY); four-color printers also include a separate black ribbon (CMYK). The amount of heat from each element

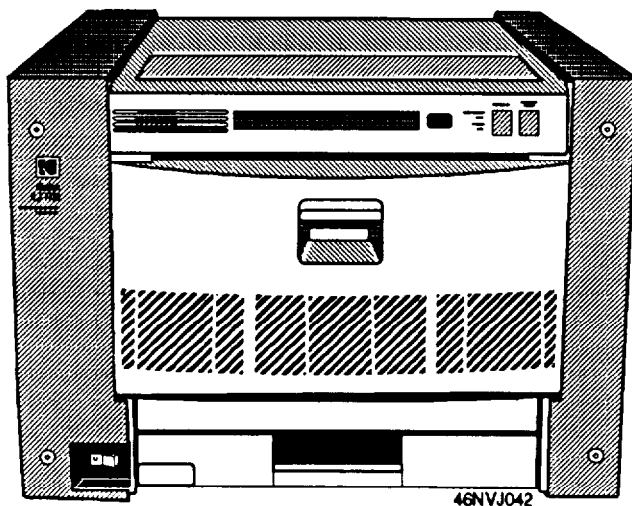

Figure 3-10.—Kodak 7720 thermal-dye transfer printer.

controls the amount of dye being transferred to the print material. The blend of the gaseous colors creates a continuous-tone image.

The quality of a thermal-dye transfer print resembles a print made from conventional silver-halide paper. The resolution of thermal-dye transfer printers ranges from 160 to 300 dpi. Resolution is limited by the thermal printing head. Thermal-dye transfer printers can produce prints from 3.5 by 5 inches up to 14 by 17 inches.

### Inkjet Printers

Inkjet printers are used in a variety of situations from newsprint to transparency materials. Inkjet printers use cyan, magenta, yellow, or black streams of ink to produce images. Inkjet printers today are capable of producing excellent continuous-tone color prints by using variable-size dots of ink that are precisely controlled. Inkjet printers are nonimpact printers that use droplets of ink. As the head of the printer moves across the surface of the paper, it shoots a stream of tiny electrostatically charged ink drops at the paper.

### Color Copiers

Color copiers were originally designed strictly for copying color originals. Today, however, color copiers have the added capability of copying transparencies and being connected directly to imaging workstations through an interface. This interface accepts digital signals to produce color photographs.

Color copiers are capable of producing prints with a true photographic appearance. One minor drawback to prints produced on color copiers is they are printed on plain, bond paper stock. Color copiers use a laser device that fuses toner to paper to create the image.

Some color copiers, such as the Canon Color Laser Copier 500 (fig. 3-11), can be used as a flatbed scanner in addition to providing high-quality color images directly from computer files. The resolution of such color copiers is 400 dpi on standard copier paper.

### Thermal-Wax Transfer Printers

Thermal-wax transfer printers operate on the same principle as thermal-dye transfer printers. Thermal-wax transfer printers use cyan, magenta, and yellow wax type of pigments instead of ink to produce images.

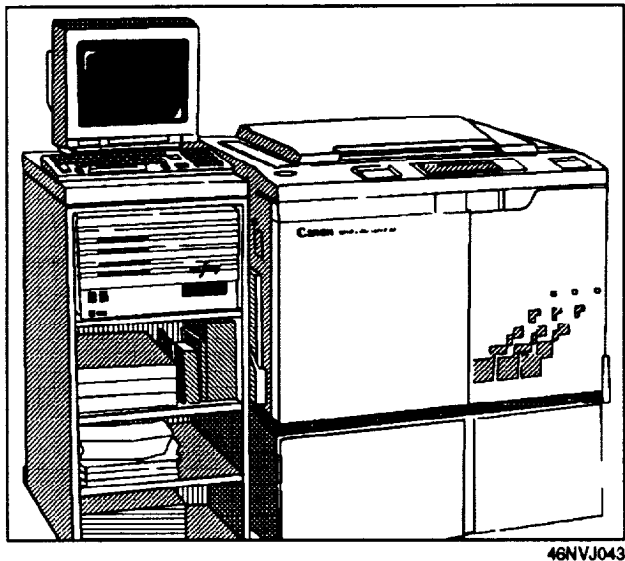

Figure 3-11.—Canon 500 color copier with the EFI Fiery controller.

Thermal-wax printers are designed to produce clean, bright colors; however, they have a limited range of colors because these printers are only capable of producing colors that are one-bit per color deep. These printers are relatively inexpensive and can produce large prints quickly.

## EDITING DIGITAL IMAGES

To edit digital images, you must rely heavily on computer software. The software allows you to manipulate the image. You can crop, retouch, and change colors of the entire image or any section of the image. With the powerful software packages available, you can change the original image into something completely different by merging one digital image with another. The scope of the aesthetic and creative aspects of the final digital image is limitless.

Editing digital images involves using graphic-interface software. This type of software is much easier to learn than text-based software. There are two essential elements of graphic-interface software: MOUSE and a BIT-MAPPED DISPLAY. The mouse is a small hand-held device that must be connected by a cable to a computer. When you manipulate the mouse on a desktop, it causes the cursor to move on the screen of the computer monitor. This method allows you to move files, run programs, draw lines, and execute commands. You can accomplish this by moving the mouse to the appropriate location and "clicking" a button. A bit-mapped display is composed

of tiny dots that are turned on or off individually; this allows the computer to show graphic images in addition to text. Bit-mapped displays are used in Apple application software and Microsoft "Windows" programs.

Graphical interfaces are easy to use because they provide a "point and click" approach to operating software. Files and software functions are displayed as small graphical icons (fig. 3-12). For example, an icon bearing the image of a folder may represent a file; or an icon bearing the image of a magnifying glass may allow you to zoom in on a portion of the screen. Graphical interfaces also use WINDOWS. A window can be compared to an open drawer (folder) of a file cabinet (hard drive). Windows are displayed as frames on the screen. These display different "files" in the "folder."

Two software packages used in Navy imaging facilities for electronic imaging are Adobe *Photoshop* and Aldus *PhotoStyler*. These software packages are not just photographic editing and enhancement tools but complete illustration programs. These two programs operate in the same manner. With "hands on" experience, you will soon become proficient.

*Photoshop* is available for both Macintosh and PC/windows platforms. *PhotoStyler* is designed for use in the PC windows environment only. Figure 3-13 shows some of the tools available in these two computer programs. As you can see, these two imaging software packages are very similar.

Although there are several software packages available for editing electronic images, they are all similar. These similarities are as follows: paint tools, selection tools, filters, and color correction.

## PAINT TOOLS

Paint tools allow you to retouch or add selected colors to an image. The tools typically include a paintbrush that allows you to draw in a color or pattern, a paint bucket that allows you to pour a color or pattern into a selected section of an image, and a spray paint tool that provides you with an airbrush effect. These image-editing programs allow you to perform color correction and to change contrast and density of the image. Other common tools may include a pencil for adding or deleting pixels, a teardrop for softening edges, and a finger paint or smudging tool for smudging colors.

An interesting option in most image-editing programs is the cloning tool. To use the cloning tool, you first select the icon; then you must click the mouse



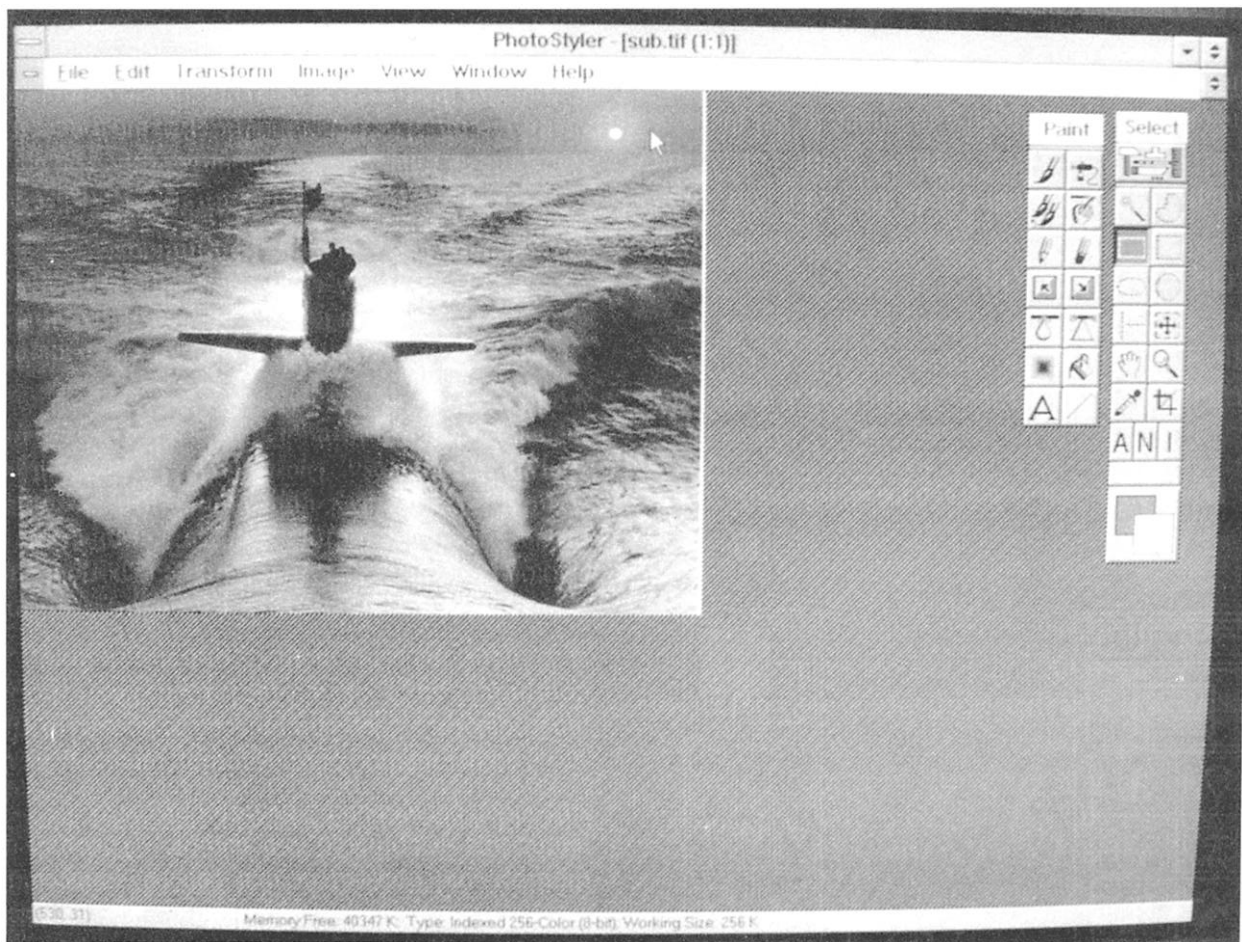

Figure 3-12.—Open file displayed on PhotoStyler palette.

button after moving the cursor to the portion of an image that you want to replicate. Now move the cursor to the part of the image where you want to "paint" the image that you selected (fig. 3-14). This cloning tool is particularly useful for removing dust spots, scratches, reflections, and so forth.

The imageediting software used by Navy imaging commands allows you to modify the way these tools function. You can change the size and shape of the brushes, soften the edges of the tools, and control the transparency of selected colors.

## SELECTION TOOLS

Selection tools allow you to select portions of an image and to perform a variety of operations. When using *Photoshop* or *PhotoStyler*, you have a high degree of control in editing, retouching, or manipulating images. A rectangular tool allows you to select rectangular areas and a lasso tool allows you to select

objects with irregular shapes. Another tool allows you to select a color from a portion of an image by clicking on it; you can clone it and replicate it elsewhere. By using these tools, you can add an aircraft formation to the image of an aircraft carrier. Then, using a blending tool, you can blend the two images smoothly. Other tools allow you to stretch or rotate images. Some programs have a magic wand tool that allows you to click inside an irregular-shaped object, and it isolates this object automatically (fig. 3-15).

## FILTERS

The filter features provided in image-editing software control the image brightness and contrast as well as sharpen or soften selected portions of the image. Some programs provide a "mosaic" filter so you can convert a portion of the image into large-size pixel areas. You have probably seen this effect used for



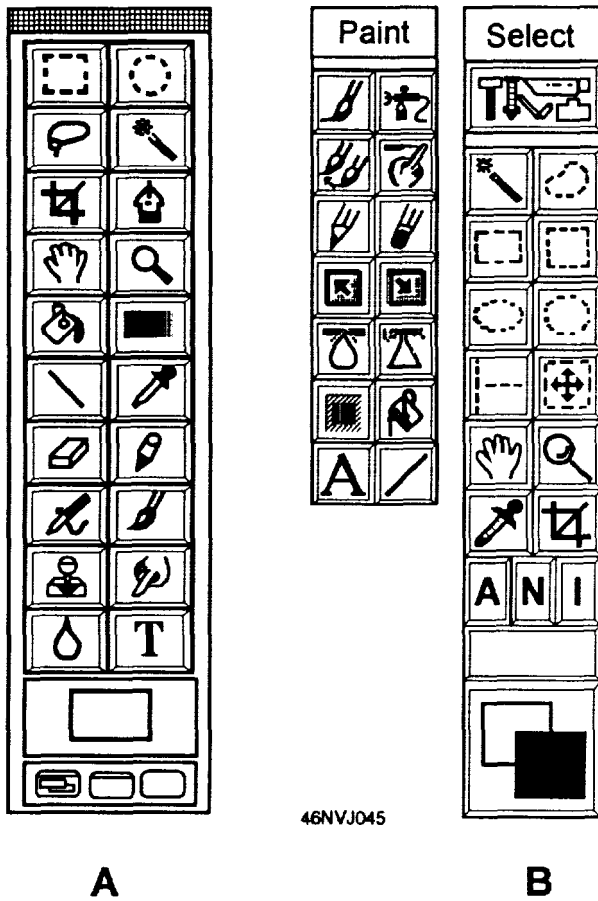

Figure 3-13.—Photoshop and PhotoStyler tools.

television interviews where people do not want their identity revealed.

### COLOR CORRECTION

Imageediting programs also offer color correction and calibration features. These color correction features allow you to modify an image to get the best possible quality to a color printer or other output device (fig. 3-16). These color corrections are accomplished by using a gamma curve.

The gamma curve represents the pixel values in the original image on the horizontal axis. The corresponding values of the displayed image are represented on the vertical axis. Separate red, green, and blue lines may be displayed so you can modify each color independently. By increasing the slope, you can raise the contrast level; this forces most of the pixels toward the light and dark ends of the spectrum. By raising or lowering the entire line, you can adjust the brightness.

### TRANSMITTING DIGITAL IMAGES

One of the biggest advantages of electronic imaging is time. After a photograph is taken, it can be transmitted anywhere in the world in a matter of seconds. This makes images available immediately. This immediacy is both critical and valuable to civilian media teams and military organizations. With electronic imaging, there is no film processing or printing. What you need to do is activate a transmitter and send it.

Several methods of transmitting electronic images are used. One method of transmitting the image is using the Sony Digital Information Handler with the Kodak DCS 100. The Sony Digital Information Handler is a digitizer and transceiver that can be connected to a phone line or uplinked to a satellite. This unit uses a still-video camera and 2-inch floppy disk.

Another method of transmitting images is by use of the Kodak DCS 200. This unit can be hooked to a laptop computer, such as a MacIntosh Powerbook, to accomplish the same methods of transmission.

Companies, such as Harris Corporation and Phototelesis Inc., have built rugged, portable image processing workstations that are compatible with standard U.S. Navy communication systems and encryption devices. These devices provide a secure means for transmitting tactical intelligence images worldwide.

One problem you may encounter when attempting to transmit images is locating a clear phone line or an available satellite. A clear phone line is necessary to ensure that a good image is transmitted.

Another factor you must consider when transmitting images is the amount of time you are tying up the circuit. The larger the file size, the longer it takes to transmit the file. It is good practice to compress files before transmission. When files are received at the other end, they can be decompressed without losing quality.

You can see the major advantages of electronic imaging. Images that used to take days or even weeks to obtain can now be obtained in minutes.

### ETHICS AND THE ELECTRONIC IMAGE

The adoption and popularity of electronic imaging raises important ethical questions. The altering of images has existed since the beginning of photography.

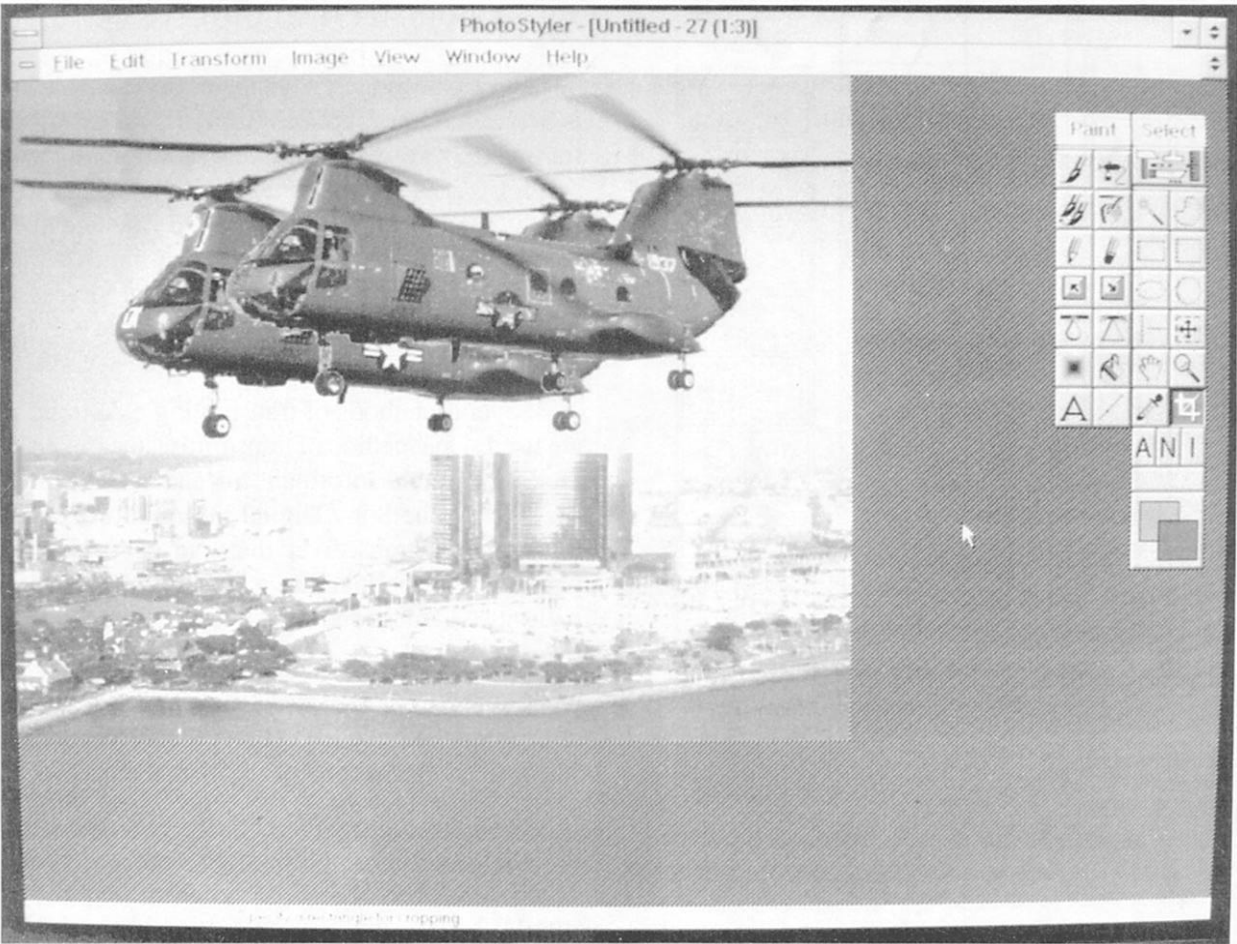

**Figure 3-14.—The cloning device was used to replicate a helicopter in this image.**

But, such manipulations have never been easy to achieve and were very time-consuming. However with electronic imaging, you can create images and manipulate images easily, completely, and it is virtually undetectable. Electronic information, unlike traditional photography, can be modified radically without loss of resolution or evidence that the information has been altered.

Official Navy images must be truthful. Most electronic images require some type of enhancement or manipulation, but you must not deceive the viewer when creating electronic images for official purposes. Some types of image manipulation are morally acceptable and others are not. You must have a clear understanding of what is considered deception.

"Deception" may be described as an intentional act to mislead someone to a false conclusion. Deception exists when a person is misled by an outright lie or by failing to provide a person with the relevant truth.

When manipulation of an image creates a false depiction of reality or when manipulation of an image fails to disclose some relevant piece of reality, the manipulation is deceptive.

To help you determine whether an action on an electronic workstation is ethical, you should draw a distinction between image manipulation and image enhancement. The following two scenarios are provided to help you arrive at the difference between image manipulation and image enhancement.

1. An obviously overweight male LCDR comes into the portrait studio for a full-length photograph. This photograph is for use for a promotion package. It is neither acceptable nor ethical for you to manipulate this person's image by stretching and slimming his body or superimposing his head on an image of a physically fit body. Removing a reflection from his glasses is an acceptable enhancement since it does not change his overall natural appearance.

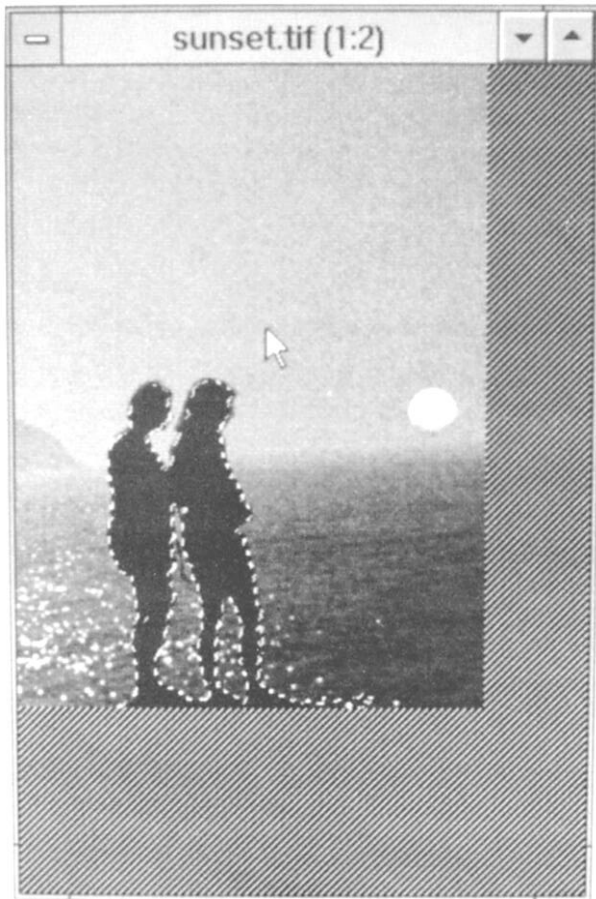

Figure 3-15.—Magic wand used in PhotoStyler to isolate the silhouette image.

2. You shoot a head-and-shoulder portrait of the new commanding officer. After pulling up the image on the monitor, you notice a smudge of lipstick on her teeth. It is acceptable and ethical for you to remove the lipstick from her teeth because this does not change her appearance. However, it is not ethical for you to straighten a crooked tooth because this changes her natural appearance.

Currently, official instructions and guidelines are nonexistent for electronic image enhancement or manipulation. Therefore, it is important for you to have high, personal, and ethical standards. Unlike conventional silver-halide photography where photographic prints can be compared with the original negative, digital images can be retouched or changed with absolutely no evidence of modification.

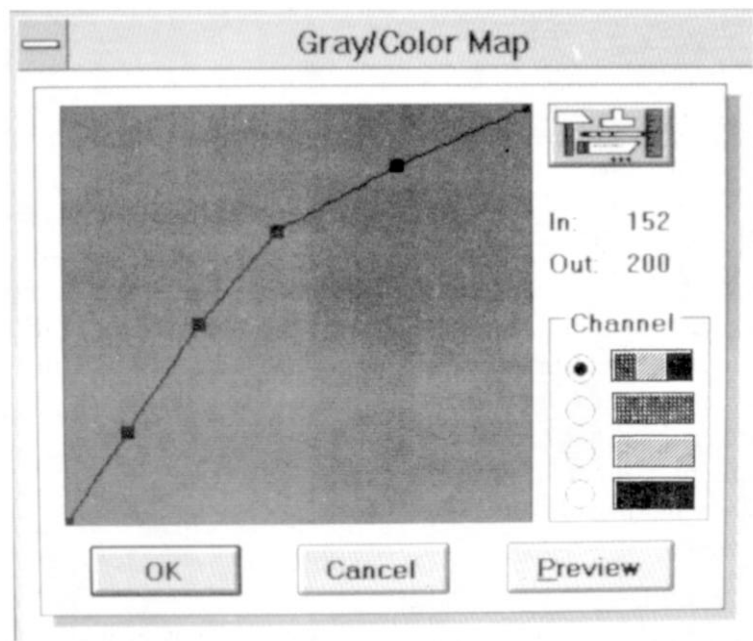

Figure 3-16.—Color correction tool used in PhotoStyler.



## CHAPTER 4

# AERIAL PHOTOGRAPHY

With the development of sophisticated airborne photographic systems, most aerial photographs today are made by photo-configured aircraft, such as the F-14 Tomcat with the Tactical Air Reconnaissance Pod System (TARPS). The role of the Photographer's Mate in aerial photography evolves less flying as a crew member and increased responsibilities in a ground-support function. Even with this changing role, you may be called upon from time to time to make hand-held vertical photographs and oblique photographs from airplanes and helicopters. This aerial photography could include such assignments as gunnery exercises, refueling at sea, publicity photography, construction progress, accident investigation, ship identification, display pictures, mapping, aerial motion-media work, and so on. As a knowledgeable PH you may also have to train non-photographic personnel in the operation of cameras and picture-making techniques for antisubmarine warfare and maritime surveillance photography.

Aerial photographs are taken from a variety of altitudes. The altitude ranges are defined as follows:

- Low altitude: 0 to 1,500 feet
- Medium altitude: 1,500 to 10,000 feet
- High altitude: 10,000 feet and above

As a Photographer's Mate, your aerial photographic assignments are normally accomplished from low to medium altitudes.

### CATEGORIES OF AERIAL PHOTOGRAPHY

Three basic categories of aerial photography are in use today: vertical, oblique, and air-to-air. The vertical and oblique categories are broken down further into types of aerial photography. The three basic categories are discussed first.

#### VERTICAL PHOTOGRAPHY

Vertical aerial photography is accomplished with the camera held or suspended in the aircraft, so it points

directly downward with the optical axis of the lens perpendicular to the ground (fig. 4-1). At the moment of exposure, when the camera is level and the film is parallel to the ground, the result is a photograph, for all practical purposes, with a uniform scale. However, if the aircraft is climbing, diving, banking, or the camera is tilted for any other reason at the moment of exposure, the resulting photography does not have a uniform scale. It is always important in vertical aerial photography to hold the camera in a true vertical position. The angle between the camera axis (or optical axis) and the true vertical position is called the TILT ANGLE; straight down, perpendicular to the ground, is 0 degrees, and straight out, parallel to the ground, is 90 degrees (fig. 4-2). The purpose of vertical aerial photography is to show details clearly of ground objects at a uniformly accurate scale. In peacetime, these aerial photographs are valuable for mapping and for planning locations of buildings, streets, runways, docks, and other similar projects. During wartime, vertical aerial photography is valuable for a variety of military purposes, such as determining enemy location, strength, and capability.

The entire view of a vertical image is not perfectly vertical because only the very center of the image area is taken straight down. A building in the center of a vertical image shows only the roof, but a building near the edge shows part of the sides in addition to the roof. Although this slight change in the viewing angle from center to edge of the image is undesirable when you try to match prints for laying strips or mosaics, it does provide the necessary differences in photos for stereo viewing.

Most vertical aerial photography is performed with photo-configured aircraft. It is possible, however, to make hand-held vertical photographs from planes and helicopters.

#### OBLIQUE PHOTOGRAPHY

An oblique aerial photograph is made with the camera directed out and down at an angle from the aircraft (not straight out and not straight down). For accuracy, the amount of the oblique angle is stated in degrees. The angle between the camera axis (or optical

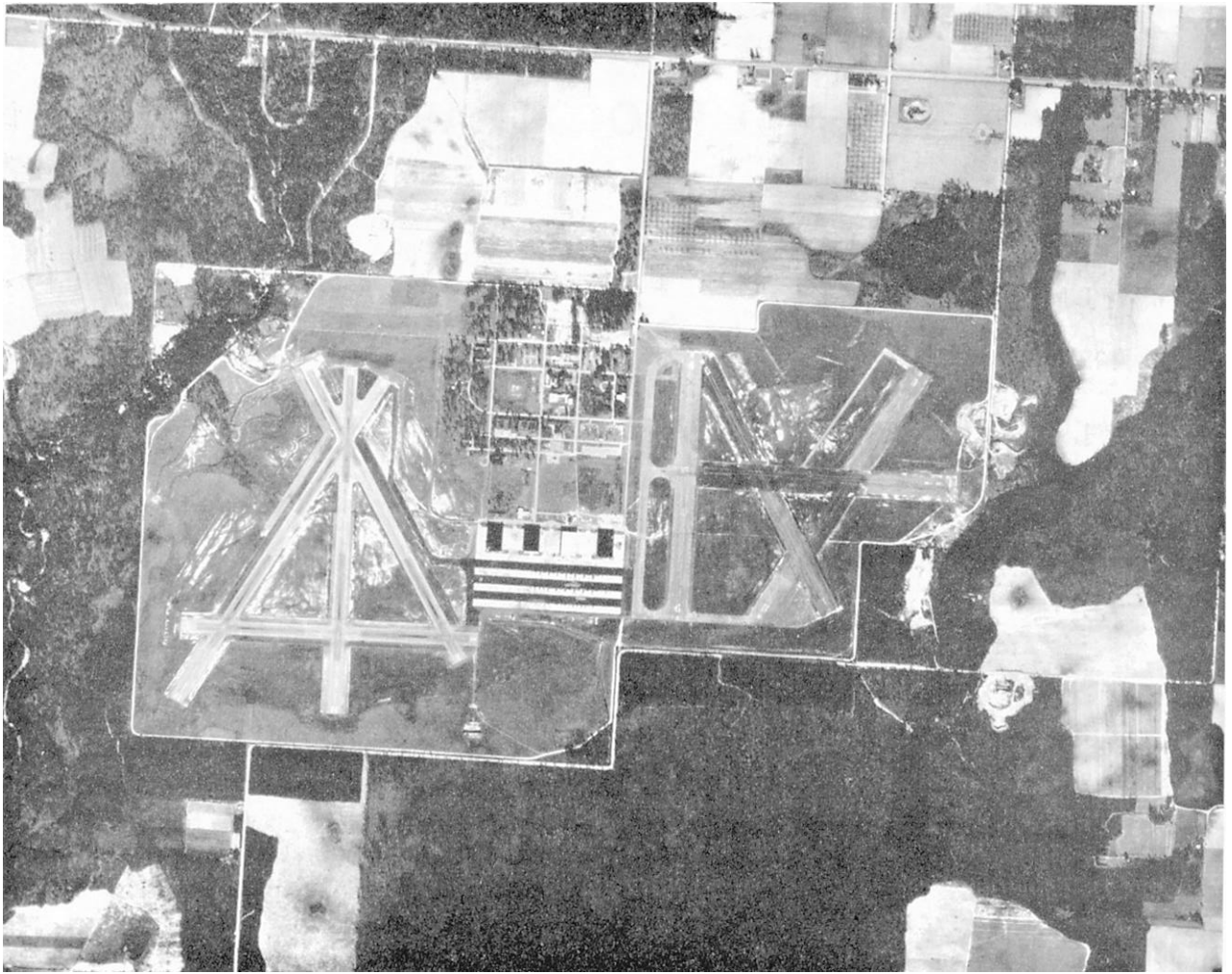

Figure 4-1.—Vertical photograph.

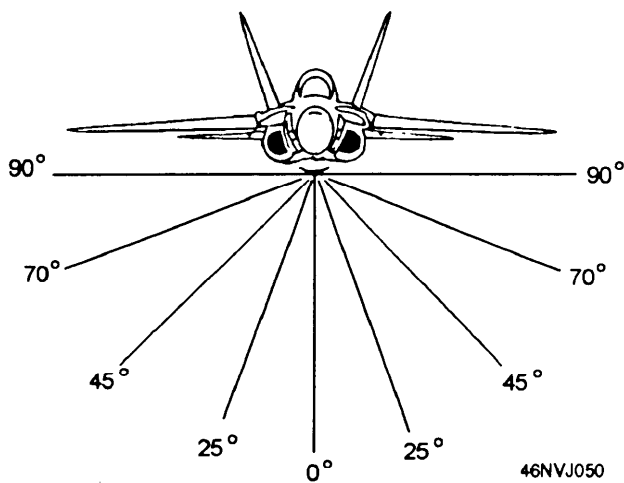

Figure 4-2.—Tilt angle.

axis) and the horizontal is called the CAMERA DEPRESSION ANGLE; straight out, parallel to the ground, is 0 degrees, and straight down, perpendicular

to the ground, is 90 degrees (fig. 4-3). Oblique images may be anywhere between 0 and 90 degrees, do not have a uniform scale, and are divided into two subcategories—high oblique and low oblique. The horizon is visible in high obliques but not in low obliques. This can be remembered easily by thinking *high sky, low no*.

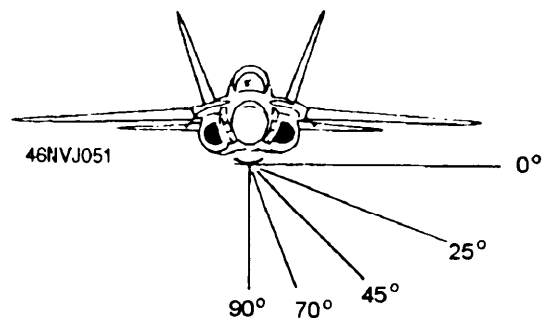

Figure 4-3.—Camera depression angle.

Here again, as with vertical photographs, oblique photographs can be made with photo-configured aircraft or with a hand-held camera.

### High-Oblique Photography

High-oblique photography is accomplished at a camera angle that shows the horizon at about a 30-degree camera depression angle (fig. 4-4). It resembles the view a pilot sees when approaching the target. High-oblique photographs are useful in guiding pilots toward a photographic target, a bombing target, or a helicopter landing site. High-oblique photographs are also used for orientation purposes because large areas are covered. A high-oblique photograph is particularly suitable for pictorial and illustrative purposes because it provides a true perspective view of land surfaces. It is easier for a person on the ground to locate and identify objects in a high-oblique photograph than in a low oblique or vertical photograph.

### Low-Oblique Photography

Low-oblique photography does not show the horizon (fig. 4-5). It is made with a camera depression angle of about 60 degrees. A low-oblique photograph covers a relatively small area. The subjects in a low-oblique photograph look more familiar than in a vertical photograph—as if you were viewing them from the top of a tall building. A low-oblique photograph is normally used for identification purposes, and for that reason, a large image of the target is necessary.

You may at first come to the wrong conclusion, because of their names, that high- and low-oblique photographs are made from high and low altitudes, respectively. This is not the case. The aircraft altitude is not a determining factor in whether an oblique is classified as high or low. Remember, the horizon is the determining factor; *high sky, low no*. As a matter of fact, most high-oblique photographs are made from a



PH3 John Sokolowski



PH3 John Sokolowski



PH3 Jim Vidrive

Figure 4-4.—High-oblique aerial photographs.





*CDR John Leenhouts*



*PH3 Terry Beall*

**Figure 4-5.—Low-oblique aerial photographs.**



relatively low altitude and low-oblique photographs from a relatively high altitude.

### AIR-TO-AIR PHOTOGRAPHY

Air-to-air photography, as the name suggests, is photography taken from the air of a subject in the air, usually another aircraft. Air-to-air photography techniques are discussed later in this chapter.

### TYPES OF AERIAL PHOTOGRAPHY

The vertical and oblique categories of aerial photography are divided into several types of aerial photography. Types of aerial photography are designated by their composition. A PINPOINT aerial photograph contains a target small enough to be included in one exposure. Long, narrow targets are

photographed by making a series of overlapping exposures, called a STRIP. When several strips are pieced together to form one composite picture of a large area, it is called a MOSAIC. Two pictures photographed to provide a three-dimensional effect are called STEREO aerial photographs. However, there are some characteristics that all types of aerial photography must have. All aerial photography must be sharp, show great detail, and be composed properly, so it satisfies the need for which it was made.

### PINPOINT PHOTOGRAPHY

Pinpoint aerial photographs are usually made when the target, such as a building, a weapon, or a small encampment, is small enough to be included in one exposure (fig. 4-6). In the case of oblique photographs, you can make more than one shot of a pinpoint target to show the target from different angles. For instance, you



Figure 4-6.—Pinpoint aerial photograph.

might need two, three, or four pictures to show the different sides of a building; or you might make a near and a distant view of the pinpoint target—one to show detail and the other to show location. You can also make more than one shot to produce one large, detailed picture of a pinpoint target. In this case, three or four shots having a 60-percent overlap are made. For example, you may need three overlapping exposures to give a large, detailed view of both ends and the middle of a bridge. When the number of overlapped exposures is small, say four or less, either vertical or oblique photographs, the total composition may be called a pinpoint aerial photograph, but technically, it would be either a strip or a mosaic.

### **STRIP PHOTOGRAPHY**

A strip is a series of overlapping exposures matched together to form one long picture. A strip is used when your assignment calls for photographing long, narrow targets, such as railroads, highways, coastlines, rivers, and mountain ridges. You may hold the camera at any angle to make a strip; however, exposures made with the camera pointing straight down from the aircraft join together better and have the most consistent scale. A strip comprised of oblique views is called a PANORAMIC.

One long, continuous picture, made from a number of photographs, requires the images to be matched carefully so one picture ends where the next begins. Because the camera is in a different position for each exposure, a perfect match is impossible. But, by overlapping exposures and using only the central area of each picture, you can obtain a near-perfect result.

Once a strip is started, photographing it is a mechanical job because the aircraft flies at a constant speed and at a constant altitude. You should not alter the camera angle while exposing a strip, and you should make the exposures at regular intervals. Thus the longer the strip, the more an automatic camera system is preferred. The camera-to-scene distance must remain constant while you are making the strip. The smallest change in distance changes the image size and makes matching adjacent exposures extremely difficult, if not impossible.

### **MOSAIC PHOTOGRAPHY**

Large land areas are photographed in strips that overlap sideways. The strips are pieced together to form one large composite picture, called a MOSAIC. When photographing for mosaic purposes, you should keep the camera the same distance from the scene

throughout the photographing evolution. Mosaics are usually produced from vertical photographs made by aircraft with an automatic camera system.

### **STEREO PHOTOGRAPHY**

Two pictures of the same subject, photographed properly, can provide a stereoscopic or three-dimensional effect. The two pictures are called a STEREO, a STEREOPAIR, or a STEREOGRAM. The word *STEREOGRAM* indicates that the two pictures are mounted and ready for stereo viewing.

The primary purpose of stereo aerial photography is to provide measurements, such as height and depth, and detect features that are not visible in a regular photograph. Photo interpreters (Intelligence Specialists) are trained in stereo techniques to detect these fine points. Stereo photographs are produced by making two pictures of the same subject from slightly different positions. When the pictures are made from the same position, the two are identical and there is not a stereo effect. A very small shift in the camera position, between exposures, produces a very shallow stereoscopic depth. As you increase the shift in camera position between exposures, the apparent depth of the stereoscopic view increases. When the stereo effect is exaggerated—so hills appear steeper and depressions appear deeper than they really are—the effect is called *HYPERSTEREOSCOPY*. The terms *inverted stereo*, *pseudo stereo*, and *reverse stereo* refer to the effect of interchanging the position of the pictures, causing hills to appear as valleys and valleys to appear as hills.

### **RECONNAISSANCE PHOTOGRAPHY**

Another aspect of aerial photography that you should be concerned with is reconnaissance photography. The Navy performs aerial reconnaissance photography of enemy territory to observe enemy defenses, troop concentrations, troop movements, enemy strength, and so on. Aerial reconnaissance photography may also include taking images over friendly territory, both ours and our Allies. This is discussed further in the TARPS section of this chapter.

### **CARTOGRAPHIC PHOTOGRAPHY**

Cartographic photography is accomplished for the purpose of making charts and maps. Usually several strips are flown over known landmarks that are used as reference points or ground-control points. Cartographic photography always has vertical views

but may include oblique views that are made simultaneously to produce horizon-to-horizon coverage along the flight line.

### **AERIAL PHOTOGRAPHIC SYSTEM**

An aerial photographic system may simply be the same hand-held camera you use on the ground, or it may be a complex, pilot-controlled electronic system, such as TARPS. The following discussion is only a brief overview of TARPS along with a brief explanation of aircraft cameras and associated equipment. Hand-held systems are addressed later in this chapter under the heading “Shooting Hand-held Aerial Photography.”

### **TACTICAL AIR RECONNAISSANCE POD SYSTEM (TARPS)**

With the development of F-14 Tomcats equipped with the Tactical Air Reconnaissance Pod System

(TARPS), the Navy continues to improve its photographic reconnaissance capabilities (fig. 4-7). TARPS, when fully configured for the tactical reconnaissance function, contains two photographic sensors (cameras): one infrared reconnaissance set (IRRS)—the electronics required to operate the cameras and the IRRS—and the auxiliary equipment to support the system (fig. 4-8). The TARPS can be used in a variety of tactical photo reconnaissance situations, such as target acquisition, prestrike target identification, poststrike target assessment, target tracking, maritime surveillance, and map surveillance. The TARPS is designed to provide day and night and low-to-high altitude reconnaissance. Operation of TARPS is controlled by the naval flight officer/radar intercept officer (NFO/RIO). Additionally, the pilot is provided with camera ON-OFF capability. The TARPS-equipped Tomcats retain a significant offensive capability, even when carrying out a photographic role. The aircraft can be returned to a full-combat



**Figure 4-7.—F-14 Tomcat equipped with TARPS.**

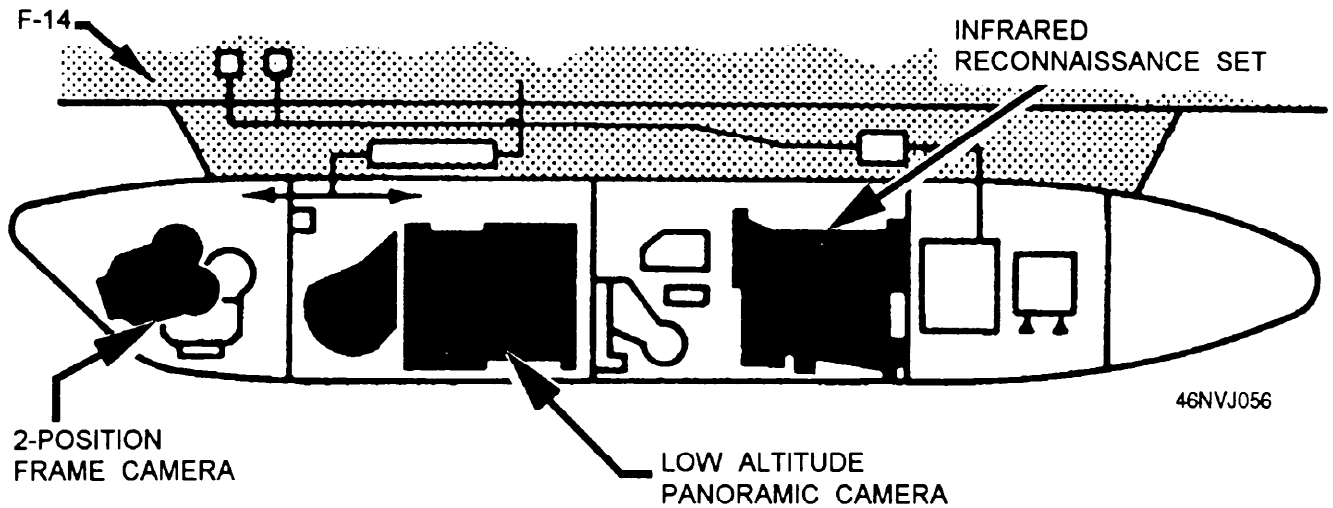

Figure 4-8.—TARPS.

configuration in a few minutes by removing the external TARPS.

Primary daylight photography from horizon to horizon is accomplished using the panoramic camera. This camera is located in the center area of the pod. The panoramic camera is used primarily for low-to-medium altitude reconnaissance, limited standoff, or coastal coverage. The frame camera, located in the front area of the pod, has two positions.

The frame camera is used for vertical photography or forward-oblique daylight photography. The frame camera in the forward-oblique position is useful for flight path plots, prestrike route segments, targets, and checkpoint photography. In the vertical position, a frame camera provides backup photography for bomb damage assessment (BDA), route area, ship photography, mapping, and some aspects of air-to-air photography. It is fully functional over a wide range of aircraft speeds and altitudes.

Both day and night reconnaissance can be accomplished using the infrared reconnaissance set located in the rear section of the pod. Multisensor reconnaissance involves using two or more similar sensors; for example, two or more photographic cameras with different focal lengths and depression angles, setting up the sensors with different spectral capabilities (photographic cameras using color film and an infrared detecting system, for example), or covering the same target area with two or more sensors during the same mission (fig. 4-9).

Tactical reconnaissance requirements are received from various levels of command and in various forms, including Special Intelligence Collection Requirements (SICRs), Naval Intelligence Collections Requirements (NICRs), and Essential Elements of Information (EEI). An EEI is normally originated by the task force commander or embarked flag; however, they may be derived from operational orders from the task force commander and directed by the carrier air wing (CAG) commander. The requirements for any reconnaissance recon) mission are generally passed from the CAG to the reconnaissance squadrons. The reconnaissance squadrons plan and execute a mission that will ultimately meet the objectives of the CAG.

At sea, TARPS is supported by the Carrier-Based Intelligence Center (CVIC) that is an operational intelligence center designed and developed to process, analyze, and correlate intelligence data from a variety of reconnaissance platforms. The support provided by CVIC includes film processing, image analysis and interpretation, and dissemination of intelligence information to operational commanders for planning tactical operations. Your primary responsibility as a Photographer's Mate is to process aerial film.

Each squadron having TARPS aircraft is assigned one photo officer and several enlisted Photographer's Mates who work in a ground-support role at the squadron level and as film processor operators in the CVIC. A Photographer's Mate that completes Fleet Readiness Aviation Maintenance Personnel (FRAMP)

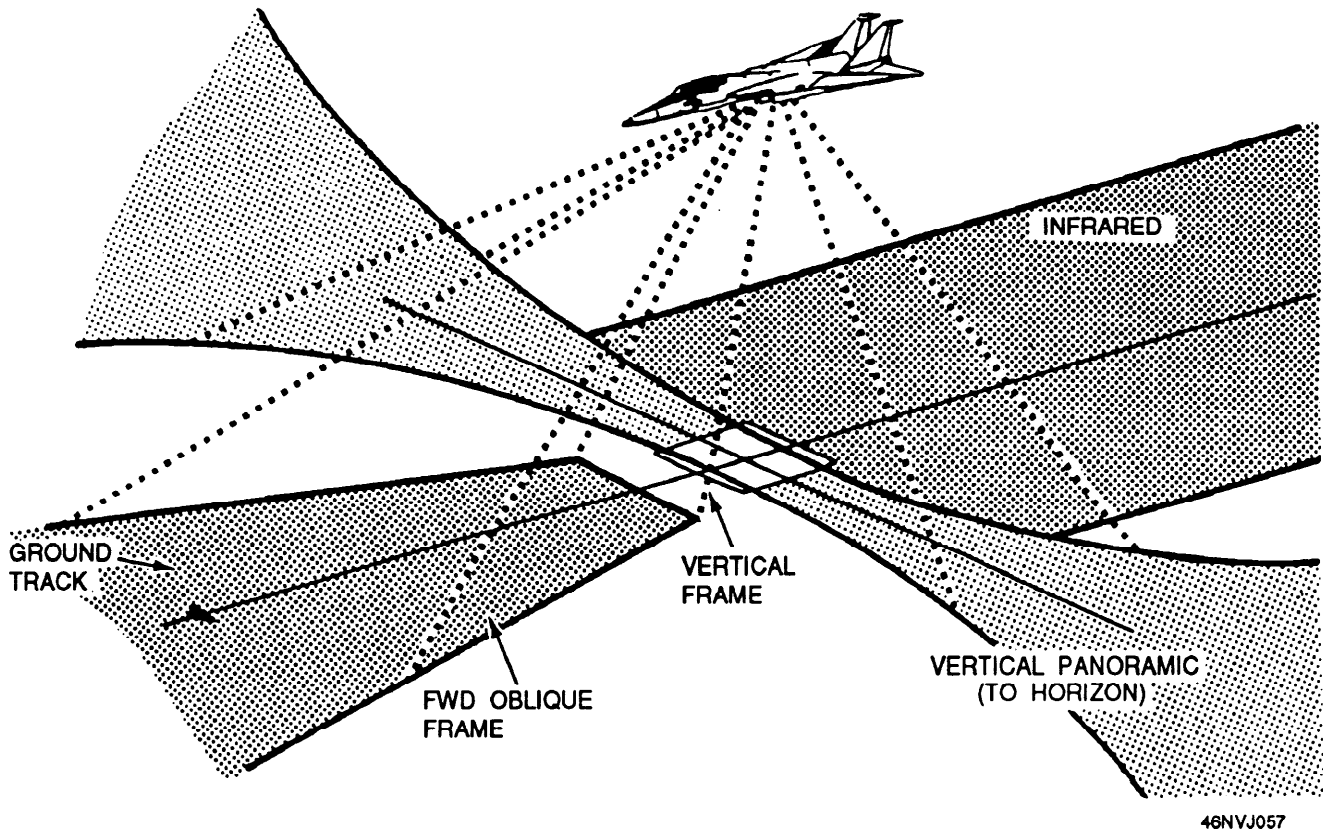

Figure 4-9.—Sensor coverage of TARPS.

Class C school (NEC 8345) is assigned to an F-14 squadron and is responsible for the maintenance of TARPS (fig. 4-10).

Currently the F/A-18 Hornet has a 35mm strike-camera capability installed in the nose of the aircraft. The F/A-18 is a supersonic, twin-engine jet designed as a multimission (fighter, attack, and reconnaissance) aircraft that has been in service since the 1980s.

## AERIAL CAMERAS

Aerial cameras, with few exceptions, have the same basic design. They have shutters, lenses, focal planes, drive mechanisms, film holders (magazines), and an assembly to hold the component parts in alignment. Aerial cameras are designed for either fixed installation or hand-held use. Fixed installation cameras are designed specifically for use in photo-configured aircraft. Hand-held aerial cameras are designed for use by PHs and by non-photographic aircrew personnel.

A system of joint military designators has been developed to provide identification for all aerial

cameras. This system assigns type designators for aerial cameras listed in *Military Standards*, MIL-STD-155A. Each category is assigned a distinctive letter designation to indicate a major item, accessory, attachment or component, and a mission letter to indicate the mission or function of each item. Each two-letter combination is provided with a model number assigned in numerical sequence and, when required, with a suffix letter assigned in alphabetical sequence to indicate various changes to the basic model. The category and mission letters for aerial cameras are as follows:

Picture-Taking Equipment:

Category Letter:

K—Camera

L—Accessories, Attachments, or Components  
for Cameras

Mission Letter:

A—Reconnaissance

B—Strike Recording



**Figure 4-10.—Photographer's Mates loading film in TARPS.**

- C—Aerial Mapping
- D—Scope Recording
- E—Still Picture (not otherwise classified)
- F—Motion Picture (not otherwise classified)
- G—Special Purpose (including instrumentation)
- M—Miscellaneous
- S—Set or System

Examples: (KS-87B): Camera, set or system, model 87, second production assignment. (KA-99A): Camera, reconnaissance, model 99, first production assignment.

### **SHOOTING HAND-HELD AERIAL PHOTOGRAPHY**

An aerial photographic mission involves careful planning, preparation, pilot and photographer

coordination, and photographing. Planning starts with a request for photographs and includes determining the type and number of photographs, type of camera, type of film, camera accessories, sequence of exposures, flight time, and flight path. To be successful, both pilot and photographer must know and understand the objective(s) of the mission. Questions to be answered during mission planning are as follows:

- What are the pictures to be used for?
- What should be shown in the pictures?
- What types of pictures are required (slides, prints, video, verticals, obliques, air-to-air, or others)?
- When are the pictures required?
- Where is the target located?

- What size is the target (subject)?
- At what time of day is the lighting best?
- From what direction should the pictures be taken?
- From approximately what altitude should the pictures be taken?
- What hazards to safe flight are present in the target area?

When the photographer and the pilot have the answers to these questions and understand the objectives of the mission, both are in a position to produce quality photographs that meet the needs of the requester.

To enable the photographer to take pictures, the pilot must know specific details about the mission. When taking photographs on the ground, you can choose to move either the object or yourself to get proper composition for your pictures. However, in the air, you must rely on the pilot for the desired camera angle and the correct camera-to-subject distance. The pilot cannot read your mind, so it is important to discuss your plans in detail before the flight. Remember, there is not time to accomplish this while you are both in flight.

Other reasons for discussing plans before the flight are as follows: the mission may require maneuvers the aircraft is incapable of performing or the pilot may perform a different maneuver to get the same results. On the ground, the photographer has sole control over the camera. In the air, the camera is, so to speak, in the hands of both the photographer and the pilot. Both must coordinate their efforts and work together as a team.

## MAPS AND CHARTS

For some aerial assignments, a map or chart is important for the successful accomplishment of an aerial photographic mission. You should become familiar with the different types of maps and charts available. A map is used primarily for land navigation, while a chart is used primarily for water navigation. Represented on a map or chart are the essential topographic features, such as water depths, roads, railroads, rivers, lakes, towns, cities, airfields, and other man-made objects.

The scale of a map or chart depends upon personal choice and availability. A large-scale map provides greater detail, while a small-scale map covers a larger area. The scale of the map you use should be large enough to define the target clearly yet small enough to include a large area surrounding the target.

Reading a map is easier when the top of the map is forward, so the map lies in front of you, just as the ground does. You may find the map easier to use during the flight when you write on it, so the top is in the main direction of flight. Once you have located the target on the map, you should mark it. Indicate the type of photograph and any other information that may be of assistance in your photographic mission, such as altitude, scale, and angle. Geometric North should also be marked on the map.

## WEATHER

Temperature inversion in the atmosphere tends to concentrate and trap particles in the air, causing haze. A common type of temperature inversion may be characterized by smoke that rises to a certain height,

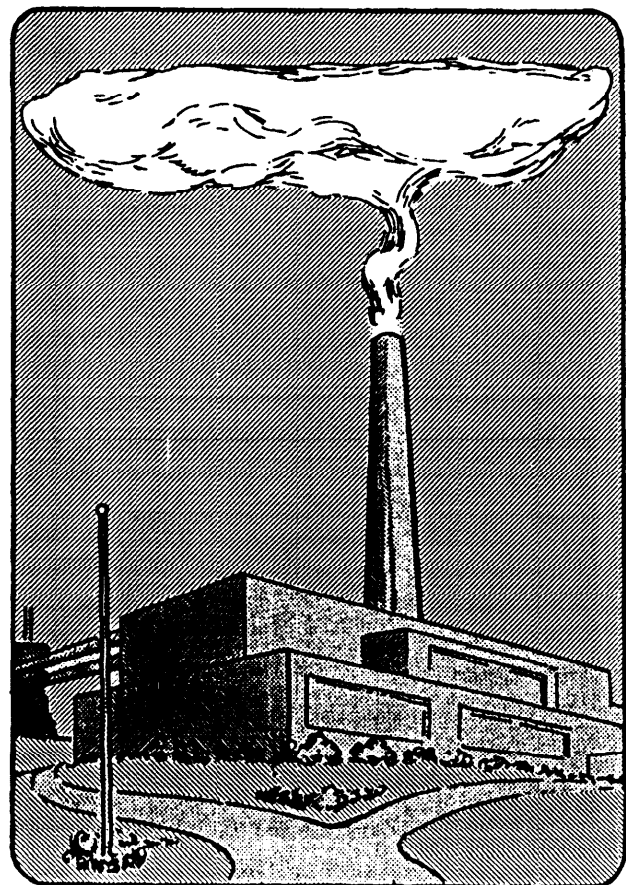

46NVJ058

Figure 4-11.—Characteristic of temperature inversion.



then flattens out and goes no higher (fig. 4-11). This condition makes it difficult to photograph the ground. In these circumstances, you can use film with extended red sensitivity or a red filter to help cut through the haze. There is nothing you can use to cut through the smoke.

Thermal shimmer is another condition with which you should be concerned. Thermal shimmer is the result of heated air moving upward. When thermal shimmer is occurring, distant objects appear to shimmer because the light rays are being refracted by the rising heated air. This occurrence can obscure minute detail in high-altitude photography. When thermal shimmer exists, you should take enough photographs to ensure that subject detail occurs in at least one photograph.

Good weather conditions for aerial photography are generally considered to be clear with 5 to 10 knots of wind (to help blow off smoke and smog) and visibility of 7 miles or more. Minimum conditions are generally considered to be scattered clouds with visibility of 6 miles. When weather conditions are poor, shoot

low-oblique photographs from relatively low altitudes. This helps to minimize the effects of smoke and haze.

## AIRCRAFT

After you have gained some experience in taking hand-held aerial pictures, you will probably have a preference for a particular type or model of aircraft. Hand-held aerial photographs can be made from almost any aircraft. However, there are some generally accepted preferences, such as high-wing aircraft or relatively slow-flying aircraft. Most slow-flying aircraft have a window, door, or hatch that can be removed or opened to simplify unobstructed photography. A high-wing plane is preferable to a low-wing plane because the wing is out of the field of view of the camera.

Helicopters provide photographers more freedom to work at lower altitudes, but there are certain misconceptions about them (fig. 4-12). One of these misconceptions is that the platform can be suspended



**Figure 4-12.—Helicopter used in an aerial photographic assignment.**

*JO3 Oscar Sosa*



anywhere in a motionless state. Most helicopter pilots prefer to maintain some forward speed—at least enough to make a safe landing in the event of engine failure. An added advantage of maintaining some forward speed is it reduces vibration. While the helicopter is hovering, it vibrates excessively and the engine exhaust oftentimes washes in front of you and the camera. Both of these factors contribute to unsharp photographs. There are two distinct advantages of using helicopters for hand-held aerial photography. First, they have the ability to maneuver in and out of places that are inaccessible to fixed-wing aircraft. Second, they have the ability to fly at low altitudes more safely than fixed-wing aircraft.

If you have a choice of aerial photographic platforms, consider an aircraft that can fly with a window or door removed or open. By removing or opening a window or door, you eliminate the need to shoot through a glass or plastic window. This prevents reflection problems, such as glare, that can result in obscured image detail. Of course, you are unable to open a "window" in a high-performance jet aircraft. Navy helicopters have doors that can be completely

removed or opened while in flight. With the door opened or removed from a helicopter, you have fewer obstructions to obscure the view of the camera than in a fixed-wing aircraft. You can generally sit with your legs hanging out of a helicopter (fig. 4-13). This is both convenient and comfortable for shooting your aerial pictures. Additionally, sitting on the floor with your legs out of the helicopter gives you a stable body position. It also enables you to lean out and see the target as you approach it.

## CAMERA SELECTION

The best camera for hand-held aerial photography is probably the one with which you are most familiar. This does not mean that you should disregard the excellent hand-held 70mm aerial cameras. If you have access to any of these aerial cameras, by all means give them a try. You may find them very much to your liking. These aerial cameras are top of the line and are capable of producing photographs of the highest quality.

What type of pictures are you going to take? What will they be used for? These factors have a big influence on what camera you select—35mm for slides or 120mm



**Figure 4-13.—Photographer shooting from helicopter.**

or 70mm for 16 x 20 inch or larger prints. There are many experienced aerial photographers, and because of varying experiences, they may have very different opinions. Most favor a medium-format camera when prints are required. Medium-format cameras are easy to handle in confined spaces—the back seat of a jet aircraft, for instance. They are relatively small and convenient to use. With careful processing and printing, almost any size of print can be made from the negatives produced by a medium-format camera.

Excellent results may be obtained by using a 35mm camera; assuming, of course, you handle the film carefully during processing and printing. Because of the variety of interchangeable lenses, small size, ease of handling, and large number of exposures, the 35mm camera is preferred by many Navy Photographer's Mates.

## FILM SELECTION

Aerial film is designed for high-altitude photography and does not yield better results than conventional films at low altitudes. Remember that most hand-held aerial photography is performed at low altitudes. There are several factors that you must consider before selecting a particular type of film. The first, of course, is the end use (purpose) of the pictures. Do you need black and white or color; prints or slides? Other important factors are as follows:

- Weather and haze conditions
- Lighting conditions
- Special purpose film (color, camouflage detection, and infrared (CDIR))
- Special filtration
- Processing requirements or capabilities

### Black-and-White Panchromatic Film

For an aerial assignment requiring black-and-white prints only, you should first consider a black-and-white film, such as Kodak Technical Pan (Tech. Pan.). This and other similar types of film are fast enough for most aerial work when the weather is good and the subject is well-lighted. The extended red sensitivity of Tech. Pan. also helps to penetrate haze. This film is readily available and convenient to process. Tech. Pan. has

excellent resolution and the extreme fine grain required to make high-quality enlargements.

Special types of film designed for reconnaissance are also available. These films are normally available only in rolls, and they range from 70mm to 12 inches wide. These films are characterized by their sensitivity, base type and thickness, speed, resolution, and granularity. These films also have an extended red sensitivity to aid in greater haze penetration.

Although black-and-white prints can be made from color negatives, it is better to use black-and-white film. Black-and-white film is superior to color emulsions in their ability to record image detail. Haze and contrast control are easier to achieve with black-and-white film than with color film (fig. 4-14).

### Black-and-White Infrared (IR) Film

In aerial photography, black-and-white infrared (IR) film offers several advantages over panchromatic film. Primarily it provides higher contrast and the unique ability to record detail through haze. Thus black-and-white IR film should be considered when aerial views must be taken under such conditions. This type of film can record more detail through haze than can be seen with the human eye. The sensitivity of IR film extends to approximately 900nm with maximum IR sensitivity from approximately 760nm to 880nm. It is particularly useful when extreme distances must be covered, such as high-altitude photography, or when a high angle of view is required for high obliques. Before selecting a black-and-white IR film, you should check with the person for whom you are doing the work. Prints made from black-and-white IR negatives appear quite contrasty because blue sky and water are reproduced almost black (fig. 4-15). Growing crops and deciduous trees appear white in photographs and most evergreens record darker. If such prints meet the requirements of the requester and IR film is the best choice, by all means use it. However, keep in mind that when black-and-white IR film is used, you must filter out blue and ultraviolet radiation with a red filter, such as a Kodak Wratten No. 25 or equivalent, for best results.

### Color Negative Film

Color negative film, such as Kodak Vericolor III Type S, may be used to provide color and black-and-white prints. However, when available, film, such as Kodak Vericolor HC, is a better choice. Kodak Vericolor HC provides better results because of the



**Figure 4-14.—Aerial photograph taken with black-and-white film without a filter.**

increased inherent contrast and color saturation of the film. When a high degree of magnification is required, Kodak Ektar film can provide excellent results. Color negative film has much better exposure latitude and is more versatile than color reversal film.

Color negative film is often an excellent choice for aerial photography, particularly when you are unaware of some possible uses for the photography, or there is more than one type of finished product. Black-and-white printing paper, designed to be processed through color-chemical processes, can provide excellent results, and color slides may be made easily by copying color prints.

### **Color Reversal Film**

When only color slides are required, you should choose a color reversal film, such as one of the Kodak Ektachrome films. This type of film comes in a number of ISO speeds and is excellent for making aerial slides.

High-speed color reversal film is useful for photography in the late afternoon or at dusk when the light level is low.

When you must take color pictures in a heavy haze or from high altitudes, contrast can be improved somewhat by having internegatives made from color slides. Color prints can also be made directly from color slides.

### **Infrared Color Film**

Infrared color aerial photography is useful for obtaining photographic information that is not available through conventional photography. Ordinary color film has three emulsion layers that are sensitive to blue, green, and red light; IR color film is sensitive to blue, green, red, and infrared radiation. The result is transparencies that reproduce original scene colors differently for most natural features. IR radiation appears as red, green reproduces as blue, red reproduces



**Figure 4-15.—Aerial photograph taken with black-and-white IR film and a filter.**

as green, and blue reproduces as black (because the film is exposed through a deep yellow filter). Many other colors are also formed, depending on the proportions of green, red, and infrared reflected from the original scene. Infrared color film was designed for camouflage detection, and it shows differences in infrared reflectance between live, healthy vegetation and areas visually similar, such as pseudo foliage and camouflage netting. Color IR film should be exposed through a minus blue (deep yellow) filter, such as a Kodak Wratten No. 12 or equivalent.

### **CAUTION**

Kodak Ektachrome Infrared film can not be processed in Process E-6. It must be processed in Process ME-4, Process EA-5, or Process E-4. Do not attempt to process Kodak Ektachrome Infrared film through

any type of E-6 processor. This could impair the processor and ruin the chemicals.

### **FILM SPEED**

A speed-rating method for aerial film is known as Aerial Film Speed (AFS). This speed-rating system is adopted by the American National Standards Institute (ANSI) and is used to establish the speed of aerial film. Effective Aerial Film Speed (EAFS) is used to describe the actual aerial film speed that results from processing film through any process other than the one specified by ANSI. Aerial Film Speed and Effective Aerial Film Speed should not be confused with ISO speed or exposure index (EI). They are NOT equivalent. When using ground pictorial films that are assigned an ISO speed, such as Vericolor, Ektachrome, or Technical Pan, you should conduct tests to determine which film speed settings for your camera or light meter will produce optimum results.

## FILTERS

Two main reasons for using filters in aerial photography are in use today—to control haze and to get a pure infrared photograph.

Aerial views photographed without a filter may appear flat because of atmospheric haze. This haze may become evident in aerial photos even when the pictures are made on "clear" days. Haze has the effect of reflecting and scattering the shorter wavelengths—ultraviolet radiation and blue light. Since all films are sensitive to these shorter wavelengths, they record as a veil over the scene when a filter is not used. This veiling of the image becomes more pronounced as the altitude of the aircraft is increased. This is because the mass of haze (water vapor and dust particles) between the aircraft and the ground increases. Filters used for controlling haze in aerial work range in color from light yellow to red. When you use these filters, the photographic image is recorded by light with a longer wavelength (green or red) that is not appreciably scattered by haze. Filters, such as Kodak Wratten No. 2B or 2E, absorb ultraviolet radiation and reduce the effects of haze without affecting the monochromatic rendering of visible colors. When greater haze control for black-and-white photography is required, deeper yellow or red filters should be used. However, when these deeper colored filters are used, the tonal rendering of colors is affected. The amount of haze control in black-and-white aerial photography increases with the use of the following filters in this order: No. 8 (yellow), No. 15 (deep yellow), and No. 25 (red). The greatest penetration or control of haze for black-and-white aerial photography can be obtained by using a black-and-white infrared sensitive film with a suitable filter, such as a No. 25, No. 29, No. 70, or No. 89B.

Haze filters for conventional color film are different from those normally used with black-and-white film because all colors of light must be used to obtain correct (true color) results. Filters used with color film are usually colorless or pale pink, such as a No. 1A Skylight filter, or one of several densities of pale yellow (No. 2B and 2E, for example). These filters are not dense enough to require additional exposure. On bright, clear days when haze is minimal and you are taking verticals or low obliques from altitudes below 2,000 feet, good color results may be obtained without using a filter. However, when haze is apparent or when you are taking high obliques, the use of a UV16, or 1A Skylight filter is recommended. From higher altitudes or when haze is a problem, consider using a No. 2B and No. 2E filter.

Keep in mind that different types of color film may require different filters. Filter requirements are listed with each package of film.

**NOTE:** Haze should not be confused with mist or fog, which affects film as a white or gray area. Haze penetration filters have no effect on mist or fog. Atmospheric haze is always present, but it is especially noticeable in distant scenes and from high altitudes.

## DETERMINING EXPOSURE

Determining proper exposure for aerial photography can be more complicated than determining exposure for ground photography. You can make exposure readings with your meter before leaving the ground to determine the proper exposure for ground photography. (Be sure to allow for the filter factor correction.) In most cases, for low level air-to-ground photography and for air-to-air photography, you should use about the same exposure in the air as you would use on the ground. Once you are airborne and before taking air-to-ground pictures, take a light meter reading of the ground from about the same altitude that you plan to work. When you are at a fairly low altitude with little or no visible haze, the exposure reading should be very similar to the ground exposure. So set the camera about halfway between the two readings. However, if you have noticeable haze or if you are working from a high altitude or if your air-to-air subject is far away, your airborne meter reading may be significantly higher than the ground reading. This is because your meter is affected by the large area of sky and the amount of light reflected by the haze. In this situation, the camera setting should be determined by the substitution method.

The substitution method is also an effective way of determining exposure. The gray wing of an aircraft or a suitable substitute may be used to determine basic exposure. In any event, bracket your exposure by at least one f/stop whenever possible. It is more economical to take a wide range of exposures than to re-fly a mission. High altitudes, the sky in high obliques, and high levels of haze reduce subject contrast and increase exposure latitude. These factors oftentimes cause overexposure.

## SHUTTER SPEED AND LENS APERTURE

Since depth of field is insignificant in air-to-ground photography, you can concentrate on the problem of objectionable image motion. Set the focus at infinity, and set the aperture wide open. There is no need to stop

down for depth of field, since the entire scene is effectively at infinity. (You may prefer to stop down one or two f/stops to obtain the critical aperture of the lens for the sharpest image.) Make necessary exposure adjustments by varying the shutter speed. With your lens wide open, you can use the fastest shutter speed that conditions will allow. Thus you are better able to reduce image motion.

For air-to-air photography, depth of field may be a factor you have to contend with, especially when you are making close-ups. You may have to stop down and use a slower shutter speed to get the required depth of field. This is not much of a problem because the photo "bird" (aircraft in which you are present) and the target, usually another plane, are flying at about the same speed and very little movement of the subject is apparent. You should use the fastest shutter speed possible to compensate for vibration of the aircraft in which you are flying.

## AERIAL MISSION CALCULATIONS

In the planning stage of an aerial mission, you must perform several calculations. Careful planning is important before preflight, so you, the pilot, and the flight crew know exactly what steps are required to fulfill mission requirements. The facts and requirements for a mapping mission consist of the required scale of the photography and the area to be photographed. Using this information, you can make several calculations to determine such factors as altitude, number of frames per flight line, number of flight lines, film requirements, and so forth. There are a number of methods and mathematical formulas that you can use to arrive at these conclusions. Through careful calculations, you can determine the following factors:

- Altitude
- Focal length
- Ground coverage in feet
- Number of passes required
- Scale
- Ground-gained forward
- Exposure interval or picture frequency

- Ground speed
- Shutter speed
- Altitude above the terrain
- Ground coverage
- Exposure interval
- Film usage

In vertical photography, the area covered by a photograph may be limited, particularly when the photograph is taken from a low altitude. From a high altitude, a larger area is included, but each part of the area is recorded smaller. To increase the area covered at a low altitude, you should make a series of overlapping photographs, then splice them together to form one large photograph (a strip or a mosaic). By doing so, you can cover a large area and the objects on the ground are reproduced in a relatively large image size.

**NOTE:** When working on planning calculations, recheck your work for accuracy. Certain steps of each problem are dependent upon other sections of the problem. An error made early in the calculations causes errors in the steps that follow.

## IFGA FORMULA

One of the most useful formulas for aerial photography calculations is the IFGA formula. Even when only one frame is required to capture your subject, the IFGA formula should be used. For example, when assigned to take aerial photographs of a new ship, you should use the IFGA formula to determine the minimum altitude or distance that is required to fit the ship into the frame. By knowing the length of the ship, the lens focal length, and the size of the negative, you can determine the distance or altitude from the ship. When the aircraft must fly at a specified altitude, you can determine the ground coverage by substituting the other variables in the IFGA formula. Refer to the training manual *Photography (Basic)*, NAVEDTRA 12700, for step-by-step application of the IFGA formula.

## AERIAL PHOTOGRAPHIC DATA COMPUTER

An aerial photographic coverage and flight planning computer, such as the Aerial Photographic

Data Computer (Type BM-38A). can assist you with many of the calculations required for mission planning. The aerial photographic data computer contains scales, indices, and information pertaining to frame and panoramic camera photography as well as radar and infrared detection mapping. This computer is a useful tool in mission planning. It can provide quick responses to a number of mission requirements (fig. 4-16).

The aerial computer is designed primarily for large-format automated camera systems. However, it is helpful in making calculations for hand-held aerial photography when 70mm film is involved (using the Bronica ETRS or Agiflite, for example). Information

that can be provided by the aerial calculator is as follows:

- Scale index
- Scale factor
- Focal length required
- Ground coverage
- Altitude

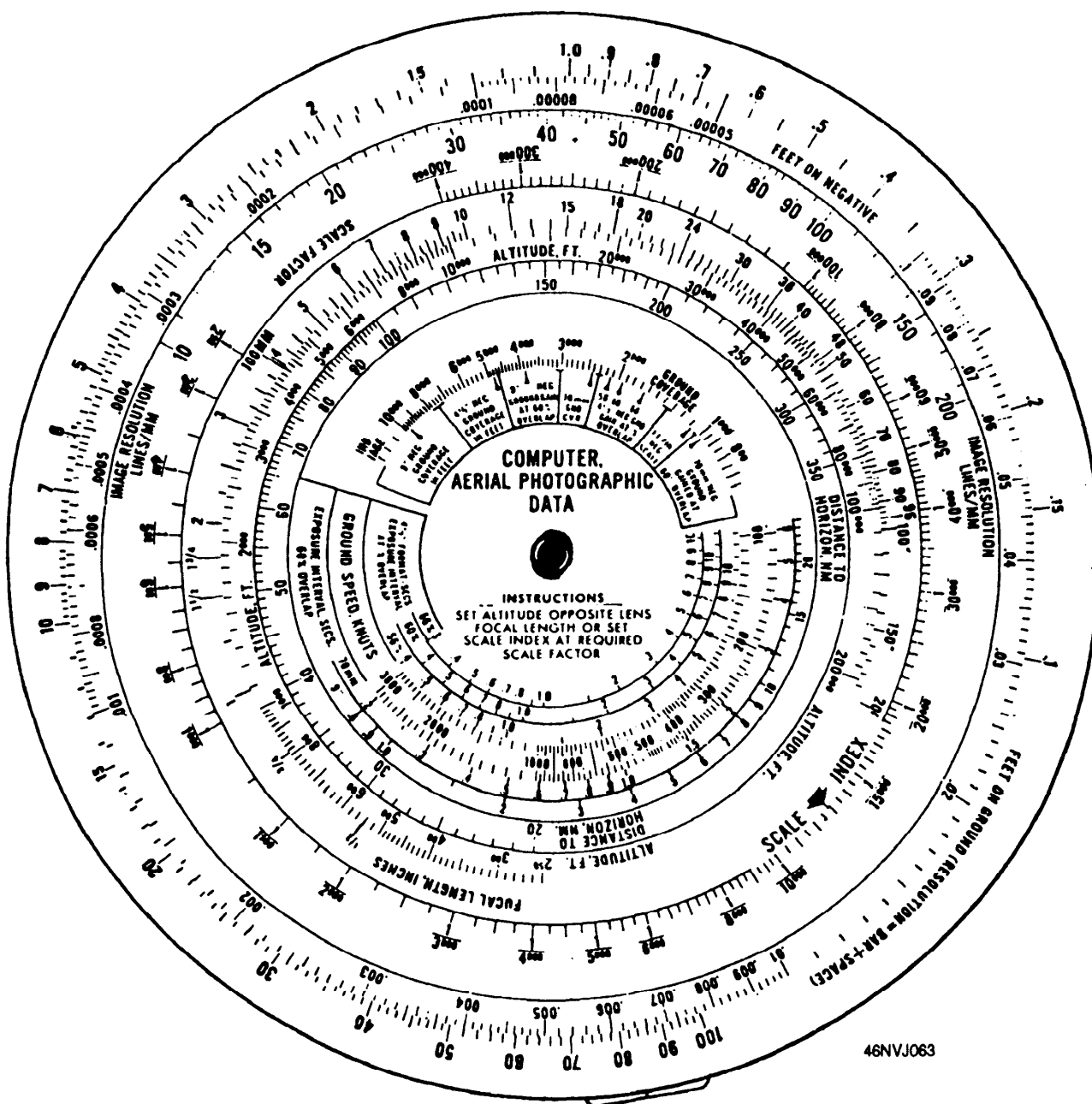

Figure 4-16.—Aerial photographic data computer (front).

- Exposure interval (in seconds) for 60-percent overlap
- Ground gained
- Ground coverage per inch of negative and exposure intervals

When you intend to use the BM-38A computer, refer to the *Photographic Computer Instruction Book*, RC-025063, for detailed instructions.

## SCALE

Usually, the area to be mapped is indicated on a chart and maximum boundaries are provided. The scale fraction of this chart, or its linear scale, provides important information. The amount of area to be covered can be determined from one of these scales.

The scale of a map is indicated as a common fraction or as a ratio. For example, the scale may be 1/10,000 or 1:10,000 on the map. In either case, the scale is read "one to ten thousand." This scale indicates that one unit of measure on the map is equal to 10,000 of the same units on the ground.

One problem in aerial mapping is locating the scale of the mosaic map. When the required scale is provided, then the altitude and focal length must be determined to get the required scale. The scale of a photographic mosaic map is calculated as follows:

S = Scale of the map

F = Focal length of the lens

A = Altitude above the ground

With F (in inches), A (in feet) must be multiplied by 12 to convert to the same unit of measurement (inches).

$$S = \frac{F}{12A}$$

Example: What is the scale of a map taken from an altitude of 5,000 feet, using a 6-inch lens.

$$S = \frac{6}{12 \times 5,000} = \frac{6}{60,000} = \frac{1}{10,000}$$

Therefore, the scale is 1/10,000. That means 1 inch on the photograph equals 10,000 inches on the ground.

## FORWARD OVERLAP

To ensure complete coverage of the area, you should take each photograph in each flight line or strip so it overlaps both the preceding photograph and the following photograph. The amount of overlap on each photograph is approximately 60 percent. Creating this overlap ensures that the strip contains no blank areas (fig. 4-17).

The overlap also serves another important function. In the construction of a mosaic map, only the central area of each print is used. Only the central area is used because the middle areas of all vertical photographs are the area of truest reproduction of terrain. (See fig. 4-18.)

In figure 4-18, the aircraft is flying over a mountain while making a series of vertical photographs. For all practical purposes, when the aircraft is directly over the mountain, a perfect reproduction of the mountain is obtained. Pictures taken before and after the one directly over the mountain show the near side of the mountain clearly, but very little, if any, of the far side. This is caused by the different camera positions in respect to the subject.

Scale is affected by this difference of camera positions. It is practically impossible to match the edges of prints when these distortions of the terrain are present. Therefore, the outer area (toward the edges of the print) is discarded and the inner 40 percent of each print is used. Another important reason for using only the center area of the prints is that stereoscopic measurement associated with either contour mapping or photographic interpretation requires the highest degree of accuracy.

Since a 60-percent overlap is created, only 40 percent of the ground-gained forward (GGF) is usable in each negative. For example, a 5- × 5-inch negative has a usable image area of 2 inches. (5.0 × 0.40 = 2.) To find the actual amount of usable GGF in each negative, multiply the ground coverage by 0.40. For example, using the IFGA formula, you have determined that the ground coverage for each negative is 9,000 feet. The usable GGF in each negative is 3,600 feet (9,000 × 0.40 = 3,600).

## SIDE LAP

The area that you are photographing for a mosaic map may be wide and cannot be photographed in one strip. The aircraft must fly a number of side-by-side strips to get complete coverage so none of the area is



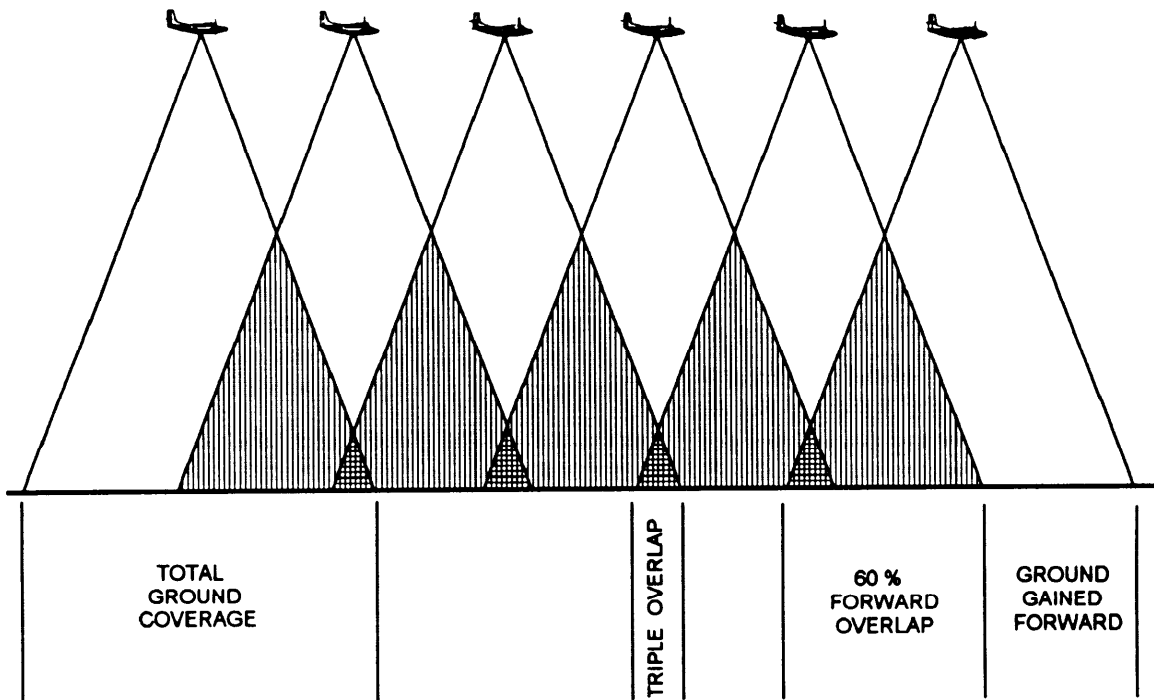

46NVJ064

Figure 417.—Forward overlap.

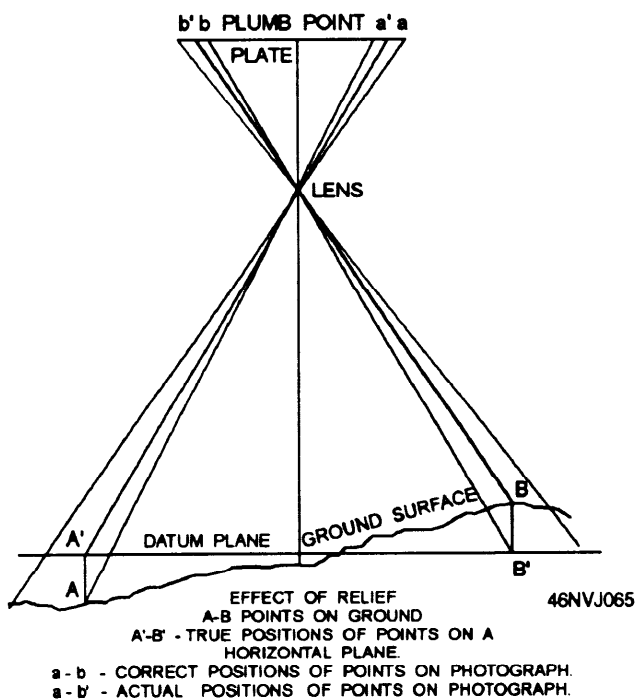

46NVJ065

Figure 4-18.—Effect on scale when photographing over rough terrain.

missed. Since only the central portion of each photograph is used in a mosaic map, each successive strip must overlap the preceding strip. This overlapping of strips is called **SIDE LAP**. Side lap for mosaic maps is usually 40 percent (fig. 4-19).

Since each flight strip is overlapped 40 percent, only 60 percent of sideways usable area remains on each negative. To find the amount of usable ground-gained sideways, multiply the ground coverage by 0.60. For example, when the ground coverage is 9,000 feet, the usable ground-gained sideways (GGS) is 5,400 feet ( $9,000 \times 0.60 = 5,400$ ).

The shorter dimension of the negative is always used for the GGF. This is to limit the number of flight lines to as few as possible. This helps to eliminate the

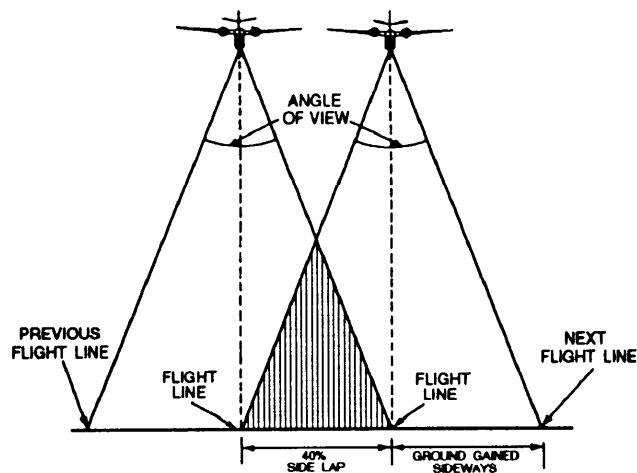

46NVJ066

Figure 419.—Side lap.

possible error in lining up each successive flight line. The longer dimension of the film is always used for the GGS.

Figure 4-20 shows the usable portion of a 9- × 9-inch negative after the GGF and GGS have been factored in.

## NUMBER OF EXPOSURES

When you are flying for mosaic mapping purposes, the flight strips are usually made along the long dimension of the area being photographed. This practice reduces the number of turns the aircraft must make to photograph the strips. For example, if the area to be photographed is 5 nautical miles east and west by 10 nautical miles north and south, the strips should be flown north and south.

To determine the number of exposures per strip, you should divide the ground-gained forward into the length of the map. When the unit of measurement is in nautical miles, you must convert it into feet (1 nmi = 6,080 ft). Therefore, if the area to be photographed is 10 nautical miles, the area when converted to feet is 60,800 (10 × 6,080).

You add four additional frames to each strip. Two additional photographs should be taken just before reaching the beginning point and two just after the ending point. These four photographs allow for possible errors in reading the beginning point and the

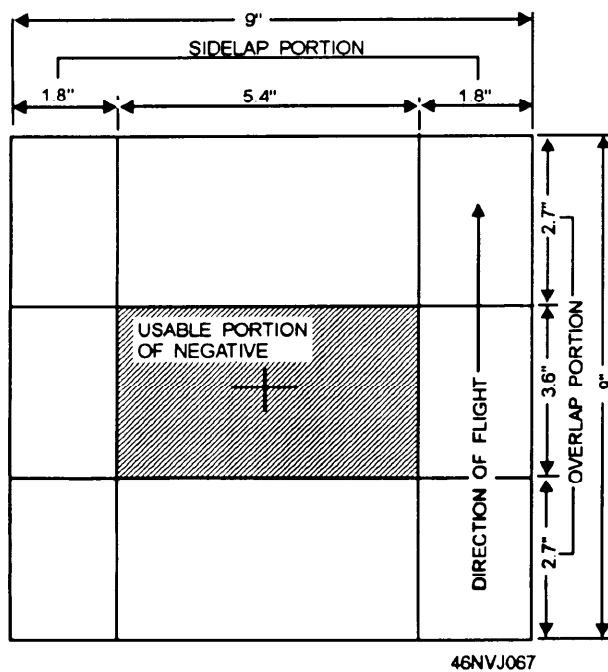

Figure 4-20.—Usable portion of a 9- × 9-inch negative.

ending point of the run on the ground (from the data shown on the flight chart).

You must first calculate the total number of flight strips required to cover the area. Next, divide the ground-gained sideways (GGS) by the total width of the area to determine the total number of strips. Always add one additional strip to your calculations. To determine the total number of photographs (frames) required for the entire mosaic mission, multiply the number of photographs required for each strip by the number of strips.

If the camera can hold enough film for the entire mission, you should have no problem. However, if the camera does not hold enough film for the entire mission, you either have to change film between strips or be prepared to make several flights.

## FLIGHT LINES

Before the mapping flight, you should plot the flight lines for each run and draw them on the flight chart with a color that is easily recognizable. Draw the first flight line along the border of the area to be photographed. The remainder of the flight lines should be evenly spaced and parallel to one another.

Figure 4-21 shows a nomograph that can be used to determine the number of flight lines required to cover the target. This nomograph is for low-altitude coverage only.

The nomograph (fig. 4-21) is used as follows:

1. Place a straightedge on the width of the area to be searched and another along the altitude to be flown.
2. Note the intersection on line  $R_1$ .
3. Place a straightedge on the point on  $R_1$  and another along the field of view of the camera lens.
4. Note the intersection on line  $R_2$ .
5. Move to  $R_3$ , keeping the same relative positions on segments  $R_1$  and  $R_2$ .
6. Place a straightedge on the point on  $R_3$  and another along the side lap required.
7. Read the number of flight paths (to the largest whole number).

To determine the distance between the plotted lines on the chart, you must change the ground-gained sideways into inches and multiply it by the scale (fraction) used on the chart. For example, if the GGS is 5,400 feet, or 64,800 inches, and the scale of the chart



converting airspeed (in knots) to feet is  $1.7 \text{ (kts)} \times 1.7 = \text{ft/sec}$ ). For example, when the airspeed is 125 knots, the ground speed, in feet, is 212.5 feet per second ( $125 \times 1.7 = 212.5$ ).

Head winds and tail winds must also be considered. When head winds are present, you should subtract the head wind from the airspeed. Tail winds should be added to the airspeed. For example, when the aircraft is flying north at 125 knots and the wind is blowing from the north at 10 mph, then the corrected airspeed is 115 knots ( $125 - 10 = 115$ ). When the aircraft is flying south, then the corrected airspeed is 135 knots ( $125 + 10 = 135$ ). The corrected airspeed must be used to find the ground speed, in feet.

For the time interval between exposures, the following formula should be used:

$$T = \frac{D}{S}$$

Where

T = Time in seconds

D = Ground-gained forward

S = Ground speed in feet per second

NOTE: When the interval between exposures can be accomplished in full seconds only, the tenths of a second should be dropped. By doing so, slightly more than the required 60-percent forward overlap is provided. This can be advantageous.

### SCALE OF THE FINISHED MOSAIC MAP

The scale of the finished mosaic map is determined by using the following formula:

$$S = \frac{F}{12A}$$

Where

S = Scale

F = Lens focal length

A = Altitude

The answer derived by using this formula gives a representative fraction (RF) in like-units. Notice that you must convert the altitude to inches, since the lens focal length is normally in inches. For example, you

used a 10-inch focal-length lens for a mapping mission flown at 5,000 feet. You can determine the scale of the finished mosaic as follows:

$$S = \frac{10}{12 \times 5,000}$$

$$S = \frac{1}{6,000}$$

The scale of the finished mosaic is 1/6,000 (1:6,000).

To reinforce the mission planning procedures, you can use the following example:

You are assigned to assist in the mission calculations required for a recon mapping mission. You are briefed on the mission and the following information is provided:

Area to be mapped is 10 nautical miles east and west by 20 nautical miles north and south.

Forward overlap required is 60 percent.

Side lap required is 40 percent.

Lens focal length is 12 inches.

Negative size is 9 × 9 inches.

True airspeed of aircraft is 140 knots.

The wind is from the north at 15 knots.

The scale of the chart used to plan and fly the mission is 1/50,000 (1:50,000).

The required scale is 1/12,000 (1:12,000).

A graphic scale representing 3,000 feet is required on the printed mosaic map.

**1. Determine the altitude.** The first step in this problem is to determine the altitude at which the aircraft must fly to obtain the required scale of 1/12,000. The IFGA formula used to determine the altitude is as follows:

$$\frac{I}{F} = \frac{G}{A} \text{ or } A = \frac{FG}{I}$$

Since G (ground coverage) is not known, you must substitute the required scale (1/12,000) for it. At a required scale of 1/12,000, each unit of I (on the film plane) records 12,000 units of G. Since A is measured in feet, you must divide your answer by 12 to get the units in feet.

$$A = \frac{12 \times 12,000}{1} = \frac{144,000}{1} = 144,000$$

Divide by 12 to get altitude units in feet

$$144,000/12 = 12,000 \text{ feet}$$

2. **Determine the ground coverage.** Now that you know the altitude at which the mission must be flown to obtain a scale of 1/12,000, you can determine the amount of ground coverage on each frame. Again, this information can be determined using the IFGA formula. Remember that the forward overlap required is 60 percent. The remaining 40 percent of the 9-inch negative is usable imagery for GGF. You must first find the size of the usable portion of the negative for GGF. This is accomplished as follows:

$$0.40 \times 9 = 3.6 \text{ inches of useable image area for GGF}$$

$$\frac{I}{F} = \frac{G}{A} \text{ so } G = \frac{IA}{F}$$

$$G = 3.6 \times \frac{12,000}{12} = 3,600 \text{ feet}$$

The amount of side lap required is 40 percent. This leaves only 60 percent of the useable negative image area for GGS. You determine the usable portion of the negative for GGS as follows:

$$0.60 \times 9 = 5.4 \text{ inches of usable image area for GGS}$$

$$G = 5.4 \times \frac{12,000}{12} = 5,400 \text{ feet}$$

3. **Determine the total number of frames required.** Next, you need to determine the total number of frames required to complete the mission. You know that the area to be mapped is 10 nautical miles east and west by 20 nautical miles north and south. Therefore, the strips will be flown north and south.

The number of exposures per strip is determined by dividing the GGF into the length of the map. First convert nautical miles into feet (1 nmi = 6,080 ft) and multiply by 20 (length of area to be mapped).

$$6,080 \times 20 = 121,600 \text{ feet}$$

Next, divide by the GGF as follows: 121,600/3600 = 33.77 or 34 frames per strip. Remember to add four more frames. This totals 38 frames for each strip.

Now you must find the number of strips required. The area to be mapped is 10 nautical miles long. Calculate the number of strips as follows:

$$10 \text{ (nautical miles)} \times 6,080 \text{ (feet per nautical mile)} = 60,800 \text{ feet}$$

$$60,800/5400 \text{ (GGS)} = 11.25 \text{ or } 12 \text{ flight strips}$$

Remember to add one strip, so a total of 13 flight strips is required.

To determine the total frames required for the mapping mission, you must multiply the number of frames required for GGF by the number of flight strips required as follows:

$$13 \times 38 = 494 \text{ frames}$$

4. **Draw flight lines on the chart.** Your next step is to draw the flight lines on the chart used to fly the mission. The scale of this chart is 1/50,000.

To determine the distance between the plotted lines on the chart, you must convert the GGS into inches, and then multiply the GGS (in inches) by the scale of the chart as follows:

$$5,400 \text{ (feet)} \times 12 = 64,800 \text{ (inches)} \times 1/50,000 = 1.29 \text{ inches}$$

The distance between flight lines on the chart is 1.29 inches apart. A multi-finger divider should be used to draw these lines.

#### 5. Determine the time interval between exposures.

To determine the exposure interval, first convert the aircraft speed to feet per second. The true aircraft speed is operating at 140 knots, but there is a wind of 15 knots coming from the north. Since the aircraft will be flying in a north and south direction, the wind factor must be taken into consideration. At this time determine the corrected airspeed in knots, then determine the airspeed in feet per second as follows:

##### 1. Corrected airspeed.

###### a. Aircraft flying toward the north

Corrected airspeed (140 knots - 15 knots = 125 knots)

###### b. Aircraft flying toward the south

Corrected airspeed (140 knots + 15 knots = 155 knots)

2. To determine aircraft speed in feet per second, you must multiply the corrected airspeed by the conversion factor of 1.7.

a. Aircraft flying toward the north = 212.5 feet per second

b. Aircraft flying toward the south = 263.5 feet per second

To calculate the exposure interval, you must use the following formula:

$$T = \frac{D}{S}$$

T = Time in seconds

D = GGF (distance)

S = Ground speed in feet per second

By substituting the values, you can determine the exposure intervals as follows:

$$T = \frac{3600}{212.5} \text{ or } 16.9 \text{ seconds for aircraft flying toward the north}$$

$$T = \frac{3600}{263.5} \text{ or } 13.6 \text{ seconds for aircraft flying toward the south}$$

6. Graphic scale. To determine what graphic scale represents 3,000 feet, you should use the IFGA formula as follows:

$$I = \frac{FG}{A}$$

$$I = \frac{12 \times 3000}{12,000} = 3 \text{ inches}$$

Therefore, 3 inches on the map represents 3,000 feet on the ground.

## SAFETY

Whether you take photographs from the rear seat of a jet or from the open door of a helicopter, you must be checked out and become thoroughly familiar with the necessary safety equipment and applicable safety procedures. Before the flight, you should arrive at the aircraft or briefing area in sufficient time for the preflight brief. The main responsibility of the pilot is to fly you and your photographic equipment to the target, put the aircraft in position for photographing, and return to the base safely. The pilot knows the limitations of the aircraft and what procedures to follow in an emergency. Ask the pilot about emergency plans and FOLLOW this advice.

Aircrew personal protective equipment plays an essential role in the safety and survival of people flying in Navy aircraft. The equipment is designed to protect them from the elements and to provide necessary comfort for efficient mission performance. Its primary function is to protect a crew member against the environmental hazards. Different combinations of clothing and equipment are used to provide overall protection and comfort to an air crew member under various flight, emergency, and environmental conditions.

Aircrew protective equipment is designed to meet the stress of a combat environment and to provide fire protection and camouflage with various other escape and evasion design features. Emphasis is placed on developing materials and clothing assemblies to enhance an individual's chance of survival and to minimize injuries in an aircraft accident.

Before flying in an aircraft, you must obtain the proper personal protective equipment specified for the type of aircraft in which you will be flying. The squadron-, intermediate-, or depot-level maintenance activities can provide you with the required equipment. **YOU MUST NOT FLY WITHOUT THE PROPER EQUIPMENT** and the equipment must fit you correctly. **Your life may depend on it.**

## WARNING

Unauthorized modification or deviation from prescribed life support and survival equipment by individual crew members could create safety hazards. NATOPS *General Flight and Operating Instructions*, OPNAVINST 3710.7, specifies minimum requirements for such equipment and is supplemented by the naval air training and operating procedures standardization program for each specific model of aircraft. Peculiar configurations or modifications to life support and survival equipment are not authorized. Aircrew Survival Equipmentman (PR) who issue and maintain this equipment have no authority or responsibility to perform these actions, so do not ask them to do so.

During takeoffs and landings, your photo gear must be made secure within the aircraft, so it does not become a hazard. When your equipment consists of small items, such as a hand-held camera and exposure meter, hold them in your lap. Tie-down straps or passenger seat belts provide a means of securing bulky equipment. If you cannot find the means to secure your equipment on board the aircraft, request assistance from the plane captain or another crew member. During flights in a helicopter, keep all photo gear secure. This will prevent it from falling out an open door. It is a violation of federal law to drop objects from aircraft while in flight. When working in or leaning out of an open door or window in an aircraft, you should use a neck strap or wrist strap to secure your camera and other items.

During takeoff and landing, you should occupy a designated passenger seat. Once airborne and before you approach an open door, you must have a properly adjusted, securely anchored crew member's safety harness around your waist. The crew member's safety harness should be adjusted **BEFORE TAKEOFF**. Attach the snap hook of the harness to a tie-down ring on the deck of the aircraft. The tie-down ring should be about 3 to 4 feet from the open door. Never attach the snap hook to pipes, tubes, cables, or similar items. Place the harness around your waist and fasten the latch and link assembly. Pull the adjustment straps of the waist portion of the harness, so it fits snugly around your waist. Now adjust the length of the safety strap, so you can sit in the open doorway and still lean forward about 1 foot.

### **PREFLIGHT AND POSTFLIGHT INSPECTIONS**

As an aerial photographer shooting hand-held images, your preflight inspection is concentrated primarily on your photographic equipment and your personal protective equipment.

You know what camera and equipment checks to make before every photo assignment. These equipment checks are particularly important in aerial work. In aerial work, more people are directly involved with the mission. As a minimum, there is the pilot, copilot, plane captain, and yourself. With the great expense and time involved in flying Navy aircraft, **IT IS ESSENTIAL** that you have your equipment functioning correctly. Equipment breakdowns may occur during a flight; however, it is your responsibility to be sure that the necessary equipment and materials for the mission are present and working properly.

Your personal protective equipment must be checked before each flight—your life may depend on it. Because of the many types and applications of personal flight safety gear available, you must get a professional check on the use of your equipment and an inspection as to size and fit of your equipment from a knowledgeable Aircrew Survival Equipmentman (PR).

The aircraft preflight inspection is the responsibility of the pilot. This is not to say, however, that you should not check those areas of the aircraft in which you will be directly involved during the flight. For example, does the door, window, or hatch open and close easily? Is the intercom system working? What about the tie-down ring to which you will hook your safety harness? Is it safe? Has the ejection seat safety

pin been removed? Is the canopy clean? Is the oxygen system working?

Your postflight duties after a hand-held aerial mission include removing all your equipment from the plane and "housekeeping," such as straightening up seat belts and securing the intercom and oxygen systems. You and the pilot should also discuss the mission—how did it go? What went right? What went wrong? What could be done better next time to make the flight go better?

### **COMMUNICATIONS**

The pilot must know your intentions. This means you must communicate with him before and during the flight. Remember, the pilot is not looking through the camera viewfinder. The pilot's view of the target, providing he can see it, is different from yours. You must direct the pilot into positioning the aircraft for the photography.

The noise level during the flight is high and voice communications are difficult at best, particularly in helicopters. Establishing a few hand signals with the pilot beforehand may prove very helpful during the mission—hand signals that indicate "there is the target," "move right," "left," "up," "down," "turn right," "left," and "steady, I am shooting" (fig. 4-23). In the air, a pilot has a better understanding of your needs with prearranged signals as compared to makeshift signals which may fail to be communicated correctly.

Communications between you and the pilot are essential. During the photo part of the flight, you should be in constant communication with the pilot. To get the best photographs, you must communicate to the pilot about positioning of the aircraft. Tell the pilot when the aircraft is too close or too far from the target and when the altitude of the aircraft is correct or not correct. If camera problems develop, let the pilot know. Long periods of silence cause the pilot to wonder what is happening in the photography area and whether the mission is going as planned. This is no time to be bashful or intimidated. Do not be concerned about talking too much.

### **COMPOSITION**

Since hand-held verticals are made with the camera pointed straight down at the ground, photographic composition for vertical photography is straightforward. The person requesting the work tells you what to show in the picture. Then it is primarily a

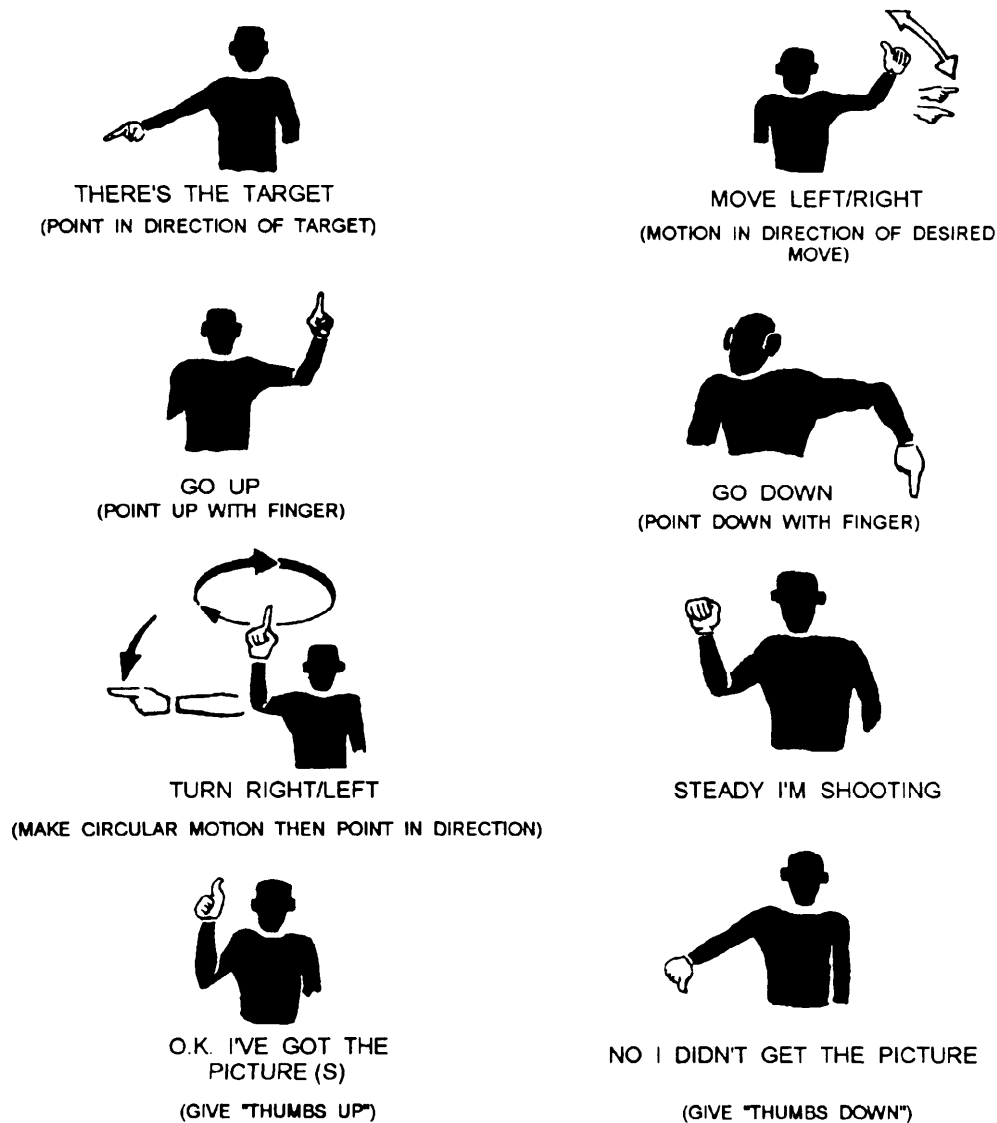

46NVJ070

Figure 4-23.—Hand signals.

matter of including all of the subject or ground area in the picture.

Hand-held oblique aerial photography often provides a unique communication capability—an overall view that cannot be obtained from the ground in a single photograph or even in several photographs. Generally, aerial oblique photos show relationships in size and spacing between objects better than ground views. The angle of view is unusual and attention getting, partly because people are unaccustomed to seeing subjects from above. As with composition for any type of photography, when you compose an aerial photograph, you should consider all the aspects of good composition—image size, subject placement within the picture area, balance, camera angle, lighting, and timing (when to fire the shutter). The target and purpose of the

pictures are the guides you should use for determining proper composition. Good aerial photographic composition is harder to achieve than ground photographic composition. In aerial work you are in a moving aircraft and do not have the time necessary to compose a picture in the viewfinder. You must compose the picture in your mind as you observe the target from the aircraft during the approach. You cannot move the subject around or change the direction from which the light is coming. Your two primary tools in aerial composition are camera viewpoint and timing. You must shoot your pictures at the correct instant to ensure the area and objects of interest are in the picture. Also, in a sequence of exposures (a strip), each photograph must have the correct relationship to the



others in the sequence. In other words, you cannot have any "holidays" or missed areas within the strip.

You may have some control over what time of day to fly the mission. If so, use the sun to best advantage for the most desirable lighting. When the sun is at an angle that causes shadows to fall across the subject and obscure some important detail, you may ask to fly the mission at a different time of day or even on an overcast day. Whenever possible, shoot obliques with the sun falling on the scene from about a 45 degree angle. This provides proper shadows and creates a feeling of depth. With the sun directly in back of the camera, the picture appears flat. With the sun directly in front of the camera, the shadows may obscure detail and lens flare can result. Shadows play an important role in picture balance by creating an illusion of depth; they also aid in determining the physical characteristics of ground areas. The size of objects in a photograph can be determined by the length and width of their shadows. You can obtain the desired shadow effect by ensuring the pilot places the aircraft properly in relation to the target. Teamwork between the pilot and the photographer is another contributing factor to good aerial composition. Remember, both the photographer and pilot are "handling" the camera, but you are responsible for getting the images.

A minimum image size may be required to locate or identify large objects in a photograph. Small objects and great detail require a large image size. You can obtain the proper image size in your photographs by selecting the proper altitude of the aircraft and the lens focal length of the camera.

Subject placement within the image area is also an important consideration. Because you are in the air and have a "bird's eye" view of the subject does not mean you have a good camera viewpoint. Is a tall building or grove of trees hiding some important subject detail? If so, direct the pilot to move the aircraft into position for a better viewpoint. A good rule for composing low obliques is to divide the camera viewfinder into three sections: the first section at the bottom of the viewfinder is foreground, the center third of the picture is target area, and the top third is background. For high obliques, divide the camera viewfinder into four sections: the bottom section of the viewfinder is filled with foreground, the next section above it is target area, the third section is background, and the last quarter is sky. Subject balance should also be considered while keeping in mind the three or four primary divisions or areas of low and high obliques, respectively. Study the view during your approach to the target.

The horizon is another factor for consideration in oblique work. The horizon or, in the case of a low oblique, the imaginary horizon should be straight in your pictures. A real horizon that is crooked, even in a high-oblique picture, does not appear natural; it is distracting and does not reflect the work expected of a professional aerial photographer. When making obliques, you should hold the camera so the horizon is straight. This is easy to do in a high oblique because the horizon is included in the picture and can be seen while the picture is taken. When making a low oblique, hold the camera as though a high oblique was being made, straighten the horizon, then lower the camera carefully to the correct angle for the low oblique. A horizon that is crooked is often the result when a photographer concentrates on the subject alone and does not compose the image in the viewfinder.

The camera may be tilted in some instances; for example, when two points of interest must be included in one exposure. If you cannot do this by holding the camera level, then turn the camera slightly at an angle; the two points can sometimes be included in the diagonal of the picture area (fig. 4-24).



Figure 4-24.—Tilting the camera to include subject area.



Figure 4-25.—Missiles used to frame the F-14 Tomcat.

## SHOOTING TECHNIQUES

Your camera equipment should be prepared for the aerial assignment well before you approach the target area. As you approach the target area, you should recheck your equipment and have it ready for the first exposure. Check the altitude, speed, and direction of the aircraft. Check to see that you have the right camera angle for the best picture. Using voice communications or prearranged hand signals, direct the pilot to fly the aircraft into the best picture-taking position. Directing the necessary turns enables you to get the aircraft into proper position without a lot of explanation to the pilot.

Whenever possible, decide on the altitude you want to fly before takeoff. When the subject requires photography from different altitudes, start at the highest level and work your way down. Thus time en route to the target can be used for climbing. Altitude can be reduced much faster than it can be gained.

When an aircraft is turning to take up another heading, the wing or rotor blades may obscure the subject. Ask the pilot for precise, steep turns; this

technique will blind you to the target for only a few seconds.

Do not shoot photographs when the aircraft is turning. This causes your negatives to be reasonably sharp in the center, but decreasingly sharp toward the edges. High-shutter speeds may not correct this fault.

One of the principal problems in hand-held aerial photography is camera movement during exposure. This basic problem is magnified significantly where aircraft vibration and relative target movement are also present. Best picture results can be achieved when the pilot reduces the throttle. This reduces aircraft vibration and minimizes image movement. Image blurring, caused by camera movement, can be reduced by using a faster shutter speed. You must handle the camera carefully to reduce the effects of aircraft vibration transmitted on the camera. You should firmly grip the camera with your elbows held firmly to your sides. No part of the camera or your upper body should touch the aircraft while exposing film. At the instant of exposure, you should hold your breath. The shutter should be depressed in a steady, smooth manner. You



**Figure 4-26.—Air-to-air photograph taken through a closed canopy.**

may also be able to minimize image motion by panning the subject with the camera. When you are flying low, the target may "shoot" past you so fast that the shutter speed cannot "stop" it. This results in a photograph that is not sharp. To prevent this, "follow the target" (pan) with your camera. The pan must be continuous and smooth. Move the camera in the direction opposite to the direction of flight, keeping the lens fixed at some point on the target. With this technique, the image on the film does not move as much as it would if the camera were held still.

With a hand-held camera, you have freedom of movement; however, the view of the camera is limited by the structure of the aircraft. Do not include the tip of a wing or any other part of the aircraft in your photographs, unless you do it intentionally (fig. 4-25). The views of the target are best when the aircraft is approaching or leaving the target and the target is off to one side. At a level altitude, in fixed-wing aircraft, you may have difficulty excluding the tip of the wing from the view of the camera. You can tell the pilot to bank the aircraft; that is, raise the wing of a high-wing aircraft on the side from which you are shooting. You can also

tell the pilot to lower the wing of a low-wing aircraft when the aircraft passes the target. This maneuver should lift or drop the wing of the aircraft out of the picture area. Another flight maneuver for getting the wing of the aircraft out of the picture is to have the pilot crab the plane. After the plane is crabbed, it is on a different heading than the original direction of flight; thus the wing is outside the area of the photograph.

When you are shooting photographs from a helicopter, have the pilot fly at a level altitude or bank when the aircraft passes the target, so the rotor blades are raised from the area of the photograph. This minimizes the chance of rotor blades appearing in the photograph.

The slipstream outside an aircraft can be very strong, so when you are taking photographs through an open window or door, be sure you have a good grip on the camera and all loose objects, and camera parts are well-protected and secured.

In some aircraft, you must take photographs through a canopy or closed window (fig. 4-26). The plexiglass, or glass, can cause a slight shift in image

focus. This shift in focus may be reduced by stopping down the lens; however, this is not always possible because you may need fast shutter speeds. The best method of shooting photographs through a window is to take the picture with the optical axis of the lens perpendicular to the surface of the window. The lens should be as close as possible to the surface of the window without touching it. Although this method allows you to take only one or two photos during each pass of the target, the quality and definition of the image is better. When shooting photographs with an SLR camera through a window or canopy, you will find it helpful to make a foam rubber "doughnut" about 2 or 3 inches thick. This foam rubber shield should be taped to the camera using surgical tape because it sticks well and can be removed without leaving a gummy residue. After attaching the foam rubber shield to the camera, you should place it against the aircraft window to block internal reflections from that part of the window that the camera "sees." The shield also absorbs vibrations from the window.

Most of your hand-held aerial work, both oblique and vertical, consists of single shots; however, you may have to fly oblique and vertical strips that require overlapping photographs. The camera-to-scene distance must remain constant while you are shooting the strip. Changes in distance cause the image size to change and make matching the adjacent exposures impossible. You should make the exposures at regularly spaced intervals. You can determine the time interval visually between the exposures for a strip. Before the flight, mark your viewfinder to show the distance an object must move in the viewfinder to move the image 40 percent of the width of the film. During the flight, make the first exposure, hold steady, and make the second exposure after some point in the scene has moved the distance marked on the viewfinder. The marks are the same for any aircraft speed or altitude.

When you are not using an SLR camera, change the marks on the viewfinder if you change either the film format or the focal length of the lens.

Hand-held vertical photography is easiest from helicopters. You can lean out from your sitting position on the floor or from a passenger seat and hold the camera with the proper attitude for taking verticals. You should hold the camera firmly in your hands, keeping your torso relaxed so your arms will act as vibration dampers. Using this method, you can take vertical aerials that are incredibly sharp because of the maneuverability of the helicopter, its capability for slow flight, and the possibility for both the pilot and the

photographer to see the target. Because of these features, accurate vertical photography is easier from helicopters than from fixed-wing aircraft.

Most air-to-air photography you shoot will be of other aircraft. The purpose is to produce display and public affairs (PAO) photographs. You may also be assigned to take air-to-air photography for research and testing purposes. When shooting air-to-air photographs, you should maintain voice communication with both the pilot flying your aircraft as well as the pilot(s) of the aircraft you are photographing. This provides an opportunity for you to direct all the aircraft involved into position for photographs.

Generally speaking, the best air-to-air photographs are made from slightly above, to the side, and slightly forward of the plane being photographed; however, you should try other views, such as from below or slightly aft of the subject aircraft. A longer than normal focal-length lens (80mm or greater for a 35mm camera) should be used when you are photographing only one or two aircraft at a time. Longer focal-length lenses prevent distortion that results from using a normal or short lens. With a normal or short lens, the wings that stick out from the fuselage of the target plane and the long nose or tail section appear distorted when you photograph them from close range. When shooting formations of three or more aircraft, you should use a normal focal-length lens because you are farther from the subjects and distortion is not a problem. For a head-on view use a long focal-length lens and have the pilot fly the aircraft you are in across and above or below the projected flight path of the plane being photographed. Of course, each of the pilots need plenty of room to avoid a mid-air collision. A better and safer way to get a head-on shot is to fly in front of the plane being photographed, in the same direction, and at the same speed. You can take this shot from the open ramp of an aircraft, such as a C-130 or CH-53. In aircraft such as these, you can stand at the edge of the open ramp; ensure that you are secured properly with a safety harness.

The aircraft you are photographing does not always have to fly straight and level. Good, interesting pictures can be taken while aircraft are maneuvering, such as in a long, slow turn or in a bank. When the underside of the fuselage must be shown, request the pilot of the target aircraft to roll the plane, so the sun shines on the underside of the aircraft. For this shot, the plane containing the photographer should fly in a bank above the subject plane. This maneuver provides you with a

camera angle looking down on the plane to be photographed. When shadows are not a problem and enough light is reflected on the fuselage of the aircraft being photographed, the plane with the photographer can fly under the other aircraft and take photographs while it is in straight and level flight.

When shooting pictures of aircraft formations, you should be sure the spacing between them, as seen by the camera, is uniform. Navy pilots are among the best in the world. They can fly their aircraft in tight formations with near perfect spacing between them; however this may not be perfect as the camera "sees" it. Remember, what the camera "sees" is the way the picture will look (fig. 4-27).

The pilots of the aircraft you are photographing will probably look at the camera while you are taking their picture. Go ahead and let them—for one shot. Then tell them, "I have your picture, and I'll be sure you get a copy of it; but for the rest of the mission, please do not look at the camera." When the pilot is looking into the

camera, it looks unnatural and distracts from the main subject—the aircraft.

## MARITIME SURVEILLANCE PHOTOGRAPHY

Maritime surveillance data gathering for intelligence purposes is assisted by photographic methods; that is, high-quality pictures to provide permanent records so that detailed interpretation of the collected data can be made. A camera can record full details of the target instantly. Photographs should be made of all maritime targets worthy of observation including surface ships (war and cargo) and submarines. Air reconnaissance photographs of surface and subsurface targets made from fixed-wing aircraft and helicopters add greatly to the complete intelligence data on enemy or potential enemy shipping. It is often the duty of the Photographer's Mates to obtain this type of photography by using a hand-held camera.



*LT(jr) Steve Davis*



*PH3 Terry Beall*



*CDR John Leenhouts*



*CDR John Leenhouts*

Figure 4-27.—Air-to air photographs.

The value of maritime surveillance photography can be enhanced if you use correct photographic composition, appropriate field of view, and proper rigging patterns (fig. 4-28). The best photographic composition of a ship cannot always be obtained by shooting horizontal views. In maritime surveillance photography, it is important for you to ensure the target is recorded as large as possible on film.

Four basic rigging patterns for maritime surveillance photography are in use today. They are the Special Interest Rig, the Quick Rig, the Normal Standard Rig, and the Full Rig. Proper rigging of the target provides maximum intelligence data from the photographs. To better understand the purpose of each rig, you must know what each view (or point) of the rig is designed to achieve. The BOW QUARTER view is useful in determining forward deck cargo-handling equipment, electronic arrays, and vessel identification. The BEAM view provides the length of the target plus the stack and antenna height. The STERN QUARTER and the STERN views are used to determine cargo and electronic arrays on the aft section of the vessel. The VERTICAL view is valuable in locating electronic arrays, in determining full-deck cargo, and for measurement purposes.

The SPECIAL INTEREST RIG is required when a particular vessel is photographed for the first time, or there are specific areas of interest on a particular vessel. Before this type of mission, a special briefing must be conducted to determine what specific rigs should be flown to satisfy mission requirements. The QUICK RIG is used for routine photographic documentation of a contact (vessel) observed while on patrol. The quick rig consists of the bow quarter, beam, and stern quarter views of a vessel. The NORMAL STANDARD RIG, commonly referred to as the FIVE POINT RIG, consists of the bow quarter, beam, stern quarter, stem, and vertical views of a vessel. This rig is used to provide a more detailed representation of a vessel. The FULL RIG, or NINE POINT RIG, is required when enemy or potential enemy vessels are being photographed. This rig provides complete coverage for all the areas of interest. The best approach for rigging most of the aircraft used in maritime surveillance photography is from the bow of the target.

Although the previous discussion concerns obtaining intelligence photography, the very same procedures are useful in shooting pictures of ships and submarines for PAO release and for display prints. By using these procedures, you can "kill two birds with one stone." You get the display pictures, and it serves as a training mission in maritime surveillance photography for both you and the pilot.

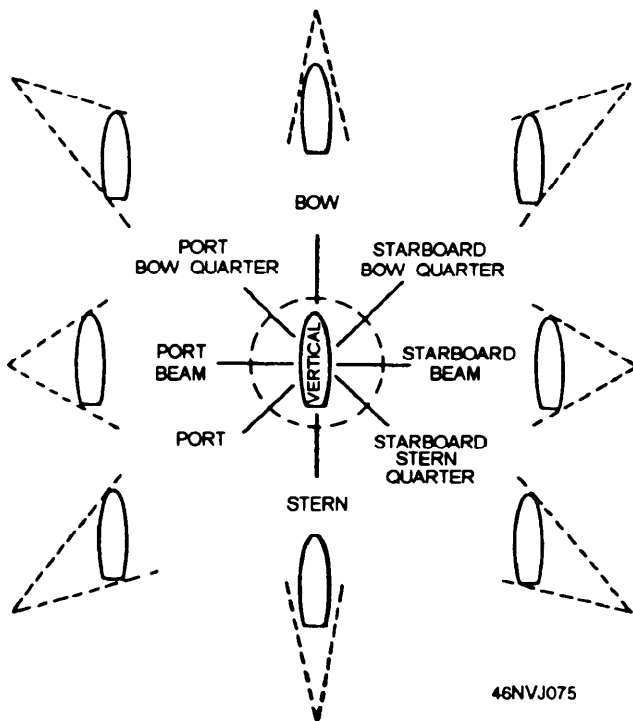

Figure 4-28.—Maritime surveillance photography rigging patterns.

## MOTION-MEDIA PHOTOGRAPHY FROM THE AIR

In most cases, the techniques and exposure recommendations for still aerial photography apply to shooting motion-media photography from the air. However, there are a few differences. As a general rule, frames-per-second (fps) rates that are above normal should be used for motion pictures; that is, unless you have a specific requirement to film at the "real time" rate. Just as in still photography, the image quality of aerial motion media suffers from image motion on the recording. Motion-media scenes taken from aircraft always appear much faster when viewed than when they were being recorded originally. Aerial movies when shown at normal frame rates are disturbing to the viewer. There is no hard-and-fast rule about what frame rate is appropriate for viewing; there are several factors that play a significant role, such as speed and altitude of the aircraft. A general rule of thumb is to use about one and one half or twice the normal frame rate: 32 to 48 frames per second for 16mm and 24 to 36 frames per

second for super 8. For video work, the shutter speed should be set to 1/500 second or higher.

When shooting, you must keep the camera steady, keep your upper body and the camera from making contact with the aircraft, and make any necessary pans slowly and smoothly. Fixed-wing aircraft should make a gentle arc around the subject (into the wind) at moderate speed and with a few degrees of flap. On occasion, you may be filming a fast-moving activity on the ground. Again, the technique of flying an arc around the subject is often best because you are moving faster than the action below. You need a zoom lens or a camera with a turret and different focal-length lenses to change your view of the subject. However, avoid the temptation to overuse the zooming technique while shooting. Instead, change the focal length between scenes to obtain variety and interest in your images.

The problem of maintaining a steady image is greatly magnified when you must shoot with a long focal-length lens. In these circumstances, you should use a gyrostabilizer, if it is available. A gyrostabilizer is an aerial camera mount that uses a gyroscope to maintain camera stability.

## **PROCESSING AERIAL FILM**

Because of the cost involved, the importance or urgency of the images, and the situations involved in obtaining aerial images, it is extremely important to process images under optimum conditions and the images be free of physical or chemical defects.

Film processors must be checked and verified according to the quality-assurance procedures established by your imaging facility. Processing solutions, machine speeds, and temperatures must be checked with sensitometric tests and verified to comply with the processing instructions indicated on the mission planning form. Each aerial film-processing work center should have an established family of curves for each type of film used. Camera exposure settings are based on the expected response (speed) of a particular emulsion developed to a specified gamma in a particular type of chemistry at a specified temperature. If you deviate from the planned processing parameters, it affects the degree of development of the imagery and may render the imagery unusable. The photo processing crew is the key to success or failure of the entire reconnaissance mission.

## **MISSION PLANNING FORM**

The mission planning form (fig. 4-29) is used with TARPS. It is a tool of communication between the reconnaissance coordinator, squadron maintenance personnel, and imaging facility personnel. The form is divided into three basic areas of responsibility: mission data, maintenance, and processing data. The section of primary interest to you is the mission data and processing data.

### **Mission Data Section**

After reconnaissance mission requirements are established, the sensor or group of sensors best suited to fulfill the requirements are selected. The mission planner should enter the sensors, the appropriate sensor IDS, the types of film, and the processing gamma of the types of film. The mission planning form should then be forwarded to the aircraft maintenance personnel and to the photo personnel. This data may then be used to equip the aircraft for the mission. The data also allows the imaging facility to make preparations for processing the film.

### **Maintenance Section**

After receiving the mission planning form, the line maintenance personnel begin preparing the sensors, associated equipment, and aircraft for the mission. As various tasks are completed, the Maintenance section of the form is completed by maintenance personnel. When the aircraft returns from the mission, the film is removed, and the appropriate postflight counter settings are entered in the Maintenance section of the form by maintenance personnel. The film, along with the mission planning form, is then delivered to the imaging facility for processing.

### **Processing Data Section**

The film is processed according to the information entered in the Mission Data section of the form. The film processing results are entered in the Processing Data section of the form. The film is then evaluated for image quality and appropriate entries are also made in the Processing Data section of the form. Finally, the completed mission planning form is returned to the reconnaissance coordinator for purposes of debriefing and filing.

# MISSION PLANNING FORM

PHOTO LAB JOB CONTROL INFO

CLASSIFICATION 01	PROJECT NUMBER 02      05	UNIT 07	NUMBER 08	MEDIA 14	O R 18
REQUESTER SUPPLIED INFORMATION ORGANIZATION		NAME OF REQUESTER		UIC 17	CUSTOMER JOB NUMBER 22
PHONE	AUTOVON PREFIX	RECEIVED	DATE 45      47      50		
PILOT	RIO	EVENT	ETD	A C	POD
DATE (DAY MONTH YEAR)		MISSION	SQUADRON	DET	SORTIE

MISSION DATA

SENSOR DATA	FRAME CAMERA	PAN CAMERA	IR SENSOR	
FILM TYPE				
FILM LOAD				
S/C				
FILTER				
DDS EXP/PW	1-2-3-4-5	10-15-20-25	1-2-3-4-5	
GAMMA				

REQUIREMENTS SET BY

DAY-TIME

MAINTENANCE

CAMERA NO.				
MAGAZINE NO.				
SUPPLY NO.				
TAKE UP NO.				
EMULSION/TYPE				
PRECOUNT				
POSTCOUNT				

LAB DELIVERY BY

DAY-TIME

I.D. NUMBER

PROCESSING DATA

PROCESSOR NO				
CALIBRATED FPM				
TEMP				
DEVELOPED GAMMA				
QUALITY OF FILM				
FOOTAGE				
DAY/TIME				
PROCESSED BY				

FILM PICKED UP BY

DAY-TIME

REMARKS

46NVJ076

Figure 4-29.—Mission planning form



## PROCESS EVALUATION

Pre-mission validation must be performed on the processing system before attempting to process mission material. These tasks must be performed so the system is operating within acceptable, established limits for that particular mission. Six tasks must be performed as follows:

- The processing machine must be checked and verified to be operating correctly. This includes solution levels, transport system, temperature, replenishment rates, and water supply.

- The measuring equipment, such as densitometers and pH meters, must be calibrated properly to ensure valid, reliable data.

- The processing, printing, and support equipment must be checked and verified to be operating properly.

The composition of chemical solutions must be verified to be correct before processing mission material.

- The sensitometric properties of photographic materials must be certified to be within established standards.

- A scratch test must be conducted to ensure all the rollers are operating properly and none of the guides are out of adjustment.

Once the pre-mission validation is complete, you are prepared to process the actual mission material. Before processing the film, you must attach a leader tab to the roll of film. The leading end of the film must be cut straight before splicing it to a leader tab. A piece of 7-mil Estar base film may be used as a leader tab. Processed X-ray film works well also. The leader tab should be about 12 inches long and cut to the same width as the film being processed (except when used to lead a control strip).

Mission processing includes the following procedures:

- Protect the material being processed from dirt, dust, condensation, and other solutions, such as oil and water.

- Avoid applying excessive force to the surface of the film; abnormal stress can cause pressure sensitization.

- Inspect the material being processed for physical defects before machine processing. Defects, such as tears, crimped film edges, and defective splices, can cause the film to jam in the processor.

- Ensure the film is processed in a processor that has been certified beforehand.

- Monitor the processing temperatures and the transport and replenishment rates while the film is being processed.

- Monitor the film exiting the dryer for correct dryness, possible defects, and image quality.

- Follow the instructions concerning the storage of film (before and after exposure) carefully.

## POST-MISSION IMAGE EVALUATION

After processing, the mission film is subjected to stringent post-mission evaluation for the following reasons:

- To determine whether or not the process met desired sensitometric goals and to provide feedback for process adjustment

- To reveal improper procedures or techniques and to identify defective materials

- To identify malfunctioning equipment

The post-mission evaluation should include three phases: image quality, image analysis, and laboratory evaluation.

### Image Quality

The mission film must be inspected for defects, such as fogging, streaking, pinholes, and shadows. These defects are caused by foreign matter in the camera or on the aircraft window from which the photographs were taken.

You should also look for superficial defects, such as film tears, dirt, scratches, abrasions, or foreign marks. Defects found should be described and reported as to

the actual frame position to help identify the cause, such as improper handling, processing, or other lab or maintenance procedures.

### **Image Analysis**

Image analysis consists of density measurements made with a densitometer. The properties to be evaluated should include D-min, D-max, density range, and gross fog.

### **Laboratory Evaluation**

Whenever possible, you should use samples of unexposed sensitized materials from the mission to produce sensitometric measurements and standards. This data should be used for comparison with the mission film after processing.

## **POST-MISSION MAINTENANCE EVALUATION**

Photographer's Mates working in the Aerial Processing section must be able to supply accurate maintenance feedback information to the reconnaissance system maintenance crews. Since the end results are a true measure of system performance, this feedback will do the following:

- Ensure that maintenance personnel become aware of possible system malfunctions.
- Aid in evaluating overall system performance.

The process of evaluating a photographic negative to determine system defects, as related to overall performance, is one of the most complete measures of system output. System defects noted during film evaluation should be recorded on a film maintenance feedback form and forwarded to maintenance personnel for action.

### **Frame Spacing**

On all serial-frame camera imagery and panoramic camera imagery, you should include a space between each exposed film frame. While the space may differ in width requirements, it should be present. Frame spacing defects generally indicate that a system defect exists, such as a fault in the film-advance mechanism.

### **Image Overlap**

Image overlap between successive frames provides stereo viewing capability and distortion-free imagery for a mosaic.

Instructions by the camera manufacturer contain tables with overlap specifications for serial-frame cameras and panoramic cameras. If the overlap is not met, the camera may be receiving an improper V/A (velocity/altitude aboveground level) signal from the system. In addition to improper overlap, this problem can cause blurred images.

### **Data Block**

Each frame contains a data block and other pertinent information about the mission, such as film and flight direction, frame count, and so forth. In an infrared reconnaissance set (IRRS), the data block is usually recorded along the length of film periodically. Discrepancies in the image of the data block are usually caused by a malfunction within the sensor (camera or IRRS).

### **Static**

When film loses or gains electrons (negatively charged particles), the film becomes either positively or negatively charged. This charged material seeks to return to a neutral state by transferring electrons from or to other objects. This transference can sometimes cause heat and light. When light occurs, it fogs unprocessed film emulsions and causes markings on the processed film. These markings may have a spider web or lightninglike appearance.

### **Shutter Banding**

Banding is associated with focal-plane shutters. It is caused by defective shutter operation. Banding can be identified by the presence of uneven illumination streaks across the line of flight. This defect is caused by the focal-plane shutter slit, varying in size, and an erratic shutter curtain or erratic film transport through the focal plane during the exposure cycle.

### **Camera Light Leak**

A camera light leak is often difficult to recognize. It can cause various nonimage-forming shapes and appear and disappear as the angle of light to the leak

changes. The light leak causes areas of the film to become fogged.

## **Exposure**

A negative that has detail in both the shadow and highlight areas is exposed properly. However, when evaluating the negative image, it is necessary to consider the subject matter because less exposure is required for light sandy beaches and snowcovered terrain and more exposure is required for dark terrain, such as forests and industrial sites.

When you are viewing a negative that has been exposed normally, patches of snow or light beach scenes appear overexposed. Inversely, patches of dark terrain or industrial sites appear underexposed. When the negative is completely underexposed or overexposed, the film sensitivity or filter factor (S/C) was set incorrectly or the automatic exposure control (ABC) in the camera system malfunctioned.

## **Vacuum**

The lack of adequate vacuum in a serial-frame camera permits the film to sag away from the focal plane, causing the image to be blurred. The most common indication of insufficient vacuum is crooked data blocks.

## **Miscellaneous Defects**

Reflections from the camera window of the aircraft, depending on the angle of the sun in relation to the window, can cause flare (nonimage-forming exposure) of the film.

Condensation on a camera lens can result in a halo effect surrounding film image points. This is generally caused by rapid aircraft descent immediately before a photo run.

## **AERIAL DUPLICATION**

Two methods of producing high-quality reproductions of black-and-white aerial film are in use today. One method is the specific tone reproduction method. The second method is simpler and more feasible for shipboard use, so it is discussed in more detail in this chapter. This method is called the trigradient tone reproduction method or the 1.00 print gamma method.

The following criteria is recommended as a guide to optimum photographic quality and product uniformity in producing duplicate positives or negatives from original aerial negatives. The overall objective of these recommendations is to ensure that a maximum amount of intelligence information is retained in an optimum form.

- Only the straight-line portion of the characteristic curve of the duplicating or printing material must be used. For most duplicating film, the straight line lies between densities of 0.40 to 1.80. Thus the D-min should be close to 0.40 and the D-max should be no more than 1.80 in the duplicate.

- Normally, the contrast of the duplicate is correct when the density range between the D-max and D-min falls between 0.80 and 1.20, preferably near 1.00.

The requirement for using the straight line is met when the exposure level of the printer is correct. The contrast requirement is met when the processing is correct. Specifically, the contrast of the duplicate can be increased or decreased relative to the original by increasing or decreasing gamma, respectively. To achieve these goals, you must use some form of tone control to guide the printing and processing operations. The duplication of aerial reconnaissance imagery requires that exacting standards and controls be stressed. This helps to ensure that the imagery is of the highest quality.

## **SPECIFIC TONE REPRODUCTION METHOD**

The purpose is to match the characteristic curve and the density range of the original negative to the characteristic curve of the duplicating material being used.

## **TRIGRADIENT TONE REPRODUCTION METHOD**

The trigradient tone reproduction method of duplicating is an objective method for determining printing and processing requirements. This method allows you to select one of three standardized processes. Each process produces a different contrast or gradient. The processing requirement is selected by determining whether the density range of the duplicate should be increased, maintained, or decreased. By doing so, you can alter the density range of the imagery, if necessary, in each generation. Thus the density range of the final

product conforms closely to the desired tonal values (based on a D-min of 0.40).

### **Trigradient Control Curves**

As stated previously, the trigradient tone reproduction method is based on three tone-control curves (or printer curves): high contrast, medium contrast, and low contrast.

Basically, the printer curves are produced the same way that sensi-strips are made for process monitoring. Instead of using a sensitometer to expose the film, the contact printer is used to expose the film through a step tablet. Since the amount of exposure is unknown, the horizontal axis of the curve indicates the density of the step tablet. The vertical axis represents the density produced after the duplicating film is exposed through the step tablet and processed.

Each set of printer curves consists of a family of response curves that graphically display the various tones produced in the duplicating material when it is printed under various exposure and processing conditions. Each curve is labeled with the exposure setting used on the printer to create the curve (figs. 4-30, 4-31, and 4-32). These response curves enable the density range of the imagery to be altered, so the density range of the final product conforms closely to the desired density range (1.00). The exposure of the printer is important since it determines the placement of the tonal values of the imagery being reproduced on the sensitometric response curve of the duplicating material. Ideally, all tones should fall on the straight-line portion of the response curve to ensure that the images are reproduced uniformly. The D-max of the imagery being duplicated is used to determine the required exposure since it reproduces as the D-min in the reproduction.

### **Trigradient Tone Reproduction Procedures**

The following procedures are used in the trigradient tone reproduction system:

1. Obtain the three sets of tone control curves (high, medium, and low contrasts) for the particular duplicating materials being used.

2. Determine the D-max and D-min densities on the roll of imagery to be duplicated. Remember, the D-max and D-min are the areas in which you want to retain detail, not necessarily the areas of highest and lowest density. Do not use specular highlights or

completely black areas to represent the D-max and D-min.

3. Determine the density range in the original, and determine whether the tonal range should be increased, retained, or decreased. Do this to obtain the desired density range (usually 1.0) on the duplicate.

4. Based upon results of step 3, select the set of response curves closest to the density range (high, medium, or low).

5. On the horizontal axis, locate the density of the step tablet that corresponds to the D-min density that you selected. Go up from this point until you intersect the 1.40 line and draw a tick mark.

6. On the horizontal axis, locate the density of the step tablet that corresponds to the D-max density that you selected. Go up from this point until you intersect the 0.40 line and draw a tick mark.

7. Using a straightedge, select the characteristic curve closest to your straight line. If the curves cross, choose the curve closest to your D-max because this density controls the exposure of the D-min on the duplicate.

8. Expose and process the duplicate film according to your determination in step 7.

9. Read the D-max and D-min of the duplicate film. If these values are not within established tolerances (0.05, for example), another duplicate must be made. Minor adjustments in exposure or processing may have to be made. For example, if the D-min is too high, then less exposure is required. If the D-min is within tolerance but the D-max is too low, then more development is required (to raise the contrast).

The entire tone control system is based upon data produced when the system is established. For the system to be accurate and reliable, all of the major variables must be controlled so they can be carried out on a repetitive basis.

## **CAPTIONING AERIAL PHOTOGRAPHY**

Captioning and slating hand-held aerial photography is as important as captioning and slating still and motion-picture photography that is taken on the ground. In captioning aerial photography, however, the caption information should be expanded to include the camera lens focal length, the altitude, and the direction of the aircraft from which the picture was made and the time of day the photograph was taken.

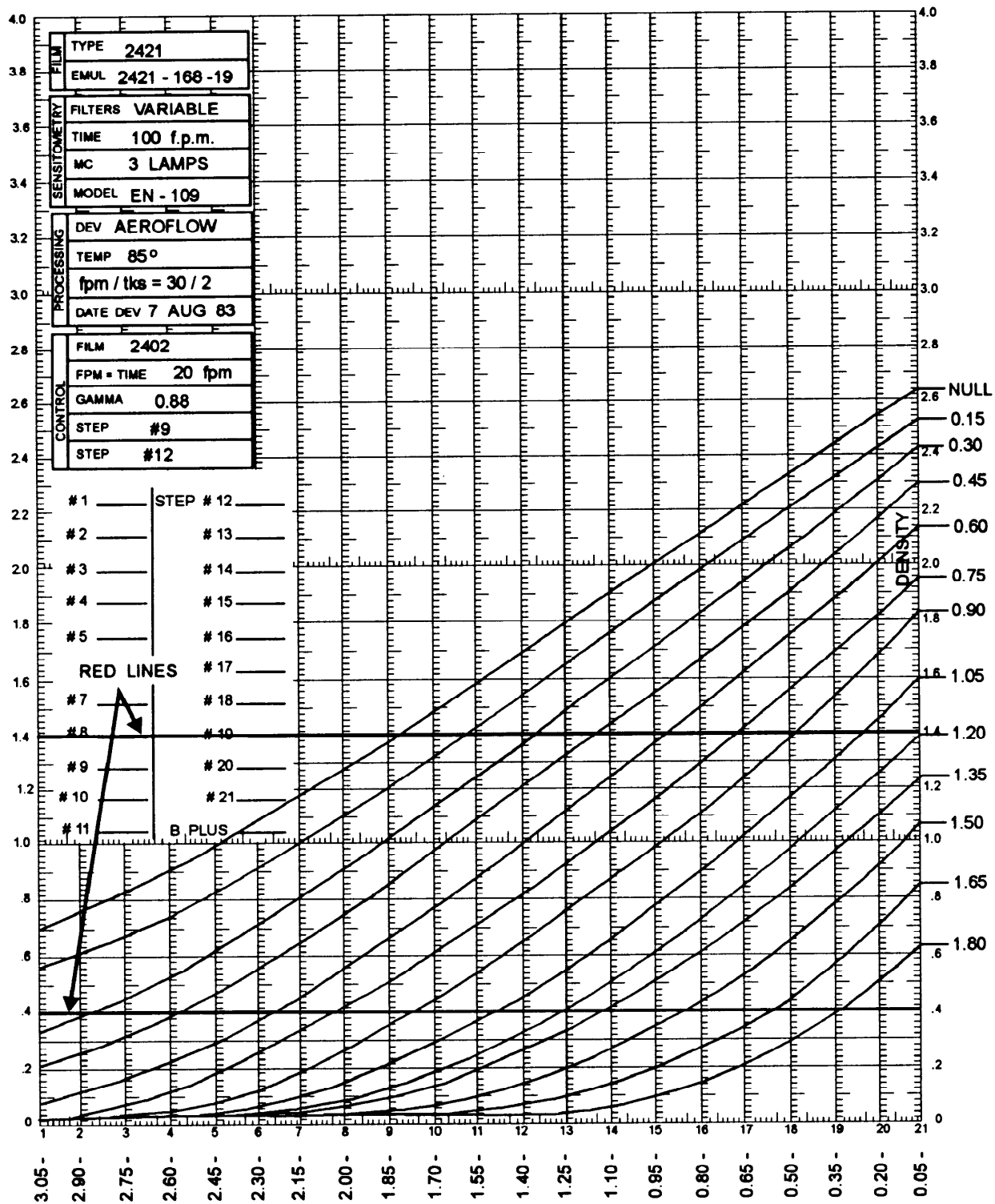

DENSITY OF ORIGINAL (CALIBRATED STEP TABLET) 46NVJ077

Figure 4-30.—Low-contrast printer curves.

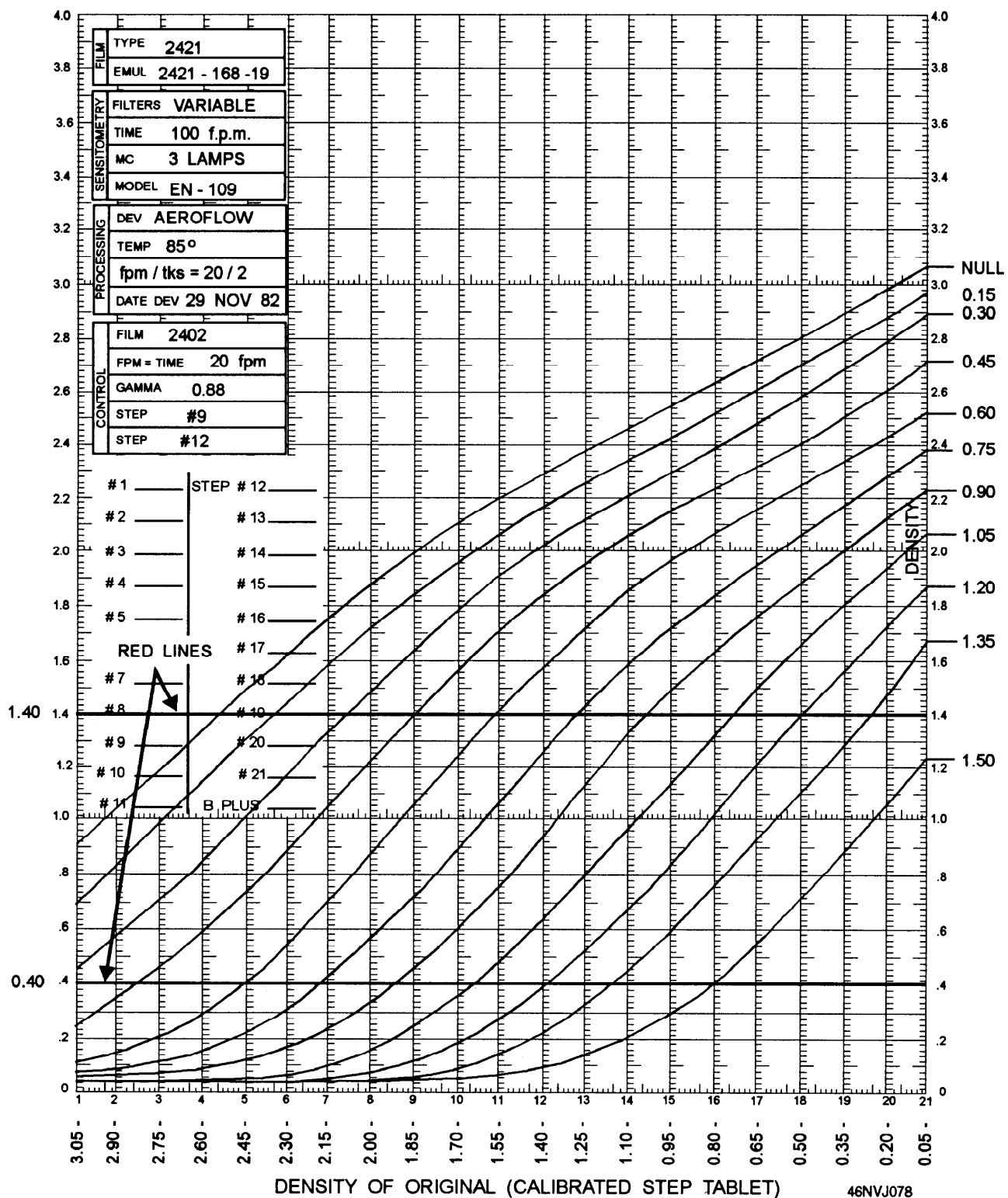

Figure 4-31.—Medium-contrast printer curves.

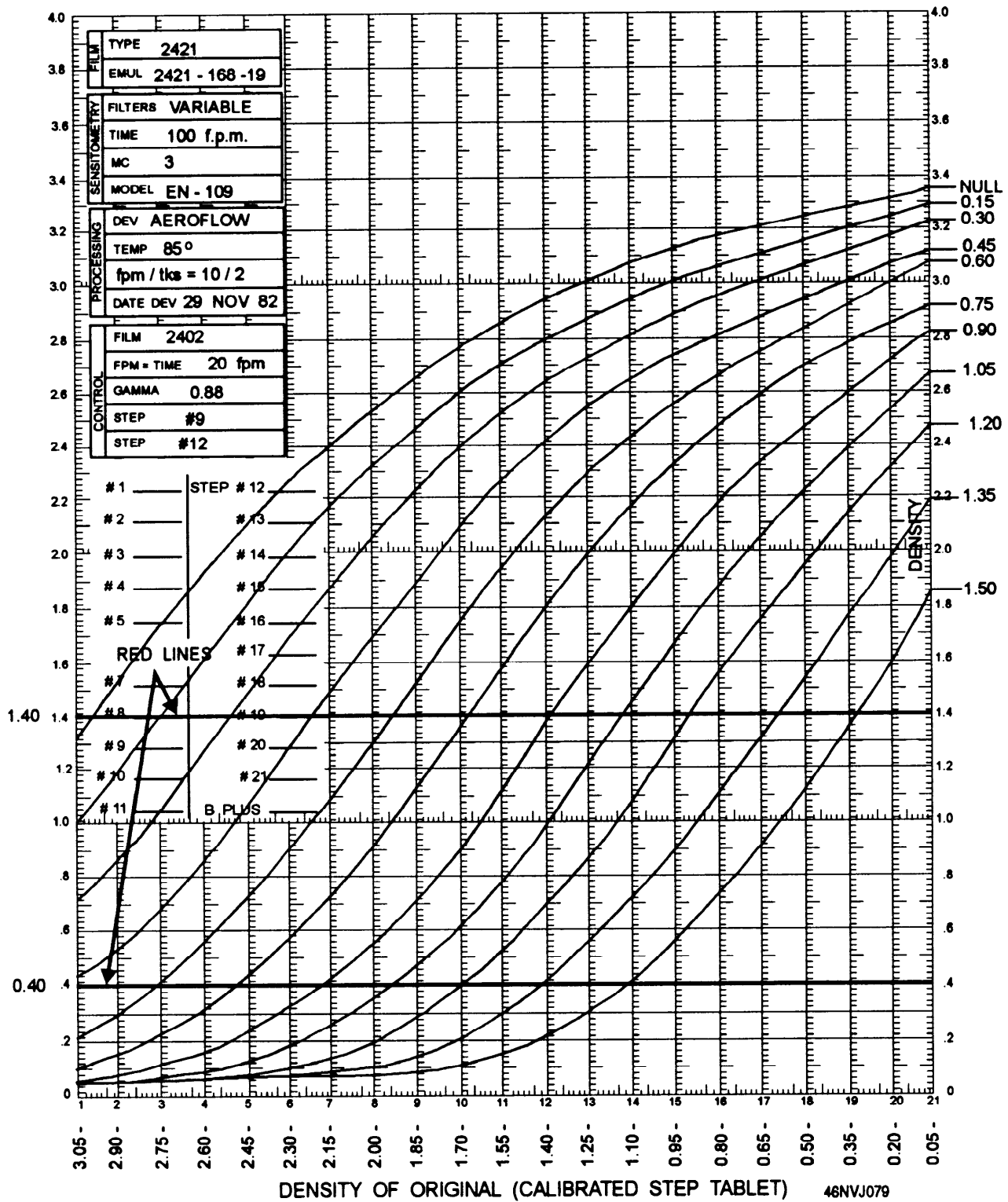

Figure 4-32.—High-contrast printer curves

Captioning for aerial intelligence photography is mandatory. It must be accomplished as outlined in the *Defense Intelligence Agency Manual*, DIAM 55-5, in

the section entitled "Aerial Photography and Airborne Electronic Sensor Imagery (Forwarding, Titling, and Plotting)."



## CHAPTER 5

# SUPPLY AND LOGISTICS

In every imaging facility, someone is in charge of ordering and maintaining supplies. Large imaging facilities have an Aviation Storekeeper (AK) assigned to manage supplies and equipment. In small imaging facilities and aboard ship, you may be assigned this responsibility as the division supply petty officer. Many Sailors are afraid of the Navy Supply System at first. This is understandable since it is such a large system. What is even more astonishing is that it is only part of an enormous supply system that includes all of the U.S. government and even provides services to Allied Military Forces in NATO. Obtaining the supplies you need from a system such as this is not easy. This chapter provides you with some information and insight into the supply system so you can approach it with confidence. As a first step, you must know the various sources from which supplies are procured.

### THE SOURCE

The Federal Government attempts to "buy American" whenever possible. The supplies you order are made under contract, purchased in wholesale lots, and are sometimes bought as individual pieces by various government agencies including the Navy. When ordering supplies, you tap into this vast reservoir of materials. The Navy Supply System draws on its own resources, the resources of other U.S. government services, or on the resources of U.S. government civilian agencies to fill your order. The supply system must catalog every item available from the government to accomplish this.

As a Photographer's Mate, you must become familiar with the Naval Supply Systems Command (NAVSUPSYSCOM). This command manages the inventories of the types of supplies you use the most. Navy inventory managers are responsible for assigned groups or categories of items of supply. Navy inventory managers include the systems commands and also project managers, bureaus, offices, and inventory control points (ICPs) under the command of NAVSUPSYSCOM. They are stocked at locations close by to ensure supplies are readily available to the fleet.

### STOCK POINTS

Stock points consist of Fleet and Industrial Supply Centers (FISCs). The mission of these activities is to furnish supply support to fleet units, shore activities, transient ships, and overseas bases. They do this by procuring, receiving, storing, issuing, and shipping or making other distribution of Navy, Defense Logistics Agency (DLA), and General Services Administration (GSA) controlled materials. The Defense Logistics Agency manages supply items used commonly by each of the military services. The following activities are stock points for the Navy Supply System:

- FISC Norfolk
- FISC Oakland
- FISC Pearl Harbor
- FISC Puget Sound
- FISC San Diego
- FISC Guam
- FISC Yokosuka
- FISC Jacksonville
- FISC Pensacola

The following scenario will provide you with some insight on methods used by inventory managers and stock points to fill a supply order (fig. 5-1):

1. USS *Chance* submits a requisition to FISC San Diego for a piece of equipment.
2. FISC San Diego receives the requisition from USS *Chance*, reviews their records, and determines that the item is not stocked at the center. FISC San Diego then refers the requisition to NAVSUPSYSCOM.
3. NAVSUPSYSCOM receives a requisition referral from FISC San Diego, reviews their master records, and determines that the equipment is stocked and available at FISC Oakland. NAVSUPSYSCOM refers the requisition to them.
4. FISC Oakland receives a requisition referral from NAVSUPSYSCOM and issues the item to USS *Chance*.

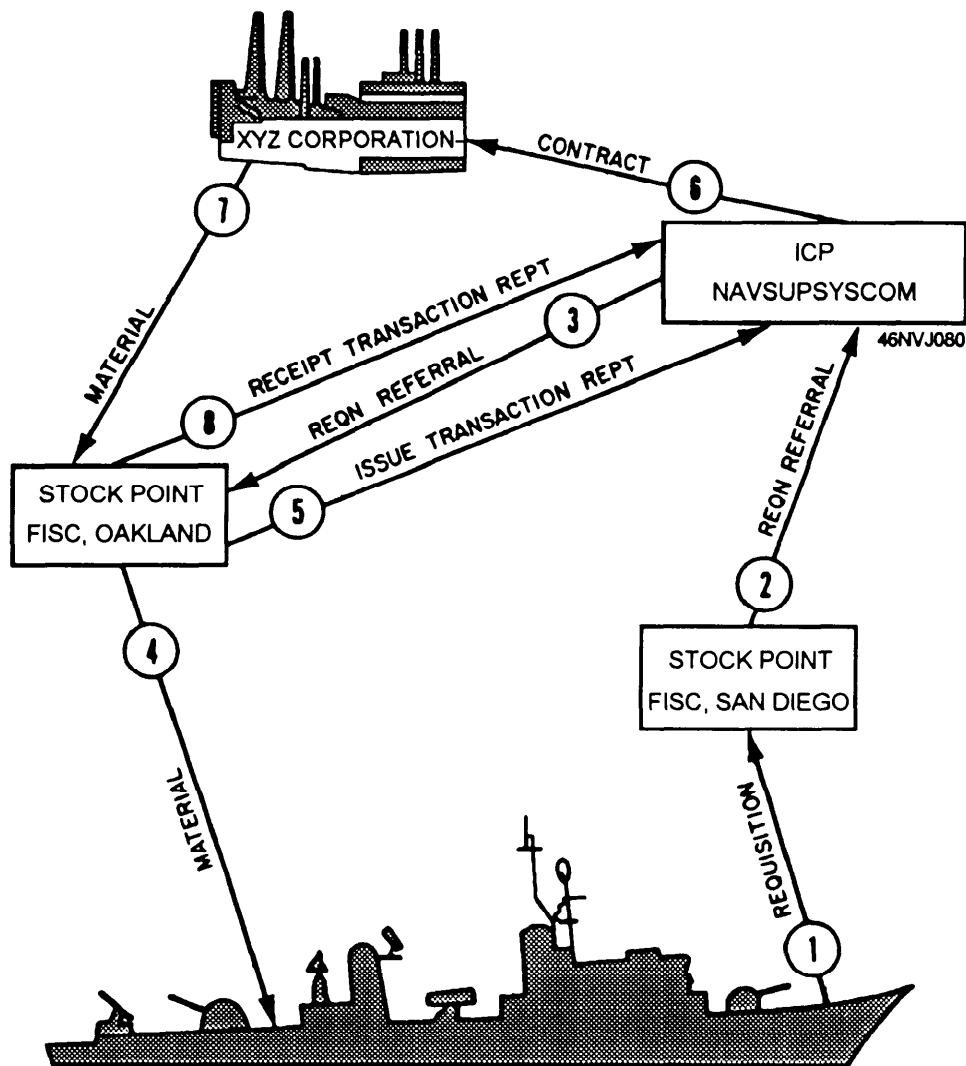

Figure 5-1.—Typical requisition request.

5. FISC Oakland makes an issue transaction report to NAVSUPSYSCOM.

6. NAVSUPSYSCOM applies the issue reports to its master record and certifies that the stock of this equipment at FISC Oakland is below the required level. NAVSUPSYSCOM then issues a contract to the XYZ Corporation to replenish FISC Oakland's stock.

7. XYZ Corporation ships the equipment to FISC Oakland.

8. FISC Oakland makes a receipt transaction report to NAVSUPSYSCOM.

### GENERAL SERVICES ADMINISTRATION

The General Services Administration (GSA), though not a part of the Department of Defense, does furnish some materials and services to the Armed

Forces. It is responsible for supporting all Federal agencies.

GSA maintains stock points at several locations throughout the country. It also has open-end contracts with major suppliers for such items as typewriters, adding machines, and calculators. A good portion of the Navy's administrative supplies and equipment is procured from this source.

The GSA makes contracts with many manufacturers to buy at an agreed upon price. Most materials used by Navy imaging facilities are on the "GSA Schedule." This means that a local store, carrying material you need, may sell it to you at the established GSA price. However, material that is stocked by the Navy must be ordered from the Navy Supply System. Prices vary between the two systems; sometimes you will pay more for goods when ordering

from Navy stock than you would pay through the GSA Schedule. The GSA "government prices" are generally 20 percent or more below the retail selling price. However, you must "buy Navy" first.

## SUPPLY CATALOGS

There are over four million types of supply items in the Department of Defense Supply System. The Navy Supply System alone stocks over one million items. So you may have access to the entire resources of the government, a common language has been developed—the Federal Catalog System.

### FEDERAL CATALOG SYSTEM

The Defense Logistics Agency (DLA) administers the Federal Catalog System that encompasses all items carried by the Department of Defense and the civil agencies of the Federal Government. Once an item is cataloged properly, this information is used for all supply functions related to the item from purchase to final disposal. When an item is placed in the Federal Catalog System, it is given a Federal Supply Classification (FSC) number.

### FEDERAL SUPPLY CLASSIFICATION SYSTEM

Each item is classified in one, and only one, four-digit FSC number. The first two digits indicate the group or major division of commodities; the last two digits are the class or subdivision of commodities within a group. Presently, the FSC has 90 groups established (some are unassigned). These stock groups cover rather broad categories of material. The second two numbers, designating the class within the group, allow more specific identification. Class numbers may identify the commodities according to their physical or performance characteristics or may be based on other items in the class that are requisitioned or issued together. Classes are used to divide types of material within a stock group and create the FSC number as follows:

6710-Cameras, Motion Picture

6720-Cameras, Still Picture

6730-Projection Equipment

Group 67  
Photographic  
Equipment

6740-Photographic Developing and  
Finishing Equipment

6750-Photographic Supplies

6760-Photographic Accessories

6770-Film, Processed

6780-Photographic Sets, Kits, and  
outfits

### NATIONAL STOCK NUMBER

As you can imagine, the FSC number is not enough to identify a specific supply item. After additional identification is added, a National Stock Number (NSN) is created. Figure 5-2 shows each element of an NSN in proper sequential order.

An NSN is made up of nine digits. This includes the National Codification Bureau (NCB) code and the National Item Identification Number (NIIN). These numbers identify supply items used by DoD. They are used to identify items independently, and most supply catalogs you use are arranged in NIIN order.

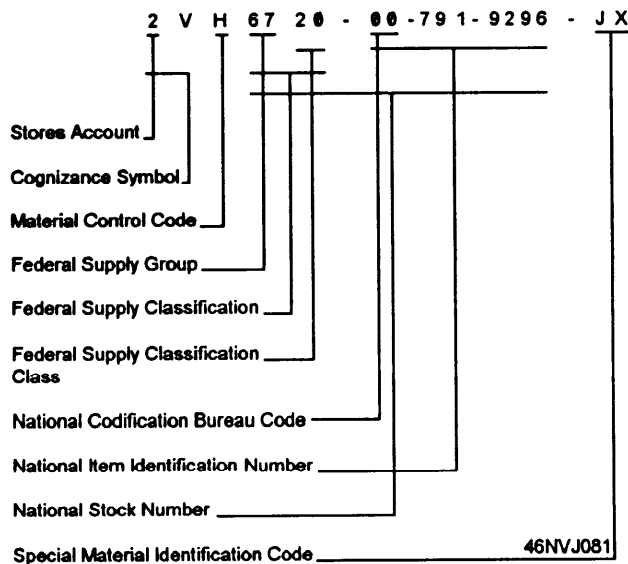

Figure 5-2.—National Stock Number.

## NAVY ITEM CONTROL NUMBERS

Items of material not included in the Federal Catalog System, but stocked or monitored in the Navy Supply System, are identified by Navy Item Control Numbers (NICNs). NICNs are 13-character item identification numbers assigned by Navy inventory managers for permanent or temporary control of selected non-NSN items.

## LOCAL ITEM CONTROL NUMBERS

Local item control numbers may be assigned to consumable items that are stocked locally, such as special developers and camera accessories, that are not otherwise identified (fig. 5-3). Local item control numbers consist of 13 characters. The first four numbers correspond to the FSC of similar NSN items; the fifth and sixth (NCB code area) are "LL" and the remaining seven are all numeric numbers.

Item control numbers assigned locally are authorized for local use only; for example, shipboard stock records, bin tags, issue documents, and so on. They are not used in requisitions because these item control numbers are meaningless to the supply source.

## IDENTIFICATION

By now, you can see that the key to getting material from "supply" is to break the code. Once you have the NSN for an item, ordering it is easy. There are a number of methods you can use to obtain the NSN of an item. One easy method is to ensure that all your supplies are identified by their numbers. You should label the bins, place identification tags on the items, and include the NSNs on your inventory list. Then, when you start to run short, you have the NSNs at hand. Most supply petty officers use this basic method to maintain careful records of their stock items. There are times when you need a new item and not a replacement. When a new

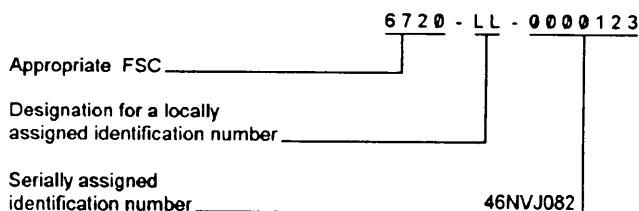

Figure 5-3.—Item control numbers assigned locally.

order is required, you must research the item to find the source.

Your local storekeepers are available to assist you. They know the system, and this can be of tremendous help to you. However, they do not know your equipment and supplies, so you will probably have to locate the specific item you want in the catalogs.

A word of warning. The supply system is highly automated. Most foul-ups occur because the requisition is not completed properly. If you were off one digit in the stock number or use the wrong NSN, you may receive an aircraft engine instead of a typewriter.

In this case, your unit has spent its money wastefully, and a stock item is withdrawn from the supply system that may be needed by another ship or station. You also experience an unnecessary delay because the material must be reordered.

Even when replenishing supplies, you should check the current stock numbers. Normally, when a supply item becomes obsolete, the supply system automatically tills your order with the current item that replaced it. However, there are occasions when the current item is different from the original or uncertainty exists as to what you really want. Then your requisition is returned, and you have wasted time.

A number of catalogs and lists are available for you to use. When ordering replacement supplies or equipping an activity, you should use one or more of the following catalogs: the *Management List-Navy*, the *Afloat Shopping Guide*, the allowance list of your activity, the *DoD Consolidated Federal Supply Catalog*, the *Photographic Equipment List*, the *Navy Stock List*, and the *GSA Catalog*.

When you are ordering repair parts, the *Manufacturers' Manuals*, the *Illustrated Parts Breakdown*, and the *Consolidated Master Cross-Reference List (C-MCRL)*, or (CRL), permit you to trace the part number provided by the manufacturer and locate the corresponding NSN.

For ordering publications and keeping the technical and administrative library up to date, you should use the *Navy Stock List of Publications and Forms*. The information that follows describes the content of the various publications and how they can be of use to you.

## MANAGEMENT LIST-NAVY

The *Management List-Navy (ML-N)* is helpful when you are preparing requisitions. It lists stock items



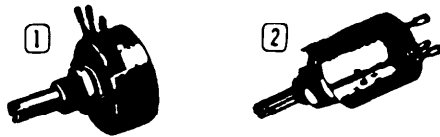

Specification Data—MIL-R-94

TYPE	TAPER	WATT'S	BUSHING SIZE	SHAFT DIA.	BODY DIM.	FIG
RV2	A	1	3/8-32	1/4	.64 x .42	1
RV2	C	1/2	3/8-32	1/4	.64 x .42	1
RV4	A	2	3/8-32	1/4	.90 x .45	1
RV4	C, F	1	3/8-32	1/4	.90 x .45	1
RV5	A	1/2	1/4-32	1/8	.75 x .37	1
RV6	A	1/2	1/4-32	1/8	.50 x .37	2
RV6	C, F	1/4	1/4-32	1/8	.50 x .37	2

1 WATT

Locking bushing, 5/8 in. lg shaft.

	Ohms	Mil Type
00-815-5498	10K	RV2LAYSA 103A

Standard bushing, 7/8 in. lg shaft.

	Ohms	Mil Type
00-835-8870	1.5K	RV2N AYSD152A
00-577-6803	10K	AYSD103A
00-964-6059*	10K	BYSD103A
00-853-0798	100K	AYSD104A

\*With SPST switch.

2 WATT

Locking bushing, 5/8 in. lg shaft.

	Ohms	Mil Type
00-681-8688	50	RV4LAYSA 500A
00-503-5984	100	101A
00-503-6218	250	251A
00-539-4897	500	501A
00-646-5958	1K	102A
00-539-2567	2.5K	252A
00-539-2479	5K	502A
00-518-5595	10K	103A
00-501-7314	25K	253A
00-501-5184	50K	503A
00-665-4992	100K	104A
00-552-2093	250K	254A
00-518-5593	500K	504A
00-518-5609	1MEG	105A
00-552-5487	5MEG	505A

Locking bushing, 7/8 in. lg shaft.

	Ohms	Mil Type
00-577-3717	2.5K	RV4LAYSD 252A
00-577-3645	25K	253A
00-556-3042	100K	104A
00-023-7931	1MEG	105A

Standard bushing, 1/2 in. lg shaft.

	Ohms	Mil Type
00-542-8046	1K	RV4NAYSB 102A
00-646-5957	10K	103A
00-646-5981	25K	253A
00-643-6284	50K	503A
00-542-8048	100K	104A
00-542-8051	1MEG	105A

Standard bushing, 7/8 in. lg shaft.

	Ohms	Mil Type
00-556-3041	100	RV4NAYSD 101A
00-552-2859	500	501A
00-552-5478	1K	102A
00-577-9976*	1K	
00-539-5013	2.5K	252A
00-643-5626	5K	502A
00-578-4471	7.5K	752A
00-556-3350	10K	103A
00-552-5479	15K	153A
00-539-1559	25K	253A
00-539-4900	50K	503A
00-644-6693	100K	104A
00-552-5476	250K	254A
00-893-9499	500K	504A
00-501-7307	1.5MEG	155A
00-655-3312	2MEG	205A

\*With SPST switch, MIL Spec type RV4NBYS102A.

Standard bushing, 1-1/4 in. lg shaft.

	Ohms	Mil Type
00-811-1750	2.5K	RV4NAYSG 252A

Standard bushing, 2-1/2 in. lg shaft.

	Ohms	Mil Type
00-539-4999	100	RV4NAYSK 101A
00-539-2568	250	251A
00-557-4637	500	501A
00-500-7588	1K	102A
00-542-8724	2.5K	252A
00-666-1036	5K	502A
00-665-5095	10K	103A
00-581-2846*	10K	
00-500-7879	25K	253A
00-542-8744	50K	503A
00-339-4576	100K	104A
00-539-4578	250K	254A
00-539-4998	500K	504A
00-552-2254	1MEG	105A

\*With SPST switch, MIL Spec type RV4NBYSK103A

C TAPER

1/4 WATT

Standard bushing, 7/8 in. lg shaft.

	Ohms	Mil Type
00-802-7951	5K	RV5NAYSD 502C

	Ohms	Mil Type
00-851-5648	5K	RV6NAYSD 502C
00-954-4038	10K	103C

1 WATT

Locking bushing, 7/8 in. lg shaft.

	Ohms	Mil Type
00-578-9051	1MEG	RV4LAYSA 105C

Standard bushing, 7/8 in. lg shaft.

	Ohms	Mil Type
00-681-6172	500	RV4NAYSD 501C
00-552-3480	10K	103C

Standard bushing, 7/8 in. lg. (Shaft and panel sealed.)

	Ohms	Mil Type
00-542-9406	500	RV4SAYSD 501C

Standard bushing, 2-1/2 in. lg shaft.

	Ohms	Mil Type
00-553-9970	2.5K	RV4NAYSK 252C
00-578-4134	50K	503C

F TAPER

1/4 WATT

Locking bushing, 5/8 in. lg shaft.

	Ohms	Mil Type
00-752-3377	50K	RV6LAYSA 503E

1 WATT

Locking bushing, 5/8 in. lg shaft.

	Ohms	Mil Type
00-683-5996	10K	RV4LAYSA 103E

INDUSTRIAL TYPE. A taper. Fully inclosed body with 1/4 in. diameter slotted shaft and mounted by a 3/8 - 32 thread bushing.

Single section

2-1/4 Watt at 70 deg C, body dimension. 11/16 in. lg x 1-5/32 in. diameter, 1-7/16 in. lg shaft, panel sealed bushing, 3 solder lug terminals.

00-482-4992	350 OHMS	10% tol
-------------	----------	---------

3 Sections

2 Watt at 70 deg C, body dimension. 1-29/32 in. lg x 1-5/32 in. diameter, 5/8 in. lg shaft, 9 solder lug terminals.

00-264-7818	2.5 meg, 2.5 meg, 20%, 25K, 10%
-------------	---------------------------------

46NVJ084

Figure 5-5.—Sample page from the *Afloat Shopping Guide*.

name. The primary equipment is followed first by its components, and second, when applicable, by related equipment and components. The name of the equipment is alphabetically arranged, and each type of specific equipment is alphanumeric by type of designation under the equipment listing or by physical characteristics when no type of designation exists.

## **GSA CATALOG**

The General Services Administration (GSA) has inventory control over and is responsible for cataloging non-military items that are used by both military and civil agencies of the United States government. The *GSA Supply Catalog* is a handy reference for identifying consumable types of material.

The *GSA Supply Catalog* is published in four volumes. Volume 1 contains an alphabetical index. Volume 2 contains an NSN index with current prices and other ordering information and changes to volume 1. Volume 3 contains descriptions of material in a format similar to the ASG. Volume 4 is a price list for volume 3.

## **KODAK PUBLICATIONS**

There are a number of catalogs published by the Eastman Kodak Company that lists the NSNs of imaging equipment and materials that are on the GSA schedule. One publication that may be useful to you, as a supply petty officer, is the *Commodity Oriented Procurement System (Electronic Data Interchange)*. This publication is commonly referred to as COPS or EDI.

COPS is a catalog for Kodak photographic products and other items that are available through DGSC, Richmond, Virginia. COPS/EDI is a computer-to-computer system. To use the system, you must first fill out a requisition. The requisition must then be sent to base supply or your supply department. The order must then be transmitted to DGSC. DGSC transmits your order by computer to computers at various Kodak Regional Distribution Centers. The order is sent directly to your activity in 5 days for factory-stocked items and 30-45 days for special orders.

## **NAVY STOCK LIST OF PUBLICATIONS AND FORMS**

The *Navy Stock List of Publications and Forms*, NAVSUP P-2002, commonly referred to as the "I Cog Catalog," consists of three sections as follows:

Section I-Alphabetic/Numeric Listing of Form Numbers, Publications, Hull Numbers, Electronic Model Numbers, and Standard Subject Identification Codes for Cog II Forms.

Section II-Alphabetic Listing of Publications and Forms by Title/Nomenclature.

Section III-Numeric Listing of Publications and Form Stock Numbers followed by technical directives (by type and directive number).

Publications and Forms are sequenced together. Microfiche editions of NAVSUP P-2002 are issued quarterly; each edition reflects all current Cog 0I and II Publications and Forms. Section I and section III reflect information, such as "Canceled," "No Superseding Item," "Superseded By," and "Replaced By."

The Introduction to *Navy Stock List of Publications and Form* provides detailed information about the columnar arrangement of the stock list. Additionally, it provides the instructions for requisitioning publications and forms.

## **MANUFACTURERS' PART NUMBERS**

When replacement parts are needed, either to repair equipment or for ready spares, you usually must know the part number assigned by the manufacturer.

Normally, the manufacturer affixes a part number on each item manufactured. This part number, coupled with knowledge of application and usage, leads to the nomenclature and National Stock Number (NSN) of the part. The part number can be verified by referencing it to the appropriate Illustrated Parts Breakdown (IPB). The NSN may be obtained by referencing a part number to the appropriate *Consolidated Master Cross-Reference List (C-MCRL)*. You should remember that part numbers may be duplicated by various manufacturers; therefore, the Federal Supply Code (FSC) for manufacturers must be considered when cross-referencing a part number to an NSN.

## **Drawing Number**

A drawing number consists of letters or numbers, or a combination of letters and numbers, that are assigned to a particular drawing for identification purposes. The activity controlling the drawing (normally the manufacturer) assigns the number conforming to their drawing numbering system. One drawing may apply to several items; thus other distinguishing information is required to identify the item on the drawing.

Drawing numbers may be used to identify microfilm that may be available on the equipment or assembly. Some large assemblies are illustrated in IPBs but are not broken down sufficiently to show identifying data for their component parts. By obtaining the drawing number of the larger item and cross-referencing it to the applicable microfilm, you can obtain sufficient identifying information for the component part.

## **Specification Number**

A specification number is assigned to documents describing the characteristics and properties of material purchased by the Federal Government. These specifications are used by purchasing officers to ensure that all of the requirements for the material are met. Specification numbers on some support equipment are particularly useful when you are trying to procure component parts.

## **Nameplate**

Some equipment has a nameplate attached that provides such information as the manufacturer's name or code, make or model number, serial number, size, voltage, phase, NSN, and so on. This information is particularly helpful when you are requesting material that is not subject to the Federal Catalog System.

## **MANUFACTURERS' INSTRUCTION BOOKS**

Most equipment purchased for Navy imaging has with it an instruction book or a technical manual that is published by the manufacturer. You can often use it to help you identify specific parts, since this technical manual often includes parts lists, detailed drawings, and specifications.

## **ILLUSTRATED PARTS BREAKDOWN**

Illustrated Parts Breakdown (IPB) publications are an important source of information, particularly for ordering specific support-equipment parts. Used properly, they provide the information necessary to identify a part number. In some cases, IPBs provide

cross-reference data that can be used when the prime item requested is not in stock.

An IPB is prepared by the manufacturer for most major items of imaging equipment and accessories. The IPB is designed to enable supply and maintenance personnel to identify and order replacement parts for equipment. Procurable assemblies and detail parts are illustrated and listed for quick identification of assemblies and their component parts. The items are arranged continuously in assembly breakdown order. The illustrations are placed as near as possible to their appropriate listing (fig. 5-6).

Although slight variations in format exist among the various IPBs, each one includes the following major sections:

The INTRODUCTION includes general information about the equipment, contents of the publication, and instructions for use. You should refer to the introduction before attempting to use an unfamiliar IPB.

The GROUP ASSEMBLY PARTS LIST consists of a breakdown of the complete unit into major components, systems, installations, assemblies, and detail parts. Generally, parts are indexed in disassembly order. In some instances, assemblies or installations are shown in assembled form in one figure and the detail parts are illustrated in another figure.

The NUMERICAL INDEX lists part numbers in alphanumeric order, and each part number is cross-referenced to the figure and index number where it is shown. This section also shows the total quantity of each part used in the equipment, material source code, and NSN, when applicable.

The REFERENCE DESIGNATION INDEX lists, in alphanumeric order, reference designators (example: B1, J1, K7, and so on) on schematic and wiring diagrams. The index also lists part numbers and index numbers to indicate where the parts are located in the IPB.

## **CONSOLIDATED MASTER CROSS-REFERENCE LIST**

The *Consolidated Master Cross-Reference List* (C-MCRL) is designed to provide a cross-reference from a reference number, such as a manufacturer's part number, a drawing number, a design control number, and so on, to an assigned NSN. Part I of the C-MCRL is designed to assist you in identifying items in the



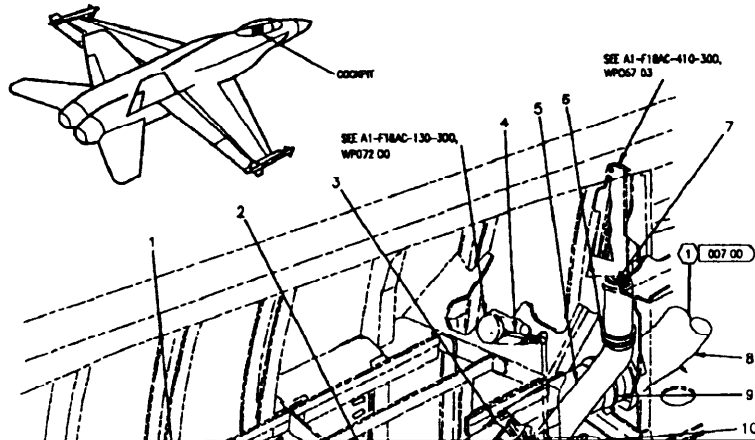

INDEX NO.	PART NUMBER	DESCRIPTION							UNITS PER ASSY	USE ON CODE	SM&R CODE
		1	2	3	4	5	6	7			
		COCKPIT, LEFT CENTER									
1	NAS673V2								1		PAOZZ
	AN960JD10L								1		PAOZZ
2	74AB30723-1013								1	A	IXOZZ
	74AB30723-1017								1	B	XBOZZ
	74AB30723-1011								1	C	XBOZZ
	74AB30723-1018								1	D	XBOZZ
3	JMA48C13040BR								1	*	PAOZZ
	TA12C53D40HR								1	*	PAOZZ
	751-40-BHT								1	*	PAOZZ
	751AA6-BHT								1	*	PAOZZ
	NAS673V2								1	*	PAOZZ
	NAS673V6								2	E	PAOZZ
	AN960JD10LL								2	H	PAOZZ
	74A314203-2007								1	H	PAOZZ
4	74AB00778-1005								1		WGOZZ
	74AB30724-1007								1		PBOZZ
	74AB30724-1005								1	*	PBOZZ
	NAS673V2								2		PAOZZ
	AN960JD10L								2		PAOZZ
6	NS21939ACB24								1		PAOZZ
	NAS673V6								1		PAOZZ
	AN960JD10LL								1		PAOZZ
	NAS42DD6-14								1		PAOZZ
7	NAS1922-0150-3								2		PAOZZ
8	74AB30717-1003								1		IXOZZ
	74AB30717-1001								1	*	XBOZZ
	NAS673V3								2		PAOZZ
	AN960JD10LL								2		PAOZZ
9	NAS1922-0225-3								1	*	PAOZZ
10	AE16340-4								1	*	PAOZZ
	B44360T-04								1	*	PAOZZ
	AF541704								1	*	PAOZZ
	TF341704								1	*	PAOZZ
	ST7H223T4								1		PAOZZ
	NAS1252-716L								1		PAOZZ
11	M25984/1-250								1		PAOZZ
12	W901K400E								1	*	PAOZZ
	14J12-40A								1	*	PAOZZ
13	M25984/1-145								1	E	PAOZZ
	M25984/1-250								1	F	PAOZZ

\* ALTERNATE OR EQUIVALENT PARTS.  
(WPO02 00)

Figure 1. Cockpit, Left Center (Sheet 2)

46NVJ085

Figure 5-6.—Illustrated Parts Breakdown.

MCRL PART I			
REF. NO.	FSCM	RNVC	NSN
55599	62983	2	4320-00-057-0782
556	24161	2	3030-00-269-9669
556-012-001	16665	2	5950-00-237-7237
556-1137	46859	2	5841-00-323-0747
556-1182	46859	2	5365-00-323-0749
556-2332	46859	2	5305-00-433-9273
556-35-1246FW160P			
2	01351	2	3020-00-967-4607
556-3541	46859	2	5365-00-514-0363
556-3541-1	46859	2	5365-00-200-5226

MCRL PART II			
NSN	REF. NO.	FSCM	RNVC
4320-00-057-0782	55599	62983	2
5365-00-200-5226	556-3541-1	46859	2
5950-00-237-7237	556-012-001	16665	2
3030-00-269-9669	556	24161	2
5841-00-323-0747	556-1137	46859	2
5841-00-323-0749	556-1182	46859	2
5305-00-433-9273	556-2332	46859	2
5365-00-514-0363	556-3541	46859	2
3020-00-967-4607	556-35-1246FW160P		
	2	01351	2

46NVJ086

Figure 5-7.—Columns of the Consolidated Master Cross-Reference List, part I and part II.

supply system. Part II includes supply items that are used by all military services; therefore, many NSNs will be identified in the C-MCRL that are not listed in the *Management List-Navy* (fig. 5-7).

The information obtained in part I of the C-MCRL is shown in table 5-1.

The Reference Number Variation Code (RNVC) row indicates (by use of the numbers 1,2,3, and 9) those items that require supplementary data to identify them fully. These codes are as follows:

Code 1 —Nonidentifying—The reference number does not completely identify the item. When the reference number is cited, it must be accompanied by

additional descriptive data, such as color, length, and rating.

Code 2—Identifying—The reference number in company with the Federal Supply Code for Manufacturers (FSCM) completely and uniquely identifies the item of supply. Code 2 items may also have nonidentifying reference numbers.

Code 3—The reference number is a vendor's number or a Source Control Item.

Code 9—This code is used to indicate (1) the reference number is for information only and (2) the reference number or specification is obsolete or superseded.

Table 5-1.-Part I of the Consolidated Master Cross-Reference List

<u>COLUMN TITLE</u>	<u>DATA PRINTED</u>
Reference No.	A number, other than an activity stock number, used to identify an item of production.
Mfr. Code	The applicable manufacturer's assigned five-digit code, as listed in the <i>Cataloging Handbook</i> , H4-2.
RNVC (Reference Number Variation Code)	A code indicating whether the reference number is item-identifying or requires additional data to identify the item of supply.
National Stock No.	The NSN assigned to the reference number.

Part II of the C-MCRL presents the same data in National Item Identification Number (NIIN) sequence.

### OBTAINING MATERIAL

Once you have found the stock number, you are read to requisition supplies. Most material is obtained by requisition, but purchase is used to procure non-standard material or to meet emergency requirements. The simplest form of a requisition is merely a request for material made out on the appropriate Navy form and drawn at a naval supply activity. If material must be obtained by open purchase to fill specialized needs, this also is usually handled by the local supply department or activity.

### COMPUTERIZED SYSTEMS

There are different computerized systems being used at sea and on shore-based activities. The *Shipboard Uniform Automated Data Processing System*, known commonly as SUADPS, is the supply-computerized system that is used at sea. SUADPS is broken down into two subsystems: the *Shipboard Nontactical Automated Data Processing Program I*, or SNAP I, which is used on aircraft carriers, and the *Shipboard Nontactical Automated Data Processing Program II*, or SNAP II, which is used on smaller ships. The *Uniform Automated Processing System*, or UADPS, is the computerized-supply system being used on shore-based activities.

### REQUISITION FORMS

There are a number of requisition forms for ordering supplies and services. The form that you should use to requisition materials depends on the

supply source, and it also depends on whether your local supply system is manual or automated.

For your requisition to be processed, it must be submitted on the correct form. The following requisition forms are the ones used most in the supply system:

1. DoD Single-Line Item Requisition System Document (*Manual*), DD Form 1348 (6-PT). This form is used in manual supply systems for purchasing standard-stock items (fig. 5-8).

2. Single-Line Item Consumption/Requisition Document (*Manual*), DD Form 1250-1 (7-PT). This form is used in manual supply systems for purchasing standard-stock items (fig. 5-9).

3. NON-USN Requisition (4491), DD Form 1250-2 (7-PT). This form is used in computerized-supply systems for purchasing open-purchase items (fig. 5-10).

4. Requisition and Invoice/Shipping Document, DD Form 1149 (Multiple Requests). This form is used as a shipping and invoice document and is included with the material being shipped. After the material is received, the original copy must be signed and returned to the sender (fig. 5-11).

When filling out the mechanical forms, use a typewriter or ball-point pen. Do not use a pencil because pencil marks smudge and cause errors during the requisition processing. When you are preparing requisitions, it is not necessary to space the entries within the "tic" marks printed on the forms, but you must get each entry inside the proper data blocks. The communication zero (Ø) is used on MILSTRIP requisitions to eliminate confusion between the numeric zero and an alphabetic "O".

DOC IDENT	ROUT IDENT	FISC	MIN	ADD	QUANTITY	DOCUMENT NUMBER	REQUISITION IS FROM	STOCK NUMBER	V17700 USS UNDERWAY CVN 82
SEND TO: FISC NORFOLK SERVMART									
DOC IDENT	ROUT IDENT	FISC	MIN	ADD	QUANTITY	DOCUMENT NUMBER	REMARKS	TOTAL COST LIMITATION 250.00	JANE B. DOE LT SC USN
DOC IDENT	ROUT IDENT	FISC	MIN	ADD	QUANTITY	DOCUMENT NUMBER	REMARKS	TOTAL COST LIMITATION 250.00	JANE B. DOE LT SC USN

Figure 5-8.—DD Form 1348 (6-PT).

1. REG. DATE	2. DEPT. NO.	3. URGT	4. RDD	5. LOCATION	6. SIM	7. ISSUE DATE	A. REGN QTY	B. REGN. NO.		
3200										
8. NOUN NAME OR REF SYM.	9. FPR	10. APL/AEL/ACID	11. INV QTY	12. NIS	13. N/C	14. C. OBL AMT	15. D. POSTED	16. S/R (REGN O / R)		
R 54054	EM01									
17. EQUP COSAL SUPPTD	18. YES	19. NO	20. URG	21. MART	22. S/R (ISSUE)					
YES										
18. SC	19. COG	20. MCC	21. FT	22. FISC	23. DE	24. MIN	25. QUANTITY	26. UNIT PRICE	27. EXTENDED PRICE	28. FUND
G	SERVMART	LT	1	350	00	MVO	NC			
29. REMARKS	TOTAL COST LIMITATION 350.00	J.D. DOE LT SC USN	30. APPROVED BY:	31. RECEIVED BY:						
11. 213	12. 41816	13. 7	14. 30	15. 31132133134135	16. 36137138139	17. 4014142143	18. 44	19. 45	20. 4614748149150	21. 51
AOA	NNZ	R	54054	3301	0426	A	NC			
DOC IDENT	RTG IDENT	M S S	SVC	VIC	JUL DATE	SERIAL	D E M	S V C	SUPPL ADDRESS	S I G

Figure 5-9.—DD Form 1250-1 (7-PT).

Under certain circumstances, requisitions may be submitted by message or letter. Normally, requisitions are submitted on one of the forms listed previously.

To prepare and use requisition forms, you must become familiar with certain terms. You must also become familiar with the use of the forms in the *Military Standard Requisitioning and Issue Procedures (MILSTRIP)* and the *Uniform Material Movement and Issue Priority System (UMMIPS)*.

**MILSTRIP**

The MILSTRIP system provides a "common language" for requesting and supplying material within

and among the Army, Navy, Air Force, Marine Corps, and the General Services Administration (GSA). It also explains the requisition documents that can be processed by electronic-processing equipment and contains all the information necessary to issue, ship, and account for the material requested.

Some of the terms in the "common language" of MILSTRIP are as follows:

**BACK ORDER.** A requisition that cannot be filled by the supply activity from current stock and is being held until additional stock is received. When the stock is received, the issue will be made.

NON-NSN REQUISITION (4491)																																																																																																																																																																																																																																																																																																																																																																																																																																																																																																																																																																																																																																																																																																																																																																																																																																																																																																																																																																																																																																																																																																																																																																																																																																																																																																																																																																																																																																																																			
A. REQ. DATE 9292						B. DEPT. NO EB01						C. URGY B						D. RDO						E. LOCATION						F. <input type="checkbox"/> SM <input checked="" type="checkbox"/> NON-SM						G. ISSUE DATE						H. REQN. QTY 1						L. REQN. NO. V17700 9294-0731																																																																																																																																																																																																																																																																																																																																																																																																																																																																																																																																																																																																																																																																																																																																																																																																																																																																																																																																																																																																																																																																																																																																																																																																																																																																																																																																																																																																																			
J. NOUN NAME OR REF SYM VALVE												K. FPR						L. APL/AEL/ACID 883674582												M. INV QTY						N. <input type="checkbox"/> NS <input checked="" type="checkbox"/> NC						O. OBL. AMT. 235.00						P. POSTED S/R (REGN O/S) X																																																																																																																																																																																																																																																																																																																																																																																																																																																																																																																																																																																																																																																																																																																																																																																																																																																																																																																																																																																																																																																																																																																																																																																																																																																																																																																																																																																																																			
JOB CONTROL NUMBER												R. WC						S. JSM						T. EIC						U. EQUIP COSAL SUPPTD <input checked="" type="checkbox"/> YES <input type="checkbox"/> NO						V. <input type="checkbox"/> URG <input type="checkbox"/> MART						OPTAR LOG X																																																																																																																																																																																																																																																																																																																																																																																																																																																																																																																																																																																																																																																																																																																																																																																																																																																																																																																																																																																																																																																																																																																																																																																																																																																																																																																																																																																																																									
G. UIC						V. 17700						R. EB01						S. 0921						T. IC01						DOCUMENT NUMBER						S. R (ISSUE)																																																																																																																																																																																																																																																																																																																																																																																																																																																																																																																																																																																																																																																																																																																																																																																																																																																																																																																																																																																																																																																																																																																																																																																																																																																																																																																																																																																																																															
DOCUMENT IDENTIFIER						ROUTING IDENTIFIER						NAVY ITEM CONTROL NUMBER (NICN) OR P-NICN												UNIT OF ISSUE						QUANTITY						REQUISITIONER						DATE						SERIAL						SC																																																																																																																																																																																																																																																																																																																																																																																																																																																																																																																																																																																																																																																																																																																																																																																																																																																																																																																																																																																																																																																																																																																																																																																																																																																																																																																																																																																																													
1	2	3	4	5	6	7	8	9	10	11	12	13	14	15	16	17	18	19	20	21	22	23	24	25	26	27	28	29	30	31	32	33	34	35	36	37	38	39	40	41	42	43	44	45	46	47	48	49	50	51	52	53	54	55	56	57	58	59	60	61	62	63	64	65	66	67	68	69	70	71	72	73	74	75	76	77	78	79	80	81	82	83	84	85	86	87	88	89	90	91	92	93	94	95	96	97	98	99	100	101	102	103	104	105	106	107	108	109	110	111	112	113	114	115	116	117	118	119	120	121	122	123	124	125	126	127	128	129	130	131	132	133	134	135	136	137	138	139	140	141	142	143	144	145	146	147	148	149	150	151	152	153	154	155	156	157	158	159	160	161	162	163	164	165	166	167	168	169	170	171	172	173	174	175	176	177	178	179	180	181	182	183	184	185	186	187	188	189	190	191	192	193	194	195	196	197	198	199	200	201	202	203	204	205	206	207	208	209	210	211	212	213	214	215	216	217	218	219	220	221	222	223	224	225	226	227	228	229	230	231	232	233	234	235	236	237	238	239	240	241	242	243	244	245	246	247	248	249	250	251	252	253	254	255	256	257	258	259	260	261	262	263	264	265	266	267	268	269	270	271	272	273	274	275	276	277	278	279	280	281	282	283	284	285	286	287	288	289	290	291	292	293	294	295	296	297	298	299	300	301	302	303	304	305	306	307	308	309	310	311	312	313	314	315	316	317	318	319	320	321	322	323	324	325	326	327	328	329	330	331	332	333	334	335	336	337	338	339	340	341	342	343	344	345	346	347	348	349	350	351	352	353	354	355	356	357	358	359	360	361	362	363	364	365	366	367	368	369	370	371	372	373	374	375	376	377	378	379	380	381	382	383	384	385	386	387	388	389	390	391	392	393	394	395	396	397	398	399	400	401	402	403	404	405	406	407	408	409	410	411	412	413	414	415	416	417	418	419	420	421	422	423	424	425	426	427	428	429	430	431	432	433	434	435	436	437	438	439	440	441	442	443	444	445	446	447	448	449	450	451	452	453	454	455	456	457	458	459	460	461	462	463	464	465	466	467	468	469	470	471	472	473	474	475	476	477	478	479	480	481	482	483	484	485	486	487	488	489	490	491	492	493	494	495	496	497	498	499	500	501	502	503	504	505	506	507	508	509	510	511	512	513	514	515	516	517	518	519	520	521	522	523	524	525	526	527	528	529	530	531	532	533	534	535	536	537	538	539	540	541	542	543	544	545	546	547	548	549	550	551	552	553	554	555	556	557	558	559	560	561	562	563	564	565	566	567	568	569	570	571	572	573	574	575	576	577	578	579	580	581	582	583	584	585	586	587	588	589	590	591	592	593	594	595	596	597	598	599	600	601	602	603	604	605	606	607	608	609	610	611	612	613	614	615	616	617	618	619	620	621	622	623	624	625	626	627	628	629	630	631	632	633	634	635	636	637	638	639	640	641	642	643	644	645	646	647	648	649	650	651	652	653	654	655	656	657	658	659	660	661	662	663	664	665	666	667	668	669	670	671	672	673	674	675	676	677	678	679	680	681	682	683	684	685	686	687	688	689	690	691	692	693	694	695	696	697	698	699	700	701	702	703	704	705	706	707	708	709	710	711	712	713	714	715	716	717	718	719	720	721	722	723	724	725	726	727	728	729	730	731	732	733	734	735	736	737	738	739	740	741	742	743	744	745	746	747	748	749	750	751	752	753	754	755	756	757	758	759	760	761	762	763	764	765	766	767	768	769	770	771	772	773	774	775	776	777	778	779	780	781	782	783	784	785	786	787	788	789	790	791	792	793	794	795	796	797	798	799	800	801	802	803	804	805	806	807	808	809	810	811	812	813	814	815	816	817	818	819	820	821	822	823	824	825	826	827	828	829	830	831	832	833	834	835	836	837	838	839	840	841	842	843	844	845	846	847	848	849	850	851	852	853	854	855	856	857	858	859	860	861	862	863	864	865	866	867	868	869	870	871	872	873	874	875	876	877	878	879	880	881	882	883	884	885	886	887	888	889	890	891	892	893	894	895	896	897	898	899	900	901	902	903	904	905	906	907	908	909	910	911	912	913	914	915	916	917	918	919	920	921	922	923	924	925	926	927	928	929	930	931	932	933	934	935	936	937	938	939	940	941	942	943	944	945	946	947	948	949	950	951	952	953	954	955	956	957	958	959	960	961	962	963	964	965	966	967	968	969	970	971	972	973	974	975	976	977	978	979	980	981	982	983	984	985	986	987	988	989	990	991	992	993	994	995	996	997	998	999	1000	1001	1002	1003	1004	1005	1006	1007	1008	1009	1010	1011	1012	1013	1014	1015	1016	1017	1018	1019	1020	1021	1022	1023	1024	1025	1026	1027	1028	1029	1030	1031	1032	1033	1034	1035	1036	1037	1038	1039	1040	1041	1042	1043	1044	1045	1046	1047	1048	1049	1050	1051	1052	1053	1054	1055	1056	1057	1058	1059	1060	1061	1062	1063	1064	1065	1066	1067	1068	1069	1070	1071	1072	1073	1074	1075	1076	1077	1078	1079	1080	1081	1082	1083	1084	1085	1086	1087	1088	1089	1090	1091	1092	1093	1094	1095	1096	1097	1098	1099	1100	1101	1102	1103	1104	1105	1106	1107	1108	1109	1110	1111	1112	1113	1114	1115	1116	1117	1118	1119	1120	1121	1122	1123	1124	1125	1126	1127	1128	1129	1130	1131	1132	1133	1134	1135	1136	1137	1138	1139	1140	1141	1142	1143	1144	1145	1146	1147	1148	1149	1150	1151	1152	1153	1154	1155	1156	1157	1158	1159	1160	1161	1162	1163	1164	1165	1166	1167	1168	1169	1170	1171	1172	1173	1174	1175	1176	1177	1178	1179	1180	1181	1182	1183	1184	1185	1186	1187	1188	1189	1190	1191	1192	1193	1194	1195	1196	1197	1198	1199	1200	1201	1202	1203	1204	1205	1206	1207	1208	1209	1210	1211	1212	1213	1214	1215	1216	1217	1218	1219	1220	1221	1222	1223	1224	1225	1226	1227	1228	1229	1230	1231	1232	1233	1234	1235	1236	1237	1238	1239	1240	1241	1242	1243	1244	1245	1246	1247	1248	1249	1250	1251	1252	1253	1254	1255	1256	1257	1258	1259	1260	1261	1262	1263	1264	1265	1266	1267	1268	1269	1270	1271	1272	1273	1274	1275	1276	1277	1278	1279	1280	1281	1282	1283	1284	1285	1286	1287	1288	1289	1290	1291	1292	1293	1294	1295	1296	1297	1298	1299	1300	1301	1302	1303	1304	1305	1306	1307	1308	1309	1310	1311	1312	1313	1314	1315	1316	1317	1318	1319	1320	1321	1322	1323	1324	1325	1326	1327	1328	1329	1330	1331	1332	1333	1334	1335	1336	1337	1338	1339	1340	1341	1342	1343	1344	1345	1346	1347	1348	1349	1350	1351	1352	1353	1354	1355	1356	1357	1358	1359	1360	1361	1362	1363	1364	1365	1366	1367	1368	1369	1370	1371	1372	1373	1374	1375	1376	1377	1378	1379	1380	1381	1382	1383	1384	1385	1386	1387	1388	1389	1390	1391	1392	1393	1394	1395	1396	1397	1398	1399	1400	1401	1402	1403	1404	1405	1406	1407	1408	1409	1410	1411	14

SHIPPING CONTAINER TALLY → 1 2 3 4 5 6 7 8 9 10 11 12 13 14 15 16 17 18 19 20 21 22 23 24 25 26 27 28 29 30 31 32 33 34 35 36 37 38 39 40 41 42 43 44 45 46 47 48 49 50

REQUISITION AND INVOICE / SHIPPING DOCUMENT										Form Approved OMB No. 0704-0248 Expires Oct 31, 1997										
Public reporting burden for this collection of information is estimated to average 15 minutes per response, including the time for reviewing instructions, searching existing data sources, gathering and maintaining the data needed, and completing and reviewing the collection of information. Send comments regarding this burden estimate or any other aspect of this collection of information, including suggestions for reducing the burden, to Washington Headquarters Services, Directorate for Information Operations and Reports, 1215 Jefferson Davis Highway, Suite 1204 Arlington, VA 22202-4302, and to the Office of Management and Budget, Paperwork Reduction Project (0704-0248), Washington, DC 20503										SHEET NO 01		NO OF SHEETS 01		REQUISITION DATE 15OCT1995		REQUISITION NUMBER R52192-5015				
1. FROM (Include ZIP Code) R52192 USS UNDERWAY (CVN 82) FPO AE SAN FRANCISCO 12345-6789										7. DATE MATERIAL REQUIRED (YYMMDD) 30JAN1996		8. PRIORITY 13								
2. TO (Include ZIP Code) N00244 FISC SAN DIEGO, CA										9. AUTHORITY OR PURPOSE		10. SIGNATURE W. T. DOOR, LT, SC, USN		11. VOUCHER NUMBER & DATE (YYMMDD)						
3. SHIP TO-MARK FOR SUPPLY OFFICER USS UNDERWAY (CVN 82) FPO AE SAN FRANCISCO 12345-6789										12. DATE SHIPPED (YYMMDD)		13. MODE OF SHIPMENT		14. BILL OF LADING NUMBER		15. AIR MOVEMENT DESIGNATOR OR PORT REFERENCE NO				
4. APPROPRIATIONS SYMBOL AND SUBHEAD FUND CODE NU										OBJ. CL.	BLR. CONT. NO.	BUS. LET.	AUTHORIZATION ACCTG. ACTIVITY	TRANS. TYPE	PROPERTY ACCTG. ACTIVITY	COL. TRF.	COST CODE	AMOUNT		
ITEM NO. (4)	FEDERAL STOCK NUMBER, DESCRIPTION, AND CODING OF MATERIAL AND/OR SERVICES (6)							UNIT OF ISSUE (K)	QUANTITY REQUESTED (N)	SUPPLY ACTION (M)	TYPE CON. TAINER (R)	CON. TAINER NOS. (S)	UNIT PRICE (P)	TOTAL COST (4)						
1	CHYRON CHARACTER GENERATOR MODEL VP2 Ser. No. 21B2982664							EA	0001				7025.00	7025.00						
UPON RECEIPT PLEASE SEND A SIGNED COPY TO:										SUPPLY OFFICER USS UNDERWAY (CVN 82) FPO AE SAN FRANCISCO 12345-6789 ATTN: CP DIVISION										
16. TRANSPORTATION VIA MATS OR MATS CHARGEABLE NO										17. SPECIAL HANDLING										
RECEIPT DATE INITIALS SIGNATURE	ISSUED BY		TOTAL CON-TAINER	TYPE CON-TAINER	DESCRIPTION			TOTAL WEIGHT	TOTAL CUBE	CONTAINERS RECEIVED EXCEPT AS NOTED		DATE (YYMMDD)	BY	SHEET TOTAL						
	CHECKED BY									QUANTITIES RECEIVED EXCEPT AS NOTED		DATE (YYMMDD)	BY	GRAND TOTAL						
	PACKED BY									POSTED		DATE (YYMMDD)	BY	30. RECEIVER'S VOUCHER NO						
					← TOTAL →															

DD Form 1149, MAR 89 51 52 53 54 55 56 57 58 59 60 61 62 63 64 65 66 67 68 69 70 71 72 73 74 75 76 77 78 79 80 81 82 83 84 85 86 87 88 89 90 91 92 93 94 95 96 97 98 99 100  
S/N 0902 L F 007 2300 Previous editions are obsolete (Heavy Overprint 1989)

46NVJ090 ORIGINAL

Figure 5-11.—DD Form 1149.

**MATERIAL OBLIGATION VALIDATION (MOV) REQUEST.** The MOV request is from the supply source to a requisitioner. It is to confirm that the requisitions held on back order by the supply source are comparable with those carried as outstanding by the requisitioner. It is extremely important to respond to an MOV request. If an MOV request is neglected, the items listed are to be canceled.

**MATERIAL OBLIGATION VALIDATION (MOV) RESPONSE.** The MOV response is a reply by the requisitioner to an MOV request from the supply source. It advises the supplier to hold a back order until supplied, cancel a back order, or reduce the item quantity listed.

**CANCELLATION.** A total or partial discontinuance of supply action requested by the requisitioner and confirmed by the supplier.

**CHARGEABLE ACTIVITY.** The activity that is charged for the cost of operation regardless of the funds used.

**EXCEPTION STATUS.** This is a supply action, other than issue of material, in the quantity requested.

**FOLLOW-UP.** An inquiry by the requisitioner to the last known holder of a requisition as to the action taken on that requisition.

**FOLLOW-UP REPLY.** Current status by the holder of the requisition. This is in response to a follow-up.

**FORCE/ACTIVITY DESIGNATOR (F/AS).** A Roman numeral designator established by each military service (or the Joint Chiefs of Staff) that relates to the military mission of the force or activity.

**STANDARD DELIVERY DATE (SDD).** The standard delivery date is based on the priority

designator of the requisition. It is the latest date that the supply system is expected to make delivery of the material to the requisitioner.

**REQUISITIONER.** The requisitioner can be any Navy activity, afloat or ashore, with a unit identification code (UIC) assigned by the *NAVCOMPT Manual*, Volume 2, Chapter 5, "Requisitioning Material from a Supply Source."

**SHIPMENT STATUS.** The shipment status pertains to positive advice of shipment and indicator of shipment, date and mode of shipment, and transportation control number or bill of lading number, when applicable.

**STATUS CODES.** Status codes are used by supply sources to furnish information on the status of requisitions to the requisitioner or consignee.

**100-PERCENT SUPPLY STATUS.** One-hundred-percent supply status relates to any positive or negative supply distribution decision or action at any level; that is, any action taken by the supplier including issue of material in the exact quantity requested.

You can see there is an extensive use of codes in MILSTRIP requisitioning (fig. 5-8). This is necessary because only 80 alphabetic or numeric characters (letters and numbers) can be placed on the card (this does not include the activity names shown in data blocks A and B). It is essential for you to select the correct code that conveys the proper information to the supplier. The correct codes are just as important on a requisition as the correct NSN.

## UMMIPS

The Uniform Material Movement and Issue Priority System (UMMIPS) is a vital and integral part of the MILSTRIP system. MILSTRIP provides forms and procedures for requisitioning material, and UMMIPS provides the method of assigning priorities for issuing and moving material.

UMMIPS ensures that material issue requests are processed according to military IMPORTANCE and the URGENCY of needs by the requiring activity. The relative importance of completing demands for logistic system resources, such as transportation, warehousing, requisition processing, and material assets, must be identified before material can be issued and moved. The relative importance and urgency of logistic requirements are indicated by two-digit issue priority designators.

## Force/Activity Designator

A Force/Activity Designator (F/AD) is a Roman numeral (I through V) that identifies and categorizes a force or activity on the basis of its military importance. The assignment of an F/AD is shown in NAVSUP P-485.

## Urgency of Need Designator

The Urgency of Need Designator (UND) is an uppercase letter of the alphabet (A, B, or C) selected to indicate the relative urgency of a force or need of an activity for a required item of material. The assignment of an UND is the responsibility of the force or activity that requires the material.

UND	Definition
A.	Requirement is immediate.
	Without the material needed, the activity is unable to perform one or more of its primary missions.
B.	Requirement is immediate, or it is known that such requirement will occur in the immediate future.
	The ability of the activity to perform one or more of its primary missions is impaired until the material is received.
C.	Requirement is routine.

A. Requirement is immediate.

Without the material needed, the activity is unable to perform one or more of its primary missions.

B. Requirement is immediate, or it is known that such requirement will occur in the immediate future.

The ability of the activity to perform one or more of its primary missions is impaired until the material is received.

C. Requirement is routine.

## Issue Priority Designator

An Issue Priority Designator (IPD) is a two-digit number (01 highest to 15 lowest). You can determine an IPD by using the table of priority designators (table 5-2).

Table 5-2.—F/AD and UND Priority Designators

F / AD AND UND <sub>6</sub> PRIORITY DESIGNATORS					
URGENCY OF NEED DESIGNATOR	F / AD				
	I	II	III	IV	V
PRIORITY DESIGNATORS					
A ( UNABLE TO PERFORM )	01	02	03	07	08
B ( PERFORMANCE IMPAIRED )	04	05	06	09	10
C ( ROUTINE )	11	12	13	14	15

For example, if your ship is assigned an F/AD of III and your requirement is of a routine nature, the priority to be assigned would be 13.

In addition to providing standardized criteria for assigning priorities, UMMIPS provides acceptable maximum processing times for use by supply activities in furnishing material. Pressing time standards and additional codes used in MILSTRIP and UMMIPS are included in NAVSUP P-485. Table 5-2 shows how the F/AD, the UND, and the IPD are assigned.

## **PROCUREMENT PROCEDURES**

There are a number of sources of information for filling out the DD Form 1348. Several publications are available, either in your unit or your servicing supply department, to furnish specific procedures and notices regarding the supply system.

### **Naval Supply Systems Command Publication 437**

The NAVSUP P-437 promulgates policy and procedures relative to the Military Standard Requisitioning and Issue Procedures and the Military Standard Transaction Reporting and Accounting Procedures (MILSTRIP/MILSTRAP). This publication covers MILSTRIP/MILSTRAP relative to supply system management, requisitioning ashore, inventory control, financial matters, material movement, priorities, and evaluation procedures. This publication provides forms, formats, codes, and serves as a comprehensive ready reference for those involved in the preparation or processing of MILSTRIP documents.

NAVSUP P-437 is not distributed afloat. All afloat MILSTRIP/MILSTRAP procedures are incorporated into the NAVSUP P-485.

### **MILSTRIP/MILSTRAP Desk Guide (NAVSUP P-409)**

Since NAVSUP P-437 is a comprehensive publication, filling three 2-inch binders, the *MILSTRIP/MILSTRAP Desk Guide*, NAVSUP P-409, is published to serve as a handy reference for originating and processing MILSTRIP and MILSTRAP documents. This small booklet contains those common definitions, coding structures, and abbreviated code definitions used on a day-to-day basis.

## **Fleet Use of MILSTRIP (NAVSUP P-410)**

NAVSUP P-410 serves the same purpose as the Desk Guide (NAVSUP P-409) and is designed for use by fleet personnel. It is also used for the purpose of indoctrination and training of fleet personnel in MILSTRIP.

## **SPECIAL REQUISITIONING INFORMATION**

Thus far, you have learned how requisitions are prepared and submitted for routine requirements. However, not all requisitions are routine. For some, special handling or additional information is required.

### **Servmart and Seamart**

SERVMART and SEAMART are convenient sources of material that permit the use of a single money value only (MVO) requisition to procure several stock items. SERVMART and SEAMART are located at most naval bases and ships, respectively. They are arranged in a supermarket concept.

When it is appropriate to obtain material from a SERVMART or SEAMART, an MVO, DD Form 1348, or DD Form 1250/9-1 must be prepared. Each of the following categories of material is listed on a separate form when SERVMART shopping lists (SSLs) are used:

- Consumable items
- Repair parts
- Equipage

Each SERVMART and SEAMART prepares a shopping guide to assist you in preparing requisitions. The shopping guide lists all of the items that are stocked. These guides are provided to all ships and activities in the area.

Upon receipt of an internal request, a requisition form is prepared to cover the monetary value, and the original copy of DD Form 1348 is given to the person authorized to pick up the material.

### **Transfers from Other Ships and Activities**

Emergency requirements may be obtained from ships other than supply ships and tenders, providing the material is available and can be spared. The request



may be made on DD Form 1348 or by message. The request should contain the same information as a requisition to a supply activity except for the routing identifier, which is left blank. When the material requested is not available for issue, the requisition is returned to the originator. Ships do not hold requisitions on back order for later issue.

### **Forms and Publications**

Forms are requisitioned on DD Form 1348 in the same manner as any other consumable material. Publications (identified by cognizance symbol 01) are not carried in a stores account and are issued without charge.

Special requisitioning instructions, approval requirements, and restrictions are indicated in the requisition restriction (RR) column of the *Navy Stock List of Forms and Publications*.

NAVSUP Form 1205 must be used to order Navy departmental directives. There is no cost for these directives. The form is preaddressed to the Aviation Supply Office (ASO) and may be placed in a window envelope for mailing after it (including the return address label) has been filled out.

### **Requisition Follow-up**

When material or status has not been received by the standard delivery date (SDD) or the required delivery date (RDD), you should submit a follow-up to determine the shipping status. The standard delivery date is computed by adding the authorized UMMIPS delivery time to the Julian date of your requisition. The follow-up may be submitted on DD Form 1348 (2-PT).

The document identifier AF1 and the routing identifier for the last known holder of the requisition are assigned. The balance of the follow-up is identical to the original requisition unless part of the material has already been received.

When you are taking action on a requisition for urgently needed material and the SDD or RDD is past due with no follow-up status received, document identifier AT may be used instead of AF1. This tells the supply activity to process the follow-up as a requisition if they do not have the original requisition. This could preclude the need for another requisition if response to an AF1 follow-up is "no record of your requisition." On the other hand, it may also result in duplicate shipment and billing.

### **Requisition Cancellation**

When material has been requisitioned but not received and is no longer required, you should send a cancellation request to the last known holder of the requisition. The requisition should be prepared in the same manner as a follow-up with a document identifier in the AC series. Submission of a cancellation request does not guarantee cancellation of the requisition. If the supply activity has already released or shipped the material, the requisition cannot be canceled. For this reason, you should not consider a requisition canceled until confirmation is received from the supply activity.

### **Open Purchase**

Open-purchase actions are taken by a shore activity as a result of emergency requirements for supplies or services by purchase on the open market when all of the following conditions exist:

1. There is an immediate and urgent requirement for authorized supplies or services.
2. The supplies or services are not available at the local supply support activity.
3. Scheduled operations will not permit the time to procure supplies through the regular Navy Supply System.

The supply officer may make routine purchases of supplies and services when all of the following conditions exist:

1. The supplies or services are not available at the local supply support activity.
2. Supply department resources are sufficient to handle the additional work load involved without detrimental effects.
3. Transactions are made by an approved small-purchase method that provides for immediate delivery of the material.

### **Methods Of Purchase**

Purchases are made by one of the following methods:

1. By purchase order for purchases of \$2,500 or less.
2. By imprest fund for cash purchases of \$150 or less (\$300 under emergency conditions).
3. By orders under indefinite delivery types of contracts.

4. By blanket purchase agreements (BPAs) negotiated by ashore activities. This type of purchase is most commonly used.

Details concerning purchases by ashore activities are provided in NAVSUP P-467.

### **Imprest Funds**

The imprest fund is a simple and economic method of making purchases. It is both a petty cash and a revolving type of fund. The fund is reduced as purchases are made. A reimbursement voucher must be prepared at some point in time. The ship's OPTAR is charged for the amount of the reimbursement voucher, and the money is returned to the imprest fund. Most shipboard activities discourage the use of imprest funds.

## **STOWAGE**

The supply petty officer is responsible for stowing materials properly and for protecting them from damage and deterioration while in stowage.

Photographic materials in both shipboard and shore storerooms should be arranged to do the following:

1. Ensure maximum use of available space.
2. Provide orderly stowage and ready accessibility.
3. Prevent damage to the ship, facility, or injury to personnel.
4. Reduce the possibility of material loss or damage.
5. Facilitate issues and inventories.

### **STOREROOM LAYOUT**

Space permitting, you should adhere to the following guidelines when stowing supplies and equipment:

1. Locate heavy bulk materials in areas most convenient to hatches, doors, and material-handling equipment. This minimizes the physical effort required for loading, stowage, and breakouts.
2. Locate light bulky material in storerooms with high overhead clearances for maximum use of available space.
3. Segregate materials that are dissimilar in type or classification, such as hazardous and nonhazardous, classified and unclassified, and large and small materials.

4. Locate materials that are issued frequently as close as possible to the point of issue.

5. Locate shelf-life items (film, paper, and so on) in a readily accessible area to facilitate periodic screening.

6. Provide for aisles at least 30 inches wide between bins, racks, or cabinets.

7. Arrange materials so identification labels are facing outward to facilitate issues and inventory.

8. Avoid multiple locations for the same item.

## **HAZARDOUS MATERIAL**

Hazardous material includes all types of compressed gases, acids, paints, and materials that present a considerable fire hazard or are otherwise dangerous. Except as indicated below, these materials must be stowed in paint and flammable liquid storerooms.

### **Compressed Gases**

Compressed gases must be stowed on the weather deck or outdoors and fastened securely in a vertical position. Cylinder valves should be protected from accumulations of ice and snow, and the cylinders should be screened from direct rays of the sun.

### **Acid**

Liquid acid, unless classified as a safe material, should be stowed in lead-lined boxes.

## **SECURITY**

Storerooms should be locked when not in use. Ordinarily, only the supply petty officers in charge of a storeroom and authorized assistants have access to the storeroom, and one of them must be present when the storeroom is open. Other persons may be admitted when necessary during receipt or issue of stores.

Access must be given to damage control and fire department personnel in the performance of their duties. Storerooms must be secured so ordinary damage control and emergency equipment can clear the entranceway.

## **STOCK CONTROL**

The primary function of stock control is to ensure that materials are available in the proper amount, at the proper place, and at the proper time. To accomplish



5. Received from/Issued to: All receipts are entered in red ink; all issues are entered in black ink.

6. Reportable demand: The quantity expended that must be replaced for continued operations.

7. Other issues/receipts: Nonreplenishment issues and receipts; for example, items that are not consumable.

8. Balance: The amount remaining after issues and receipts.

**Stock Record Card Insert**

A Stock Record Card Insert (NAVSUP Form 768) (fig. 5-13) contains information pertaining to a

particular stock item and serves as an index to the Stock Record Card (fig. 5-12). The information necessary for completing this card is located in various publications mentioned.

**Stock Status and Replenishment Card**

A Stock Status and Replenishment Card (NAVSUP Form 767) is maintained for each item in stock and serves a dual purpose (fig. 5-14). The left side of the card is used to assemble stock status data preparatory to replenishment action and serves as a historical record of such data. The right portion of the card is divided

UNIT	EA	UNIT PRICE	5.79	LOCATION BUILDING	N0012	FLOOR LEVEL		BAY		BIN OR SHELF	N001	LOW PLANT	6
PACKAGING				SUBSTITUTES									
DESCRIPTION				ITEMS INTER-CHANGEABLE WITH				BASKET, WASTEPAPER					
QBL CQGL	9G	STOCK NUMBER	00-281-5911	NOMENCLATURE	BASKET	EXHAUSTED	LOW LIMIT	ORDERED	EXCESS	NEW	UNIT	UNIT PRICE	QBL
<p>TABULATING MACHINE USERS PLEASE NOTE - Print cognizance letter, stock number, and nomenclature in sequence indicated.</p> <p>STOCK RECORD CARD INSERT</p>													
												46NVJ093	814750-989

Figure 5-13.—Stock Record Card Insert (NAVSUP Form 768).

STOCK NO. 1RM1650-00-232-4114AA							STOCK NO. 1RM1650-00-232-4114AA						
ACCOUNT NSA							ACCOUNT NSA						
CARD NO. 2							CARD NO. 2						
STOCK STATUS DATA							STATUS OF EXPECTED RECEIPTS						
REP. PERIOD ENDING	REPORTABLE DEMAND	TOTAL OUTSTANDING OBLYS	PLANNED RECEIPTS	BALANCE ON HAND	EXPECTED RECEIPTS DUE	REQUIRED OR EXCESS	DATE	EXPECTED REC'PT DOC NO	QUANTITY	DATE	RECEIPT DOC	QUANTITY	BAL ON ORDER
16/94	16	0	0	20	0	28	4/3/94	6007	28	4/3/94		28	—
29/94	14	0	0	34	0	8	4/8/94	9010	8	4/10/94		8	—
42/94	20	0	0	14	8	38	4/14/94	2100	38	4/20/94		8	30
3/95	26	4	0	0	38	44	5/23/95	3004	44	4/25/94		30	—
16/95	42	6	44	0	44	132							
STOCK STATUS AND REPLENISHMENT CARD (4442) NAVSUP Form 767 Rev. (8-60)							S/N 0108 - LF - 502 0102						
46NVJ094													

Figure 5-14.—Stock Status and Replenishment Card (NAVSUP Form 767).

into two sections: ordered and received. It serves as a record of replenishment actions and shows the status of all expected receipts.

A Stock Status and Replenishment Card contains the following information on the left side:

1. Stock number: Obtained in the same manner as the stock number on the stock record card.

2. Account: Either APA or NSA, as appropriate.

3. Card number: Obtained in the same manner as indicated for a stock record card.

4. Replenishable period ending: The end of the quarter. The upper number indicates number of the week; the lower number indicates the year; for example, 16/95.

5. Reportable demand: The replenishment demand or amount expended for the preceding period.

6. Total outstanding obligations: Definite obligations for supplying other activities and definite obligations needed for an increase in work load.

7. Planned requirement: Estimated amounts needed to supply other activities and estimated amounts needed for an increase in work load.

8. Balance on hand: The amount remaining in stock after issues.

9. Expected receipts due: Items that are on order.

10. Required or excess: Amount to order or amount in excess of that which is needed (any excess amount is circled). To determine the amount of excess or required material, you may use the following method:

a. Determine the amount required for the next quarter. Add reportable demand to total outstanding obligations.

b. Add balance on hand to expected receipts.

c. Determine the amount by subtracting the second total from the first total. If the second total is greater than the first total, there is an excess. Material should not be ordered.

The following information is provided on the right side (Status of Expected Receipts, Ordered):

1. Date: The Julian date that the requisition was submitted.

2. Expected receipt document No.: The requisition number of the item on order.

3. Quantity: The amount ordered.

The following information is provided on the right side (Status of Expected Receipts, Received):

1. Date: Julian date that the material was received.

2. Receipt document: If different from ordered receipt document number.

3. Quantity: If different from ordered quantity.

4. Balance on order: Amount not yet received. (In case the order has been cut or split, there are four lines per order for this purpose.)

A Stock Status and Replenishment Card is usually placed in the same Cardex File pocket, with and under, the Stock Record Card for a particular item.

### **Stock Record Card Afloat**

A Stock Record Card Afloat (NAVSUP Form 1114 [1C]) is maintained aboard ships operating under manual stock control procedures (fig. 5-15). This form may be prepared by hand or typed according to the format printed on the form. Identifying information must be inserted on the top and bottom lines of the form.

The Stock Record Card Afloat provides for replenishment actions, material receipts, and material expenditures. It also reflects a running balance of stock on hand.

As requisitions are prepared, they are posted to the "requisitions outstanding" block of NAVSUP Form 1114. The Julian date of the requisition, the document number, and the quantity ordered should be entered in the appropriate columns.

### **High and Low Limits**

To ensure that your unit has, at all times, a well-rounded stock of material to sustain operations, you must perform effective stock management.

The terms *high* and *low limits* identify the maximum and minimum levels of stock required to support the mission of your unit.

The high limit of a stock item is synonymous with the requisitioning objective; that is, the safety level, plus the operating level, plus the quantity that is normally required during the ordering and shipping time. A high limit is not assigned to items of stock in quantities of two or less.

9N	5960-00-193-5145 TUBE			EA	60	06302342	D1119	13	10	
DOG	FR	STOCK NO. AND DESCRIPTION			U/I	UNIT PRICE	ALLOWANCE PARTS LIST	LOCATION	HIGH LIMIT	LOW LIMIT
V03864		6 1 R 3/7			1/3/68-					
REQUISITIONS OUTSTANDING		ALL /LL QTY	AT	TSHC	EL	URIS	INCLUSIVE DATES OF DEMAND	DEMANDS BR. FWD.	FREQ. BR. FWD.	MIL. ESSENT.
DATE	DOCUMENT NO.	QUANTITY	DATE / DOCUMENT NO.	RECEIPTS	ISSUES	ON HAND	DATE / DOCUMENT NO.	RECEIPTS	ISSUES	ON HAND
<del>3008</del>	<del>3015</del>	<del>6</del>	<del>3003</del>			6	<del>3100</del>	<del>1503</del>	4	7
<del>3009</del>	<del>3307</del>	<del>10</del>	<del>3008</del>	0916	6	0				
<del>3112</del>	<del>3579</del>	<del>6</del>	3011	3015	6	6				
			3091	1117		3				
			3102	3307	10	13				
			3112	1251		6			7	
			3130	3579	6	13				
			3152	1460		2			11	
DOG	FR	STOCK NO. AND DESCRIPTION			U/I	UNIT PRICE	ALLOWANCE PARTS LIST	LOCATION	HIGH LIMIT	LOW LIMIT
9N		5960-00-193-5145 TUBE			EA	60	06302342	D1119	13	10

46NVJ095

Figure 5-15.—Stock Record Card Afloat (NAVSUP Form 1114 [1C]).

The low limit of a stock item is the safety level plus the quantity of material expected to be consumed during the order and shipping time. The low limit entry for items in which stock is maintained at two or less is the total quantity. Replenishment is initiated each time an issue is made.

### Stock Record Replenishment Review

Stock records are reviewed at the time receipts and expenditures are posted. The balance on hand is checked visually against the low limit. Items approaching or at the low limit are flagged to indicate that replenishment is required at the earliest opportunity. Replenishment requisitions are prepared and submitted to the designated supply point. The material should be ordered in sufficient quantities to bring the material on hand and on order up to the high limit.

Established high and low limits may have to be adjusted from time to time as usage data indicates. Table 5-3 shows an example of how high and low limits are determined.

Table 5-3 is based on a stock item with a past usage rate of 100 each per month.

In addition, when a ship or unit receives orders to deploy, the stock records are reviewed to ensure that stock is replenished as near to the high limit as possible.

Particular attention should be paid to stock records of critical items. They should be flagged appropriately to remind you to review and replenish them frequently. The following categories of items are critical, relative to replenishment review procedures:

- Fast-moving items with lower safety levels than desired because of stowage limitations or shelf life

Table 5-3.—Determining Quantity Levels of Supply

Level of Supply	Months	Appropriate Quantity
1. Safety level	2	200
2. Operating level	6	600
3. Stocking objective (1 + 2)	8	800
4. Order and shipping time	1	100
5. Requisitioning level or high limit (3 + 4)	9	900
6. Low limit (1 + 4)	3	300

- All items that can seriously impair operations if they run out

## REQUISITION LOGBOOK

The Requisition Logbook accomplishes two purposes: First, it serves as a ready reference for material on order; and second, it serves as a record of material received. This book should have columns for the requisition number, stock number, nomenclature, quantity ordered, unit price, total cost, date ordered, date received, local supply department requisition number, and amount received. These columns can be varied to meet local needs.

## FILES

Piles must be maintained to hold documents that relate to prospective material receipts and which, upon receipt of the material, are used to ease the receiving process. Piles are also required to hold the documents after they are processed to provide records of receipt.

### Material Outstanding File

The material outstanding file contains a copy of each procurement document for material and services not yet received. The file also includes, as attachments to individual procurement requests, related documentation, such as follow-ups, supply status, and shipping status.

### Material Completed File

The material completed file contains a copy of each procurement document that has been removed from the material outstanding file once the material is received or canceled. It also contains a copy of each applicable receipt document.

NOTE: Because of the volume of business and numerous customers at any supply department, matters requiring follow-up on outstanding requisitions are handled more efficiently when you know the supply requisition number.

## INVENTORY

The term *inventory*, as used by Photographer's Mates, applies to the actual number of items physically within the imaging-facility spaces and under the control of the imaging-facility manager or officer.

Inventory aboard ship is necessary to ensure that ships have a well-rounded stock of materials on board to sustain operations for a maximum period of time. To do this, you must maintain effective inventory procedures for all items in stock.

Physical inventories must be performed to verify the accuracy of stock records and to adjust the stock records when discrepancies are found. Briefly, periodic inventories are taken for the following reasons:

- To determine quantities of stock on hand for comparison with stock record card balances
- To determine the difference between actual physical count and stock record card balances
- To verify the causes of these differences
- To provide data to help prevent future discrepancies

The most important aspect of physical inventory is to ensure that material presumed to be in stock is actually present and available for issue when needed. The false security created by an erroneous balance on the stock record card is serious. A zero balance, for instance, may be rectified by timely procurement action; however, when the zero balance is not known and there is a demand for the material, a serious problem exists.

NOTE: When taking inventory in a storeroom, you must use the correct NSN or the count will be posted to the wrong card. To help prevent errors in inventory and issues, you should mark all stock in the storerooms with an NSN. This may be done by placing a stock tag on the bin or drawer front when only one type of material is stowed therein, by fastening a stock tag to the item, or by writing the NSN on the item. It takes a little time to mark stock properly when it is inventoried or received, but it can save you a lot of time later on.

### Imaging Equipment and Material

You might think of your responsibilities as a supply petty officer as being a circle formed by a chain with each link representing a specific job. Each link is dependent on others. When the procurement documents are prepared properly, the receiving procedure is relatively simple. As the "storekeeper" for an imaging facility, you are responsible for the receipt, identification, inspection, and distribution of incoming supplies and equipment. Two terms you should





the *Navy Visual Information Management and Operations Manual*, OPNAVINST 5290.1.

The term *custody* indicates the responsibility for proper care, stowage, and use of Navy material. The manager or officer of the imaging facility is responsible for all supplies stocked in an imaging facility. When the supplies are stowed in storerooms, the photo officer has technical custody of the material. As the supply petty officer, you have actual custody (physical custody) of the material. As such, you have subcustody of materials in the storeroom(s). You are also responsible to the photo officer for its safekeeping.

### Plant Property

The term plant property is used to describe Navy-owned real property and other types of property in the care of the Navy.

All plant property items are divided into four classes as follows:

Class 1—land

Class 2—buildings and improvements

Class 3—equipment (other than industrial production equipment)

Class 4—industrial production equipment

As a Photographer's Mate, you will be most concerned with Class 3—equipment. Some examples are typewriters, adding machines, and enlargers. Remember, custody records must be maintained for this material throughout its useful life.

### Custody Cards

For each item of controlled equipment requiring custody signature, you must have a Controlled-Equipage Custody Record (4442), NAVSUP Form 306 and NAVSUP Form 460 (figs. 5-16 and 5-17). Both cards are referred to as "custody cards." Each card is signed by the appropriate authority for custody after having sighted the item identified on the card. NAVSUP Form 306 is punched to fit into a three-ring binder. NAVSUP Form 460 fits into the pocket of a Cardex File.

The original and at least one copy of the custody card is prepared for each item of equipment requiring

<i>(Card No.)</i>	<i>(Department)</i>	<i>(FSN/Part No.)</i>	<i>(Noun name)</i>	<i>(Allowance)</i>	<i>(U/I)</i>	<i>(A/L No. - Page-Line)</i>	<i>(Unit price)</i>
<b>CONTROLLED-EQUIPAGE CUSTODY RECORD (4442)</b>						CUSTODY SIGNATURE REQUIRED <input type="checkbox"/> YES <input type="checkbox"/> NO	
<b>TRANSACTION RECORD</b>						<b>INVENTORY RECORD</b>	
DATE	DOCUMENT NO.	RECD FROM/EXPEND TO	RECD.	EXPEND.	BALANCE	I acknowledge custody of this item in the quantity indicated.	
						DATE	QTY
						BY	
						DATE	QTY
						BY	
						DATE	QTY
						BY	
						DATE	QTY
						BY	
O/S REQ'D (No.)		(Qty.)		O/S REQ'D (No.)		(Qty.)	
SERIAL NO.							
ADDL DESCRIPTION							
CARD NO.	DEPARTMENT	FSN/PART NO.	NOUN NAME	ALLOWANCE	U/I	A/L NO. PAGE:	LINE: UNIT PRICE
STOCK NO. 0108-501-0802							
46NVJ097							

Figure 5-17.—NAVSUP Form 460.)

custody signature. The original is maintained by the supply officer or the department head. When the supply officer maintains the original, the department head usually signs the custody card. Most imaging units have the original custody cards maintained by the department head, and the originals are signed by the division officer assuming subcustody.

Duplicate copies of custody cards are usually maintained by the supply petty officer for subcustody purposes. When an item of equipment is issued to a crew member or subcustody, the crew member must sign the duplicate copy of the custody card. Equipment that is installed permanently, such as enlargers and processors, should be issued on subcustody to the petty officer in charge of the work section where the equipment is located.

The duplicate copy of the custody card is also used for inventory purposes. The card must be signed by the person conducting the inventory. The original custody card needs to be signed only once by the person having custody of the item. The original custody card should not be signed each time an inventory is conducted; however, the original custody card must be signed by the relieving authority after sighting the item.

### **Inventory of Controlled (Custody) Equipage**

All items of controlled equipage must be inventoried. The frequency of controlled-equipage inventory is at the discretion of each individual command; however, inventories of controlled equipage are required when any of the following situations occur:

- The ship, station, or unit is commissioned, inactivated, or reactivated.
- The department head is relieved or transferred.
- Upon change of command, at the discretion of the relieving commanding officer.

NOTE: Although not specifically required, an inventory should be conducted whenever the imaging-facility manager, photo officer, or supply petty officer is relieved or transferred.

A Controlled-Equipage Custody Record (4442), NAVSUP Form 306 or NAVSUP Form 460, should be used to conduct the controlled-equipage inventory. Each article should be sighted and inspected for serviceability by the person making the inventory.

When an inventory is conducted, articles should be identified and verified by serial number or plant-account number.

As the inventory progresses, the person conducting the inventory signs the custody record acknowledging custody or inventory, as appropriate, of all the items sighted. Equipage inventories must be completed within 30 days after it has begun. When taken jointly by the department head being relieved and the relieving department head, for example, the inventory must be completed before the outgoing department head detaches from the activity.

Once the equipage inventory is completed, the department head must submit a letter to the commanding officer with a copy to the supply officer. Whenever possible, the letter should be a joint report from both the relieved and relieving department head with both signatures. The report should include the following information:

- The department equipage inventory has been completed.
- All requests for surveys that are submitted for shortages and unserviceable items found during the inventory.

Any shortages or unserviceable items found during the inventory must be identified in a **Report of Survey** (DD Form 200) or **Missing, Lost, Stolen, or Recovered Government Property** (OPNAV Report 5500-1), as appropriate.

### **MISSING, LOST, STOLEN, OR RECOVERED GOVERNMENT PROPERTY**

The Navy recognizes the importance of maintaining statistics to determine where, when, and how Navy property became missing, lost, or stolen. Based on this premise, Missing, Lost, Stolen, or Recovered (MLSR) Government Property Reports must be submitted to proper authorities within the Department of the Navy. The ultimate goal of the MLSR program is to improve the physical security of the Navy program. The Chief of Naval Operations (CNO) is responsible for the policy of MLSR, and the Director, Naval Criminal Investigative Service (NAVCRIMINSERV), is responsible for the management of the program. Commands must report all MLSR incidents and describe the circumstances accurately to ensure the success of the MLSR program.

The anticipated benefit is significant improvement in both ship and shore physical security programs. Reporting of these incidents by MLSR is independent of requesting investigative assistance by NAVCRIMINSERV.

Details of the MLSR program are provided in *Reporting of Missing, Lost, Stolen, or Recovered (MLSR) Government Property*, SECNAVINST 5500.4. Senior Photographer's Mates, imaging-facility managers, and Navy officers should become thoroughly familiar with this instruction.

### **IMAGING EQUIPMENT INCLUDED UNDER THE MLSR PROGRAM**

Because of the nature and expense of imaging equipment and some supplies, most materials used in imaging facilities are included in the MLSR program. The following categories are covered specifically and MLSR reports must be made when items in these categories are missing, lost, stolen, or recovered:

1. Controlled equipage. These items require special attention and control because they are valuable and can easily be converted for personal use. Cameras and lenses are prime examples of controlled equipage.
2. Plant account property, both major and minor.
3. Items that have been stolen or suspected of being stolen with a replacement cost greater than \$100.

An MLSR report should be prepared on DD Form 200, Financial Liability Investigation of Property Loss, for equipment that is missing from your command (fig. 5-18). Materials and equipment that are suspected of being lost, stolen, or damaged beyond economical repair in shipment should be reported on SF-364, Report of Discrepancy, and SF-361, Transportation Discrepancy Report, respectively. Complete details for preparing these reports are provided in SECNAVINST 5500.4.

### **SURVEYS**

A survey is the procedure required for Navy property (except incoming shipments) that is lost, damaged, or destroyed. The purpose of a survey is to determine responsibility and to determine the actual monetary loss to the government. The facts surrounding the loss or damage must be researched thoroughly. This research should not be limited to simply verifying statements of the parties involved. The research must be broad enough to ensure that the

interests of the Navy, as well as the rights of individuals, and Navy activity(ies) concerned are protected. A review is required to prove or refute statements of the persons involved and to place responsibility.

If you are ever involved in a survey report or investigation, refer to *Afloat Supply Procedures*, NAVSUP Publication 485, and *Supply Ashore*, NAVSUP Publication 1, Volume II, for specific information regarding your rights and responsibilities.

### **SURVEY PROCEDURES**

The Financial Liability Investigation of Property Loss, DD Form 200, should be used to document the report of survey and to certify the survey process when government property is lost, damaged, or destroyed. DD Form 200 also serves to adjust the physical inventory on hand with the accountable record.

DD Form 200 should be initiated by the officer responsible (accountable) for the property in question. This officer is required to perform an inquiry and to complete blocks 1 through 11 of DD Form 200. As a minimum, the inquiry should identify the following:

- Who was involved?
- What happened?
- Where did it happen?
- When did it happen?
- How did it happen?
- Is there evidence of negligence, willful misconduct, and deliberate unauthorized use or disposition of the property?

Once the responsible (accountable) officer has completed the inquiry, DD Form 200 must be sent to the appointing authority for review. The review by the appointing authority will include, as a minimum, the following actions:

- Review and evaluate the existing property protection procedures.
- A determination as to whether the procedures prescribed comply with regulations.
- A determination as to whether negligence or abuse is evident.

<b>PRIVACY ACT STATEMENT</b>		(*) MLRSR 1992/001
<b>AUTHORITY</b>	10 USC 136, 10 USC 2775, DOD instruction 7200.10, EO 9397	<b>ROUTINE USES</b> None
<b>PRINCIPAL PURPOSE:</b>	To officially report the facts and circumstances supporting the assessment of financial charges for the loss, damage, or destruction of DOD controlled property. The purpose of soliciting the SSN is for positive identification.	<b>DISCLOSURE:</b> Voluntary, however, refusal to explain the circumstances under which the property was lost, damaged, or destroyed may be considered with other factors in determining if an individual will be held financially liable.
<b>1. DATE INITIATED (YYMMDD)</b> 92 MAR 01		<b>2. INQUIRY/INVESTIGATION NUMBER</b> NOT APPLICABLE
<b>3. DATE LOSS DISCOVERED (YYMMDD)</b> 92 MAR 01		
<b>4. NATIONAL STOCK NO.</b> 7H 5805-01-062-4362	<b>5. ITEM DESCRIPTION</b> POWER SUPPLY S/N 0072	<b>6. QUANTITY</b> 1 EA
<b>7. UNIT COST</b> \$ 10,000.00		<b>8. TOTAL COST</b> \$ 10,000.00
<b>9. CIRCUMSTANCES UNDER WHICH PROPERTY WAS (X one)</b> (Attach additional pages as necessary) Loss discovered during scheduled DLR inventory on 92061 An inventory loss adjustment was posted on 92063 and research was completed on 92065. Receipt documentation and proof of shipments were analyzed with no discrepancies found. A physical check of old location (see attached details)		<input checked="" type="checkbox"/> LOST <input type="checkbox"/> DAMAGED <input type="checkbox"/> DESTROYED
<b>10. ACTIONS TAKEN TO CORRECT CIRCUMSTANCES REPORTED IN BLOCK 9 AND PREVENT FUTURE OCCURRENCES (Attach additional pages as necessary)</b> Cause not specifically identified, but a special review of work center sampling will be conducted within 30 days. (*) NCISRA Naval Station notified 04 MAR 92, declined investigation of inventory loss		
<b>11. INDIVIDUAL COMPLETING BLOCKS 1 THROUGH 10</b>		
<b>a. ORGANIZATIONAL ADDRESS (Unit Designation, Office Symbol, Base, State/Country, Zip Code)</b> R52707 (CG-32) USS WILLIAM H. STANDLEY FPO AP 96678-1155		<b>b. TYPED NAME (Last, First, Middle Initial)</b> Martinez, Richard, SKC, LCPC
		<b>c. AUTOVON/DSN NUMBER</b> 564-3580
		<b>d. SIGNATURE</b>
		<b>e. DATE SIGNED</b> 3/06/92
<b>12. (X one)</b> <input type="checkbox"/> RESPONSIBLE OFFICER (PROPERTY RECORD ITEMS) <input checked="" type="checkbox"/> REVIEWING AUTHORITY (SUPPLY SYSTEM STOCKS)		
<b>a. NEGLIGENCE OR ABUSE EVIDENT / SUSPECTED (X one)</b> <input type="checkbox"/> (1) Yes <input checked="" type="checkbox"/> (2) No		<b>b. COMMENTS / RECOMMENDATIONS</b>
<b>c. ORGANIZATIONAL ADDRESS (Unit Designation, Office Symbol, Base, State/Country, Zip Code)</b> R52707 (CG-32) USS WILLIAM H. STANDLEY FPO AP 96678-1155		<b>d. TYPED NAME (Last, First, Middle Initial)</b> Davis, Larry C. ENS, SC, USN
		<b>e. AUTOVON/DSN NUMBER</b> 564-3581
		<b>f. SIGNATURE</b>
		<b>g. DATE SIGNED</b> 3/06/92
<b>13. APPOINTING AUTHORITY</b>		
<b>a. RECOMMENDATION (X one)</b> <input checked="" type="checkbox"/> (1) Approve <input type="checkbox"/> (2) Disapprove		<b>b. COMMENTS / RATIONALE</b>
		<b>c. FINANCIAL LIABILITY OFFICER APPOINTED (X one)</b> <input type="checkbox"/> (1) Yes <input checked="" type="checkbox"/> (2) No
<b>d. ORGANIZATIONAL ADDRESS (Unit Designation, Office Symbol, Base, State/Country, Zip Code)</b> R52707 (CG-32) USS WILLIAM H. STANDLEY FPO AP 96678-1155		<b>e. TYPED NAME (Last, First, Middle Initial)</b> Landers, Coleman, CDR, SC, USN
		<b>f. AUTOVON/DSN NUMBER</b> 564-3600
		<b>g. SIGNATURE</b>
		<b>h. DATE SIGNED</b> 3/08/92
<b>14. APPROVING AUTHORITY</b>		
<b>a. ACTION (X one)</b> <input checked="" type="checkbox"/> (1) Approve <input type="checkbox"/> (2) Disapprove		<b>b. COMMENTS / RATIONALE</b> (*) CNO (N09N1) NAVSURFWARCENDIV, CRANE (3046)
		<b>c. LEGAL REVIEW COMPLETED IF REQUIRED (X one)</b> <input type="checkbox"/> (1) Yes <input checked="" type="checkbox"/> (2) No
<b>d. ORGANIZATIONAL ADDRESS (Unit Designation, Office Symbol, Base, State/Country, Zip Code)</b> R52707 (CG-32) USS WILLIAM H. STANDLEY FPO AP 96678-1155		<b>e. TYPED NAME (Last, First, Middle Initial)</b> Johnson, Charles B. CAPT., USN
		<b>f. AUTOVON/DSN NUMBER</b> 564-3601
		<b>g. SIGNATURE</b>
		<b>h. DATE SIGNED</b> 3/10/92

DD Form 200, FEB 91

Previous editions are obsolete.

S/N 0102-LF-911-3100

46NVJ098

Figure 5-18A.—DD Form 200 (front).

15. FINANCIAL LIABILITY OFFICER			
a. FINDINGS AND RECOMMENDATIONS <i>(Attach additional pages as necessary)</i>			
(*) Information assigned by activity security office			
b. DOLLAR AMOUNT OF LOSS	c. MONTHLY BASIC PAY	d. RECOMMENDED FINANCIAL LIABILITY	
e. ORGANIZATIONAL ADDRESS <i>(Unit Designation, Office Symbol, Base, State (Country), Zip Code)</i>	f. TYPED NAME <i>(Last, First, Middle Initial)</i>	g. AUTOVON/DSN NUMBER	
	h. DATE REPORT SUBMITTED TO APPOINTING AUTHORITY <i>(YYMMDD)</i>	i. DATE APPOINTED <i>(YYMMDD)</i>	
	j. SIGNATURE	k. DATE SIGNED	
16. INDIVIDUAL CHARGED			
a. I HAVE EXAMINED THE FINDINGS AND RECOMMENDATIONS OF THE FINANCIAL LIABILITY OFFICER AND <i>(X one)</i>			
<input type="checkbox"/> (1) Submit the attached statement of objection.		<input type="checkbox"/> (2) Do not intend to make such a statement.	
b. I HAVE BEEN INFORMED OF MY RIGHT TO LEGAL ADVICE. MY SIGNATURE IS NOT AN ADMISSION OF LIABILITY.			
c. ORGANIZATIONAL ADDRESS <i>(Unit Designation, Office Symbol, Base, State (Country), Zip Code)</i>	d. TYPED NAME <i>(Last, First, Middle Initial)</i>	e. SOCIAL SECURITY NUMBER	
	g. SIGNATURE	h. DATE SIGNED	
f. AUTOVON/DSN NUMBER			
17. ACCOUNTABLE OFFICER			
a. DOCUMENT NUMBER(S) USED TO ADJUST PROPERTY RECORD R52707-2069-8126			
b. ORGANIZATIONAL ADDRESS <i>(Unit Designation, Office Symbol, Base, State (Country), Zip Code)</i> R52707 (CG-32) USS WILLIAM H. STANDLEY FPO AP 96678-1155	c. TYPED NAME <i>(Last, First, Middle Initial)</i> Douglas, Charles B. LCDR, SC, USN	d. AUTOVON/DSN NUMBER 564-4400	
	e. SIGNATURE	f. DATE SIGNED 3/10/92	

DD Form 200 (Back), FEB 91

46NVJ099

Figure 5-18B.—DD Form 200 (back).

- A determination of the cause or probable cause, of the discrepancy.
- Recommended actions to minimize recurrence.

## FURTHER INVESTIGATION

When circumstances warrant, such as an indication of criminal action or gross negligence, the commanding officer may appoint a financial liability officer or a financial liability board to investigate the circumstances of the lost, damaged, or destroyed property. The criteria for appointing a financial liability officer or financial liability board to conduct a formal investigation is as follows:

- It must be recommended by the responsible (accountable) officer.
- It must be directed by higher authority.
- It must be deemed appropriate by the appointing authority.

A criminal investigation must be initiated when research reveals there is evidence of theft. The NAVCRIMINSERV must then be notified to initiate criminal proceedings. The legal officials and the commanding officer of the member must be consulted before any statement is taken from a person suspected of violating the Uniform Code of Military Justice (UCMJ).

When appointed, the financial liability officer is appointed and works with the responsible (accountable) officer to gather and document the facts and circumstances of the gain or loss. The financial liability officer is usually a commissioned officer, warrant officer, or enlisted member in paygrade E8 or E9. An individual who is responsible (accountable) for the items of property in question cannot be appointed as the financial liability officer. Additional research should include, as a minimum, the following actions:

- Review the procedures to protect property for accuracy.
- Determine whether normal procedures were complied with.
- Determine the nature of personal responsibility, if any.

- Recommend corrective action.

Incidents that require further investigation of particular interest to Photographer's Mates are as follows:

- Sensitive items, such as reclaimed silver, regardless of value
- Classified items, regardless of value
- Pilferable items when the extended dollar value of a line item discrepancy is \$750 or more
- Controlled equipment that is missing

Further research should be conducted to do the following:

- Relieve the person responsible (accountable) for the items in question.
- Substantiate adjustment of stock records.
- Identify problem areas.
- Determine corrective action.

The financial liability officer should conduct the review as quickly as possible. If there is a delay of 45 days or more, the financial liability officer must inform the appointing authority, in writing, of the reason(s) for delay.

After completing the investigation, all copies of the report, and attachments thereto, must be returned to the appointing authority or the reviewing authority (normally the commanding officer). The financial liability officer is not relieved from this detail until final action is taken. The appointing authority may agree or disagree with the findings and recommendations presented. When the appointing authority agrees with the report and there is no personal liability noted or recommended, block 13 will be signed and the report forwarded to the approving authority. When the appointing authority does not agree or there is suspicion of personal liability, then separate recommendations are made and the report is forwarded to the approving authority.

The approving authority may approve the findings of the financial liability officer or make recommendations. When the approving authority does

not approve the report, a financial liability board may be appointed.

### **WHEN FURTHER RESEARCH ACTION IS NOT REQUIRED**

Additional research action is not required, beyond preliminary research, into the circumstances of the loss, damage, or destruction of government property by discretion of the commanding officer for the following reasons:

- Negligence is not indicated.
- Negligence or responsibility cannot be determined for reasons that are already known.
- Research is an unnecessary administrative burden.
- There is no death or injury.
- The total property loss, damage, or destruction does not exceed \$200.

- There is no possible claim against the government.

Research action is not usually required when an individual accepts responsibility for the loss, damage, or destruction of government property and offers reimbursement.

The commanding officer may authorize the supply officer to approve surveys of Navy Stock Fund material in the amount of \$10,000 or less. The commanding officer is responsible for all reports of survey and is the approving authority for most Reports of Survey. The commanding officer may approve the final recommendation(s) by inserting "Approved" in block 14 of DD Form 200. Copies of Reports of Survey exceeding \$100,000 must be forwarded to the type commander for final approval. DD Form 200 must be forwarded to higher authority when it lists property for which the commanding officer is personally responsible.

When the commanding officer is not authorized to take final action or for any reason desires to forward the report to higher authority, he or she should make suitable recommendations and forward the report.





## APPENDIX I

# SILVER RECOVERY

Recovering silver from the photographic process saves the government money. These savings can come from two sources: the monetary value of recovered silver and avoiding fines from the Environmental Protection Agency.

Like most natural resources, silver is a valuable and diminishing resource. In photography, silver forms the image on most types of photographic films. Unlike many other natural resources, silver is not destroyed in the photographic process. Much of this silver can be recovered, refined, and used again.

In photography, silver is recovered from two main sources: photographic solutions and black-and-white scraps (film and paper). When most films and papers are processed, some of the silver they contain are removed in the fixing bath. With positive types of black-and-white film, as much as 80 percent of the silver that was in the emulsion may be removed during fixing. With color film and paper, close to 100 percent of the silver is removed in the fixer.

When black-and-white negative film or black-and-white paper with a high percentage of exposed area is processed, most of the silver remains in the emulsion. Most of the silver that remains in film or paper can be recovered.

### ENVIRONMENTAL ISSUES

The awareness and concern for polluting our environment has brought about new legislation and stricter enforcement of existing environmental codes. Silver is one of the heavy metals that is controlled by federal, state, and local legislation. These government agencies monitor the amount of silver that is discharged into the sewer system. Each Navy imaging facility is subject to environmental codes and restrictions of the state and local area. Each state has a similar set of codes that may differ somewhat, so it is important for you to become familiar with them. For example, the maximum silver concentration limit for an imaging facility in Gulfport, Mississippi, may be 5.0 mg/L (ppm), whereas an imaging facility in San Diego, California, may be 0.05 mg/L (ppm).

Compliance with these strictly enforced local sewer code ordinances is of greater concern today than economic gain. Violations can result in severe fines. Individual violators may also be held personally responsible for such fines. An excessive concentration of silver in the effluent of a photographic processor can cause an imaging facility to be closed until the silver concentration is within acceptable limits. A copy of the sewer codes for your local area may be obtained from the sewer authority or from Navy Public Works.

### SILVER RECOVERY TECHNOLOGY

A number of different methods for recovering silver from used photographic solutions are in use today. Two methods that are used commonly in Navy imaging facilities are metallic replacement and electrolytic plating.

#### METALLIC REPLACEMENT

The metallic replacement method uses a plastic cartridge packed tightly with steel wool. The cartridge resembles a 5-gallon bucket with tubes protruding from the cover. The system is inexpensive and well-suited for the small-volume user.

A silver recovery cartridge operates on the principle of metal ion exchange. When the fixer containing silver is passed through the cartridge, the iron in the steel wool or wire screen replaces the silver ions in the fixer. The silver then drops to the bottom of the cartridge as impure metallic silver sludge. The iron ions in the fixer are drained from the cartridge with the fixer into a drain or holding container (fig. AI-1).

In time, the filter material in the cartridge dissolves and the cartridge must be replaced. After about 80 percent of the steel wool is dissolved, the cartridge becomes inefficient and silver passes through the system. The cartridge is actually exhausted before the filter is completely dissolved. A metallic-replacement unit is capable of desilvering to a lower level than an electrolytic plating unit; therefore, some imaging facilities use electrolytic plating unit first and then send the solution through the metallic-replacement cartridge for final treatment.

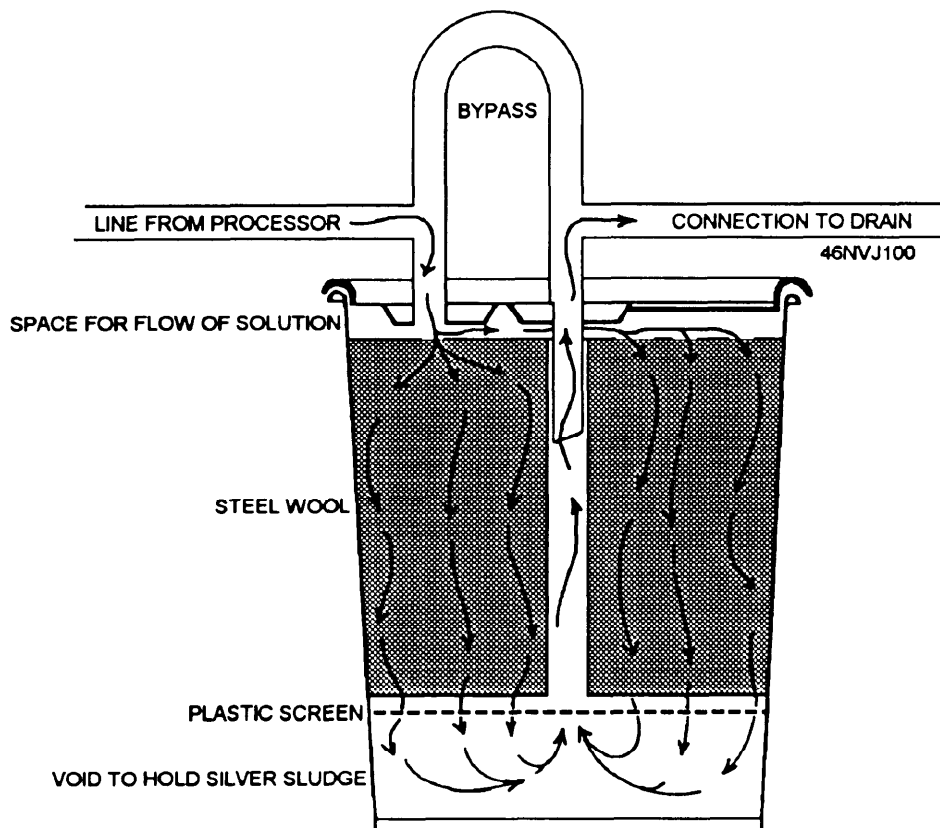

Figure AI-1.—Silver recovery cartridge.

## ELECTROLYTIC PLATING

An electrolytic plating silver recovery unit is more complex than a silver recovery cartridge, but it is actually much easier to operate and control than the processing machines that generate the used solutions. The initial cost is higher than a cartridge; however, the cost is not exorbitant and the electrolytic plating unit should be considered as the primary means for recovering silver from fixers and bleach fixers. Navy imaging facilities are not charged for silver recovery equipment. Procedures for obtaining silver recovery equipment are located in the *Defense Reutilization and Marketing Manual (NOTAL)*, DoD 4160.21-M.

The electrolytic plating method of silver recovery uses two electrodes: a cathode and an anode. They are placed in the silver bearing solution and an electric current is passed between them, causing almost pure silver to plate onto the cathode (fig. AI-2). The silver recovery capacity of the unit is determined by the direct current density and the size of the cathodes; that is, (amperes) in relation to the surface area of the cathode.

Tank size is another measure of recovery capacity. Smaller tanks have less plating capacity because of a proportionately smaller cathode surface area.

### Agitation

An agitation or recirculation system provides a continuous supply of silver-laden solution to the cathode. Without this system, the current density would become too high for the amount of silver present in the solution near the cathode and result in the formation of silver sulfide. This silver sulfide decreases the efficiency of the unit.

### Cathode Design

The cathodes in various electrolytic plating units vary in design. Some units have a simple flat plate; others may have several circular disks mounted on a shaft or use a rotating cylinder (fig. AI-3). Cathodes are made of metal and there are two types: flexible and nonflexible. The flexibility of the cathode makes it easy to remove the silver flake. Those cathodes that are not flexible can be tapped lightly on a flat surface to remove

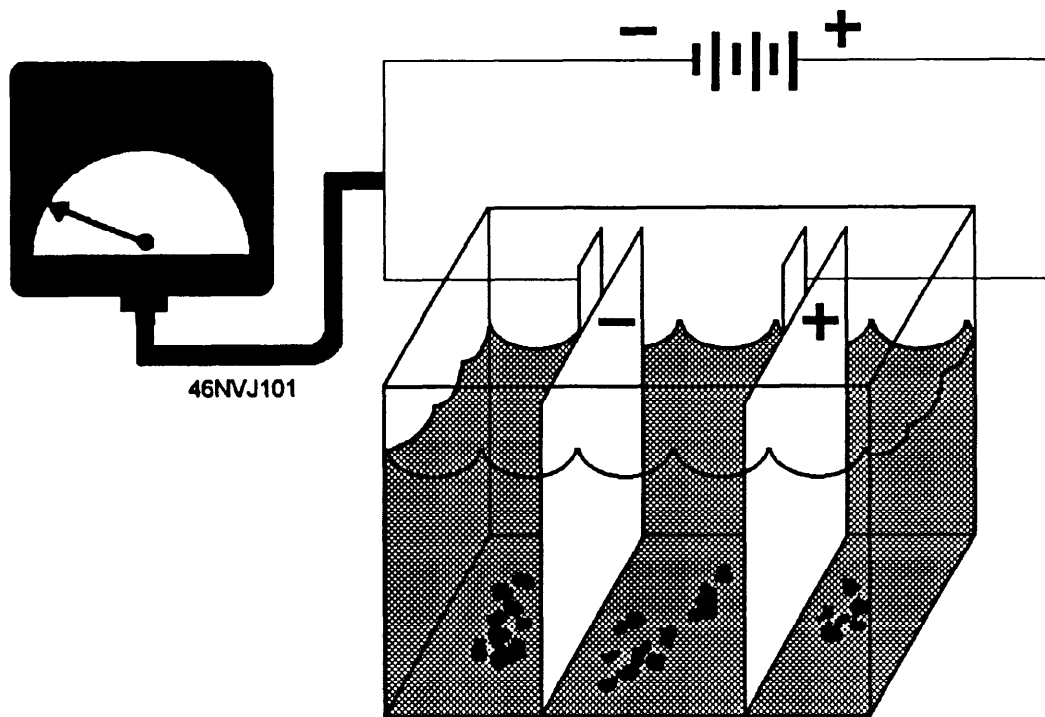

Figure AI-2.—Electrolytic recovery unit.

the silver flake, or the flake can be scraped off with a small putty knife.

### SILVER RECOVERY FROM SCRAP FILM AND PAPER

The silver that remains in black-and-white film and paper after processing can also be recovered when the film and paper become scrap. When an imaging facility has a sufficient amount of black-and-white scrap, the value of the silver in it can be substantial.

Recovering silver from black-and-white film and paper scrap is more difficult than from solutions. This process requires equipment beyond the scope of Navy imaging facilities. Two factors make silver recovery difficult. First, the base must be removed; second, the silver is not in solution. Two basic methods are used to recover silver from scrap film and paper. One method is to burn the scrap, leaving a silver-rich ash. The other method is to remove the silver by a wet-chemical treatment. Both methods require further steps to separate the silver from the ash or the chemical solution.

The need to recover as much silver as possible has caused the Department of Defense (DoD) to set up a precious metals recovery program.

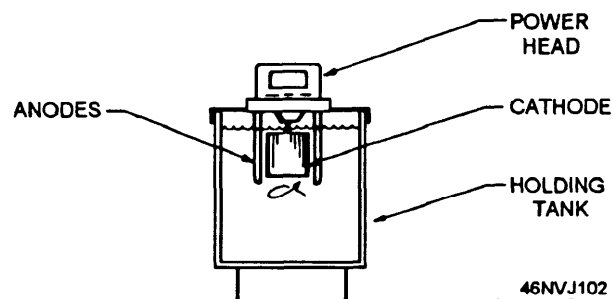

Figure AI-3.—Electrolytic unit with a rotating cathode.

### PRECIOUS METALS RECOVERY PROGRAM

Within DoD there is a continuing requirement for precious metals in the manufacture of defense materials. Because of the diminishing supply of these precious metals from domestic sources and an effort to reduce the procurement cost of equipment containing precious metals, it has become necessary for DoD to establish a Precious Metals Recovery Program (PMRP). As a Photographer's Mate, you should be concerned with the recovery of silver. The requirements of the PMRP are set forth in the *Navy Precious Metals Program*,

NAVSUPINST 4570.23. Participation in the PMRP by all Navy imaging facilities is mandatory.

The Defense Reutilization and Marketing Service, Battle Creek, Michigan, is responsible for programs associated with the collection, recovery, and processing of precious metals. Navy imaging facilities turn in all silver or silver-bearing materials to their local Defense Reutilization and Marketing Office (DRMO). This may include scrap film and paper, used fixer, exhausted silver recovery cartridges, silver sludge, and silver flakes from electrolytic recovery units.

### **OBTAINING SILVER RECOVERY SUPPLIES AND EQUIPMENT**

Requests for PMRP supplies, such as silver test paper, plastic collection containers, silver recovery cartridges, fittings, control valves, and replacement parts peculiar to silver recovery equipment, should be coordinated with your local DRMO. Personnel in DRMO will assist you in obtaining recovery equipment to start up silver recovery operations or to enhance the effectiveness of your current silver recovery operation. Arrangements can then be made for a facility survey to determine the specific requirements for on-site recovery equipment.

### **SECURITY**

The manner in which a Navy imaging facility handles silver-bearing solutions, exhausted recovery cartridges, and silver sludge or flake is subject to security requirements outlined by local authority. As a

minimum, however, the following security measures are suggested:

- Silver that has a high degree of purity should be stored in a safe or locked cabinet within a locked room. Bulky silver-bearing material, such as fixer and scrap film and paper, should be stored in a locked room.

- The weighing and measuring of silver-bearing materials should be accomplished by a designated weigher in the presence of a disinterested person and the initials of both persons should appear on the weight or inventory documentation.

NOTE: The same disinterested individual should not be permitted to sign for more than two consecutive accountings.

- Entry to an area where silver with a high degree of purity is stored temporarily should be restricted to a select group of personnel. Their names should be posted on an access list that is kept current, limited to people with a "need to know," and posted inside the entrance. Visitors with a "need to know" who are granted access be accompanied by an individual on the access list and be required to sign a register. Personnel on the access list do not require a security clearance.

- Persons entering areas where silver or silver-bearing material is stored should be made aware of "condition of entry" by signs located inside the entrance to the storage area.

## APPENDIX II

# BASIC OPERATOR TROUBLESHOOTING

With all the automated processing equipment used in Naval imaging today, it is important for you to have a working knowledge of basic trouble-shooting procedures. By having the ability to analyze a situation and perform some trouble-shooting steps, you are able to isolate problems that occur with imaging equipment. Your ability to locate a faulty condition quickly can play an important part in shortening the equipment downtime. Trouble-shooting procedures are useful for automated processors as well as cameras, enlarging equipment, and so on.

As equipment is used, the parts wear out, even with complete and competent maintenance. As this deterioration occurs, more variation occurs in functioning systems (the evenness of the air from one side of an air squeegee to the other, for example). Additionally, the larger, the more complex, and the older the piece of equipment, the higher the probability that it will malfunction.

### TRUBLE-SHOOTING EQUIPMENT

To function correctly and efficiently, you must care for and maintain equipment properly. Maintenance should be performed consistently and according to established procedures. On complex equipment there are many adjustments that must be performed. Most of these adjustments are not difficult, particularly if you follow detailed 3-M system instructions and instructions supplied by the manufacturer.

### DETECTING MALFUNCTIONS

Troubleshooting a continuous film processor, for example, is an action that evaluates the performance of the processor in terms of both operation and product quality. Each function on a system must operate the way it was designed. If it does not, some signs will become evident. The most common signs are detected as follows:

- **Hearing.** This sense is used to detect malfunctions that produce unusual sounds. Noisy malfunctions may include the improper meshing of gears, worn or improperly lubricated bearings, and

loose or improperly lubricated drive chains. Some types of equipment have alarm systems or buzzers to warn the operator that a problem exists.

- **Sight.** At times, malfunctions are indicated long before they affect product quality. These malfunctions include those displayed on the processor control indicators (temperature, replenishment rates, and speeds) and by indicator lights. Other signs of trouble might include movements, such as a rising lift rod or even the presence of smoke. The first step to take in trouble-shooting circuits after securing power is to inspect the circuit visually. Check for loose connections, loose wires, abraded wires, and loose fittings. An overloaded circuit is a serious problem; at times, the electrical demand on a circuit can cause circuit fuses to blow or circuit breakers to trip. In some cases, incorrect sizes of fuses or circuit breakers were used and the wires overheated and burned off the insulation. This condition can cause shorts and grounds that become potential fire or electrocution hazards. Furthermore, some malfunctions can only be detected by visual examination of the finished product. These malfunctions include scratches, developing streaks, drying streaks, and so on.

- **Touch.** At times, the sense of touch is the best way to detect malfunctions. This is particularly true when total darkness is required to prevent image loss or with moving equipment parts enclosed in some type of housing. Usually, defective bearings or bushings or the need for lubrication of these parts that are concealed in a metal housing can best be detected by feeling for a buildup of heat or unusual vibrations.

- **Smell.** The sense of smell can be used to identify a problem with a piece of equipment. Smoke, hot electrical connections, and so on, may be identified more readily by smell than by sight.

### TRUBLE-SHOOTING TABLES

Troubleshooting a processor or any other type of equipment is not a difficult task. Usually, the manufacturer identifies the most common operating malfunctions, their probable cause(s), and the

procedure(s) required to correct them. These are often produced in table form.

Most trouble-shooting tables are arranged in columns that list the trouble, the probable cause(s), and the remedy(ies) (table AII-1). Once the trouble is identified, you should refer to the table for the probable cause and then make necessary repairs or adjustments to correct the malfunction.

Another type of trouble-shooting table is the logic flow diagram. In a logic flow diagram, you simply "enter" the diagram and follow the arrows to various

blocks or segments and perform the functions indicated or move on to the next segment in a prearranged, logical manner. A logic flow diagram is usually accompanied by other types of diagrams and instructions.

## ELECTRICAL DIAGRAMS

The majority of imaging equipment is operated by electricity. To troubleshoot and perform maintenance on this equipment adequately, you must have a basic knowledge of electricity and be able to read electrical diagrams. You should spend a few moments studying

**Table AII-1.—Trouble-Shooting Table for Electric Ranges**

TROUBLE	PROBABLE CAUSE(S)	REMEDY(IES)
Range does not heat.	No voltage at outlet. Blown fuse. Open breaker. Broken wire in power cord. Faulty wall outlet. Faulty prongs on male plug. Faulty slots in wall outlet.	Correct voltage. Replace fuse. Reset breaker. Check continuity of cord. Check for voltage at outlet. Replace if necessary. Replace if necessary.
No heat at one surface burner.	Loose terminal connections at burner unit. Corroded contacts in control switch. A burned-out element. Open in burner circuit.	Clean and tighten connections. Clean contacts with sandpaper. Replace element. Replace wires if necessary.
Surface burner too hot.	Incorrect or reverse connections.	Switch wires as required.
No heat in oven.	Element connections loose and corroded.	Clean and tighten connections.
Oven too cool.	Burned-out element or elements.	Replace elements.
Oven too hot.	Inoperative oven control.	Adjust or replace control.
Appliances fail to heat when plugged into appliance.	Inoperative oven control.	Adjust and replace control.
Uneven baking.	Range tilted. Oven racks not on proper supports.	Level range. Place racks on proper supports.
Appliances fail to heat when plugged into appliance outlets.	Blown fuse. Loose and corroded circuit connections. Broken circuit wires. Faulty outlet.	Replace fuse. Clean and tighten connections.  Replace wires. Replace if necessary.

the circuit diagrams before you begin troubleshooting; this simplifies the task of isolating the trouble. When a circuit fails to function, you should use the logic diagram approach to locate the fault. The trial-and-error method of locating the fault(s) in a circuit is inefficient and time-consuming. If you have not been trained in electricity, you should read the Navy Electricity and Electronics Training Series (NEETS) Modules, particularly modules 2, 3, and 4. If you already possess knowledge about reading diagrams, the NEETS Modules can help you "get up to speed." Once you understand electrical diagrams, know prescribed maintenance and trouble-shooting procedures, and can use a voltmeter, you should be able to analyze and locate most of the faulty electrical components in imaging equipment.

When working with electricity, Sailors commonly refer to all electrical diagrams as "schematics." This, however, is not correct. A schematic is a specific type of diagram with characteristics of its own and with a specific purpose. Each of the different diagrams has a specific purpose and has distinguishable features that set it apart from the others. These diagrams may be used to do the following:

- learn the operation of a specific system
- locate the components of a system
- identify the components of a system
- trace a circuit
- troubleshoot equipment
- repair equipment

### Pictorial Diagram

The simplest of all diagrams is the pictorial diagram. The pictorial diagram is a picture or sketch of the components of a specific system and the wiring between these components. This simplified diagram identifies components, even if you are not familiar with their appearance. This type of diagram does not show physical locations of components or the manner in which the wiring is marked or routed. It does, however, show you the sequence in which the components are connected (fig. AII-1). After studying the pictorial diagram, you should recognize the components and how they are connected to one another.

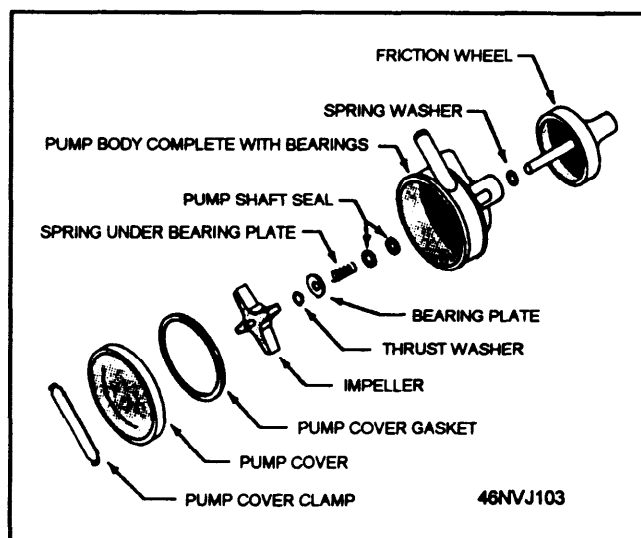

Figure AII-1—Pictorial diagram of a pump assembly.

### Isometric Diagram

The purpose of an isometric diagram is to help you locate a component within a system. This type of diagram shows you the outline of a processor, printer, or other piece of equipment. Within the outline, the various components of a system are drawn in their respective (or relative) locations. The isometric diagram also shows interconnecting cables running between components (fig. AII-2).

### Block Diagram

A block diagram (fig. AII-3) presents a general description of a system and its functions. This type of diagram is often used with accompanying text material. A block diagram shows the major components of a system and the interconnections of these components. All components are shown in block form and each block is labeled for identification purposes.

### Single-Line Diagram

The single-line diagram (fig. AII-4) is used basically for the same purpose as the block diagram. When the single-line diagram is used with text material, it provides you with a basic understanding of the components and their functions in a system.

There are two major differences between the single-line diagram and the block diagram. The first difference is that the single-line diagram uses symbols, rather than labeled blocks, to represent components. Second, the single-line diagram is just that—all components are shown in a single line. There are no

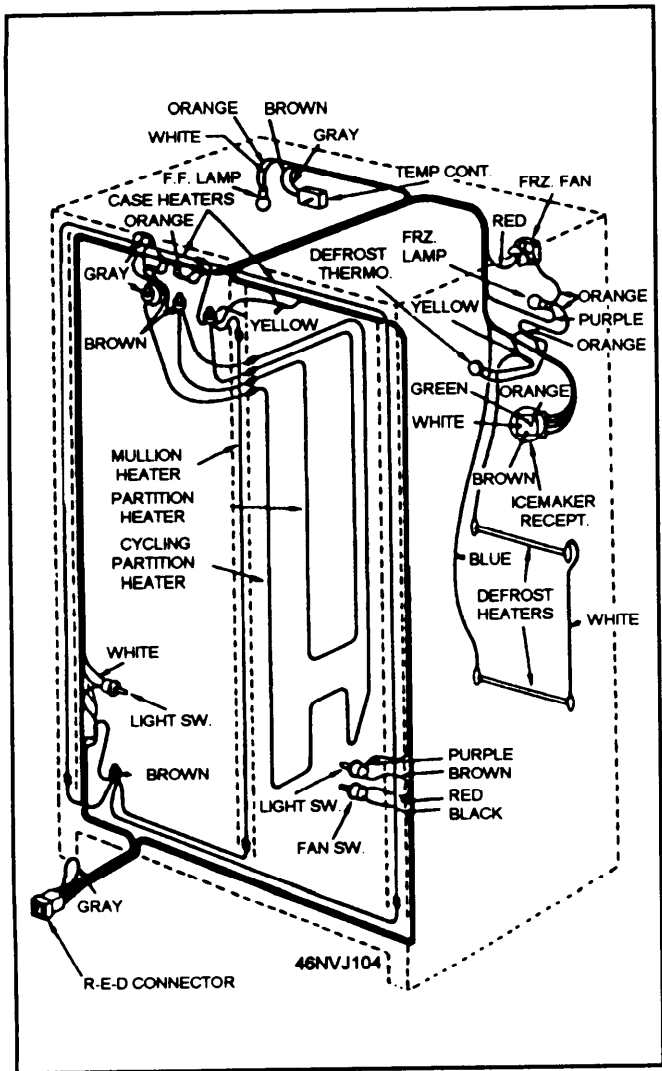

Figure AII-2.—Isometric wiring diagram of a refrigerator.

interconnections for selected components in a single-line diagram, as there are in a block diagram.

The single-line diagram is a simplified type of diagram and should be used primarily to understand, in broad terms, the function of each of the various components in the total system.

### Schematic Diagram

A schematic diagram (fig. AII-5) uses graphic symbols to show both the electrical components and the functional organization of a circuit. You can use the schematic diagram to trace a circuit and its functions without regard to the actual physical size, shape, or location of the component devices or parts. A schematic diagram is most useful for learning the overall operation of a system.

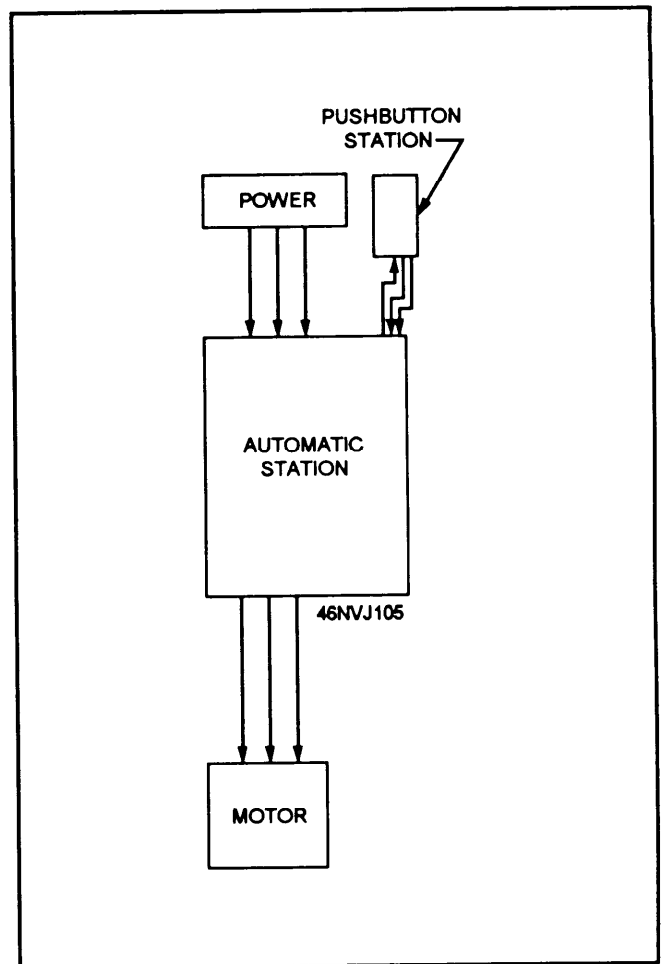

Figure AII-3.—Block diagram.

### Wiring Diagram

A wiring diagram (fig. AII-6) is a detailed diagram of each circuit installation showing all of the wiring, connectors, terminal boards, and electrical or electronic components of the circuit. It also identifies wire by wire number or color code. Wiring diagrams are used to troubleshoot and repair electrical or electronic circuits.

The schematic diagram discussed previously should be used to determine the location where the trouble in the circuit could be when a malfunction occurs. However, the schematic diagram does not show the terminals, connector points, and so on, in the circuit. Therefore, you must use the circuit wiring diagram to determine where to make the voltage or resistance checks in the circuit.

### Terminal Diagram

A terminal diagram is useful when connecting wires to terminal boards, relays, switches, and other



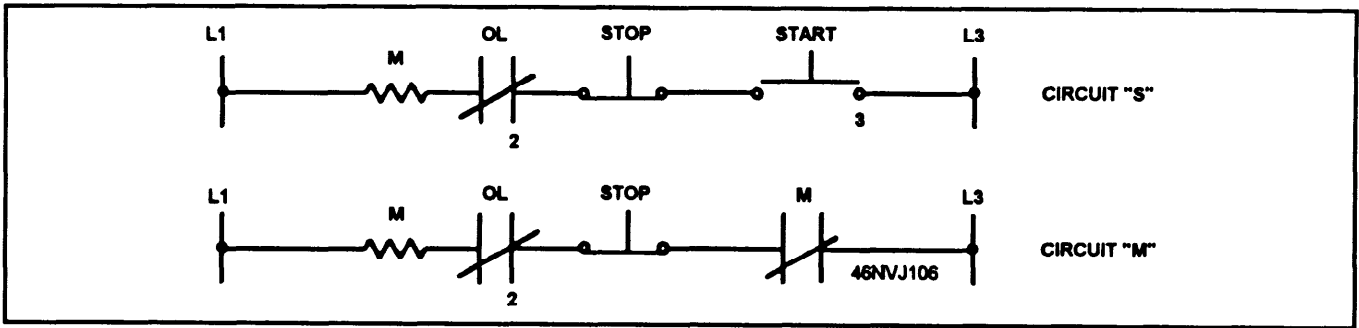

Figure AII-4.—Single-line diagram of a motor control circuit.

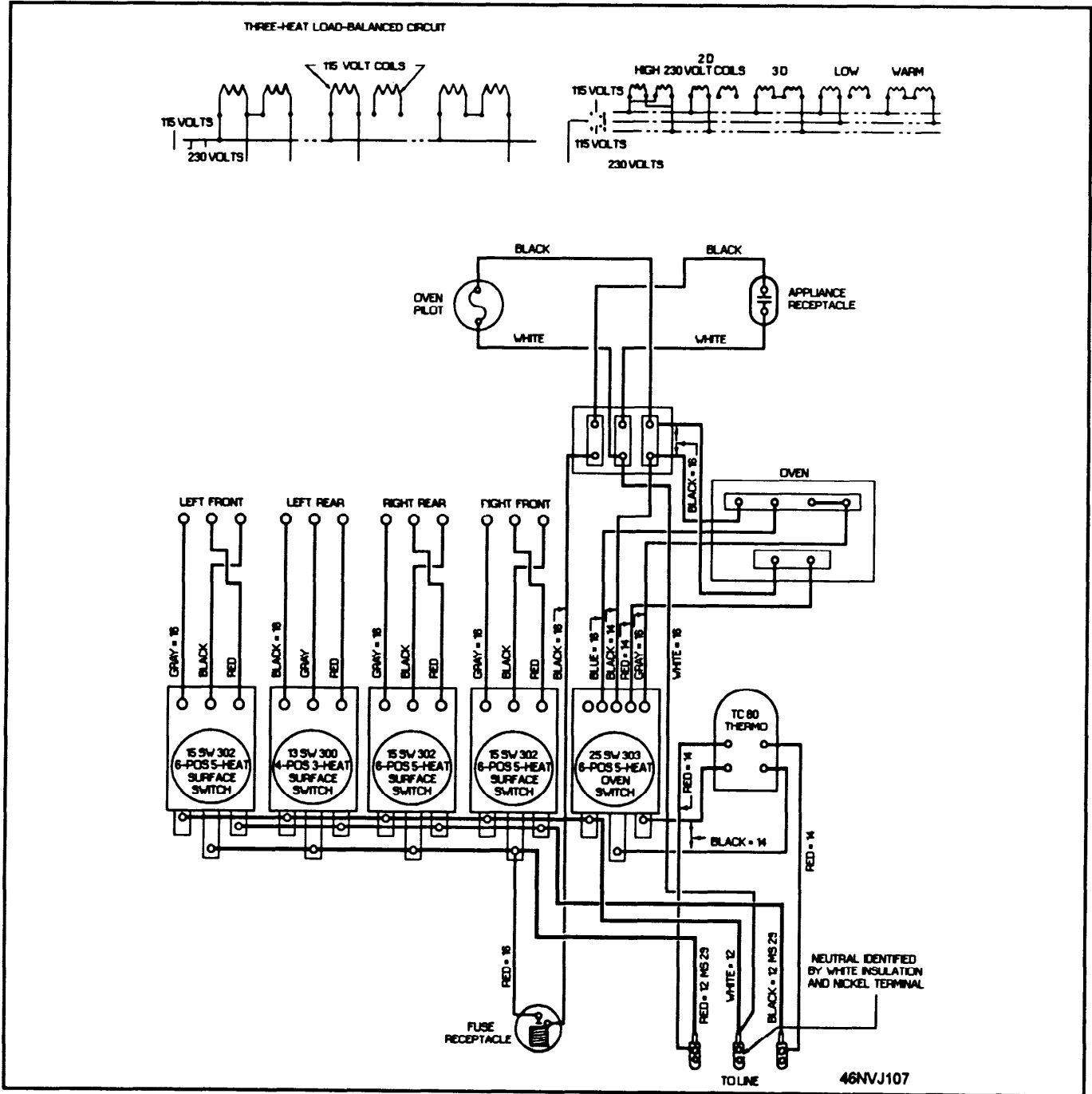

Figure AII-5.—Schematic diagram of an electric range.

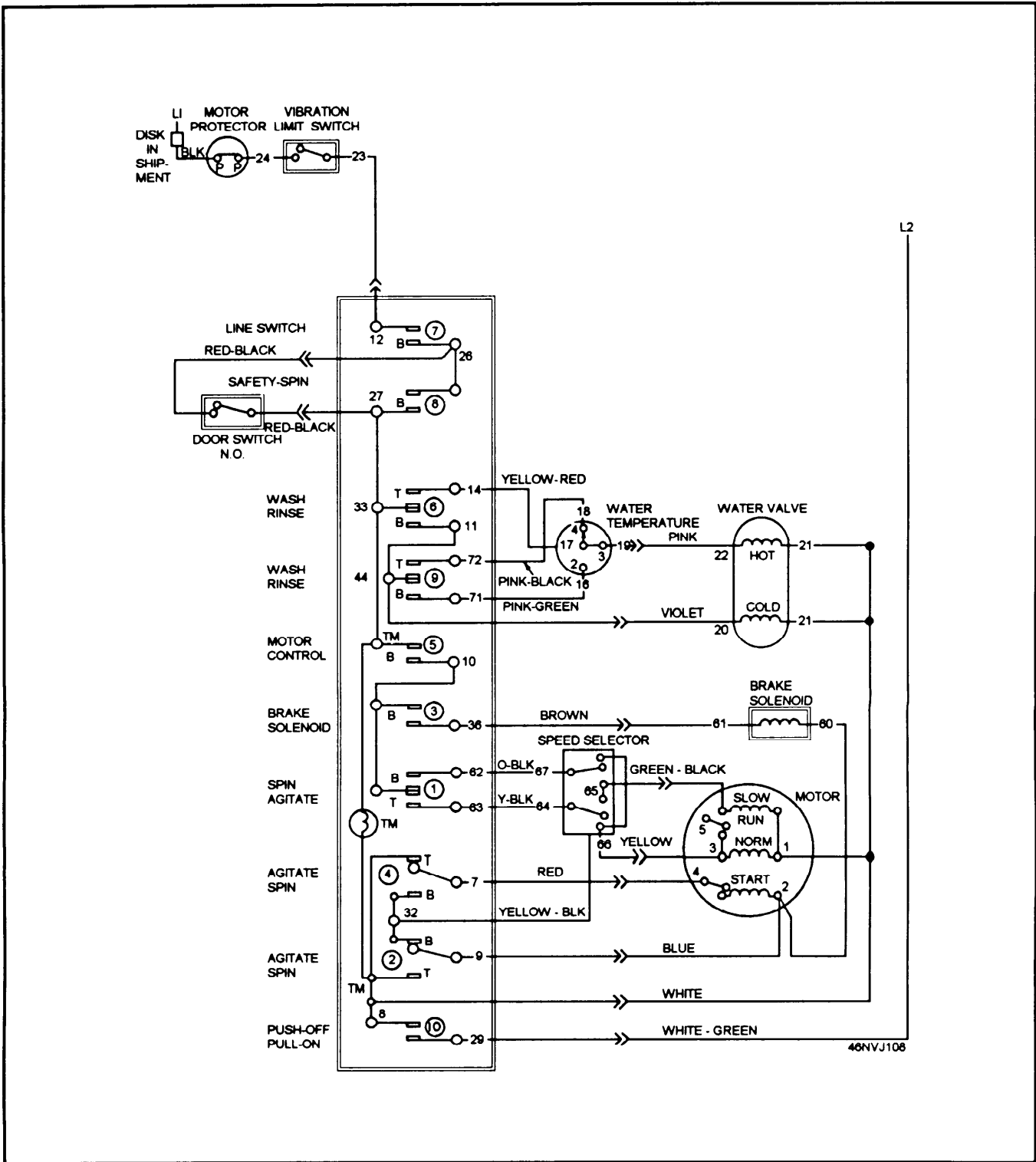

Figure AII-6.—Wiring diagram of a washing machine.

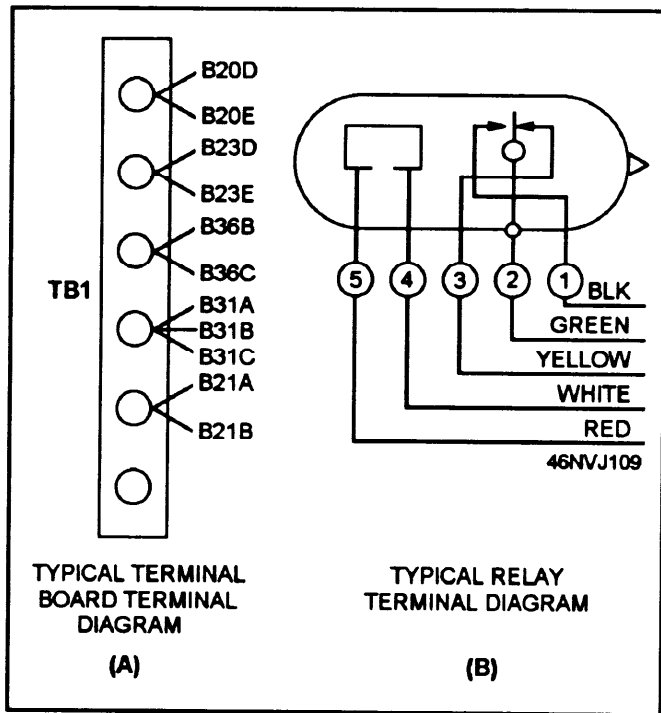

Figure AII-7.—Terminal diagram.

components of a circuit. Figure AII-7 shows two typical terminal diagrams: (A) shows the wire numbers connected to each terminal of a terminal board and (B) shows the color codes of the wires that are connected to a relay.

This has been a brief overview of trouble-shooting procedures and the use and interpretation of the various electrical diagrams. The diagrams discussed were selected because of their simplicity and ease of interpretation. Many diagrams you will encounter are far more complex. Begin with the simpler diagrams. Your proficiency in using the more complex diagrams will increase with experience.



## APPENDIX III

# REFERENCES USED TO DEVELOP THE TRAMAN

<u>Reference</u>	<u>Chapter</u>
Administration of Enlisted Flight Orders, BUPERSINST 1326.4, Bureau of Naval Personnel, Washington, DC, 1993.	4
Afloat Supply Procedures, NAVSUP Publication 485, Revision 2, Navy Department, Naval Supply Systems Command, Arlington, VA, 1993.	5
Cavuoto, James, and Stephen Beale, <i>Guide to Desktop Publishing</i> , Graphic Arts Technical Foundation, Pittsburgh, PA, 1992.	1,3
<i>Data Processing Technician Second Class</i> , NAVEDTRA 12511, Naval Education and Training Program Management Support Activity, Pensacola, FL, 1991.	3
<i>Data Processing Technician Third Class</i> , NAVEDTRA 10263, Naval Education and Training Program Management Support Activity, Pensacola, FL, 1987.	3
DeCock, Liliane, ed., <i>Photo Lab Index Lifetime Edition</i> , 41st ed., Morgan & Morgan, Inc., Dobbs Ferry, NY, 1990.	2
<i>Defense Reutilization and Marketing Manual</i> (NOTAL), DoD 4160.21-M, Department of Defense, Office of the Assistant Secretary of Defense Production & Logistics, Alexandria, VA, 1990.	APP II
<i>Defense Intelligence Agency Manual</i> , DIAM 55-5, Defense Intelligence Agency, Washington, DC, 1990.	4
<i>Journalist 3 &amp; 2</i> , NAVEDTRA 12704, Naval Education and Training Management Support Activity, Pensacola, FL, 1994.	1
Larish, John, <i>Digital Photography: Pictures of Tomorrow</i> , Micro Publishing Press, Torrance, CA, 1992.	3
Larish, John, <i>Photo CD: Quality Photos at Your Fingertips</i> , Micro Publishing Press, Torrance, CA, 1994.	3
Mathematics, Volume 1, NAVEDTRA 10069-D1, Naval Education and Training Program Management Support Activity, Pensacola, FL, 1985.	2
<i>NATOPS General Flight and Operating Instructions</i> , OPNAVINST 3710.7, Office of the Chief of Naval Operations, Washington, DC, 1992.	4
<i>Naval Visual Information Management and Operations Manual</i> , OPNAVINS 5290.1 A, Office of the Chief of Naval Operations, Washington, DC, 1990.	1,4
<i>Navy Precious Metals Program</i> , NAVSUPINST 4570.23, Department of the Navy, Naval Supply Systems Command, Washington, DC, 1991.	APP II
Navy Electricity and Electronics Training Series, Module 4, <i>Introduction to Electrical Conductors, Wiring Techniques, and Schematic Reading</i> , NAVEDTRA B72-04-00-85, Naval Education and Training Program Management Support Activity, Pensacola, FL, 1992.	APP II

**Reference****Chapter**

- Reporting of Missing, Lost, Stolen, or Recovered (MLSR) Government Property, SECNAVINST 5500.4, Department of the Navy, Office of the Secretary, Washington, DC, 1993. 5
- Rosch, Winn L., *The Winn L. Rosch Hardware Bible*, 3d ed., Brady Publishing, Indianapolis, IN, 1994. 3
- Stroebel, Leslie, et al, *Photographic Materials and Processes*, Focal Press, Stoneham, MA, 1986. 2
- Supply Ashore*, NAVSUP Publication 1, Volume II, Navy Department, Naval Supply Systems Command, Washington, DC, 1989. 5
- Todd, Hollis N., and Richard D. Zakia, *Photographic Sensitometry*, Morgan and Morgan, Inc., Dobbs Ferry, NY, 1981. 2
- Using Kodak Ektacolor RA Chemicals*, Kodak Publication No. Z-130, Eastman Kodak Company, Rochester, NY, 1989. 2
- Using Kodak Flexicolor Chemicals*, Kodak Publication No. Z-131, Eastman Kodak Company, Rochester, NY, 1989. 2

# INDEX

- A**
- Aerial film speed (AFS), 4-16
  - Aerial photographic data computer, 4-18
  - Aerial photography, 4-1
    - aerial cameras, 4-9
    - aerial film speed (AFS), 4-16
    - air-to-air photography, 4-5
    - aircraft used for, 4-12
    - camera depression angle, 4-2
    - camera selection, 4-13
    - captioning of, 4-40
    - cartographic photography, 4-6
    - categories of, 4-1
    - communications, 4-27
    - composition, 4-27
    - data computer, 4-18
    - determining exposure, 4-18
    - duplication of aerial images, 4-39
    - exposures required, 4-22
    - film selection, 4-14
    - filters for, 4-14,4-17
    - flight lines, 4-22
    - forward overlap, 4-20
    - IFGA formula, 4-18
    - inspection, preflight and postflight, 4-27
    - interval between exposures, 4-23
    - maritime surveillance, 4-33
    - mission calculations, 4-18
    - mosaic photography, 4-1
    - motion media, 4-34
    - oblique photography, 4-1
    - pinpoint photography, 4-5
    - process evaluation, 4-37
    - Aerial photography—Continued
      - processing of 4-35
      - reconnaissance photography, 4-6
      - safety, 4-26
      - scale, 4-20,4-24
      - shooting hand held, 4-10
      - side lap, 4-20
      - stereo photography, 4-6
      - strip photography, 4-6
      - tilt angle, 4-1
      - types of, 4-5
      - vertical photography, 4-1
      - weather conditions, 4-11
  - Afloat shopping guide, 5-5
- B**
- Bit cell, 3-4
- C**
- Cartographic photography, 4-6
  - Central processing unit (CPU), 3-2
  - Characteristic curve, 2-6
    - emulsion latitude, 2-12
    - exposure latitude, 2-13
    - gamma, 2-13
    - log exposure range, 2-12
    - plotting, 2-8
    - shoulder section, 2-12
    - straight-line section, 2-12
    - toe section, 2-9
  - Charge-coupled device (CCD), 3-8
  - Commodity oriented procurement systems (COPS), 5-7
  - Computer fundamentals, 3-1
    - components of, 3-1
    - general-purpose digital computers, 3-1

Computer fundamentals—Continued

- input/output channels, 3-5
- input unit, 3-2
- memory, 3-1,3-4
- modems, 3-6
- peripheral devices, 3-2
- program, 3-2
- storage, primary and secondary, 3-4

Consolidated Master Cross-Reference List, 5-8

Contrast, 1-23,2-16

- contrast index, 2-17
- contrast index gauge, 2-17
- gamma, 2-13
- high contrast, 1-16
- picture quality, 1-3, 1-5
- summary lead, 1-18

Control charts, 2-23

- alpha risk, 2-26
- beta risk, 2-26
- evaluation of, 2-28
- interpretation, 2-28
- limit lines, 2-26

Custody cards, 5-25

**D**

Densitometry, 2-3

Density, 2-5

Digital signal, 3-6

Digital camera, 3-8

Display prints, 1-8

DoD Consolidated Federal Supply Catalog, 5-5

**E**

Electronic image, 3-7

- editing of, 3-15
- ethics, 3-17
- hardcopy output, 3-13

Electronic image—Continued

- printers, 3-14
- resolution of, 3-17
- Electronic imaging, 3-1,3-7
  - computer configuration, 3-11
  - computer platform, 3-11
  - digital-image file storage, 3-13
  - displays, 3-12
  - five components of, 3-7
  - resolution of, 3-7
  - software, 3-15
  - transmitting, 3-17

Emulsion latitude, 2-12

Ethics pertaining to electronic images, 3-17

Exposure latitude, 2-13

**F**

Family of curves, 2-19

Feature pictures, 1-4

Feature assignments, 1-1, 1-4

- picture quality, 1-3, 1-5
- research, 1-5

Federal Supply Classification System, 5-3

Federal catalog system, 5-3

Fleet and industrial supply centers, 5- 1

Fleet hometown news (FHTN) pictures, 1-16

Floppy disk, 3-3

Forms and publications, 5-17

**G**

Gamma, 2-13,2-16

- basic method, 2-13
- gamma gauge, 2-14
- mathematics computation, 2-13

General Services Administration (GSA), 5-7

GSA catalog, 507



- H**
- Hard drive, 3-3
  - Hardware, 3-1,3-3
- I**
- Illustrated Parts Breakdown (IPB), 5-8
  - Image compression, 3-13
  - Imprest funds, 5-18
  - Integrated circuits (IC), 3-4
  - Inventory, 5-23
    - controlled equipage, 5-26
    - custody cards, 5-25
    - plant property, 5-25
- K**
- Kodak digital camera system (DCS), 3-9
- L**
- Log exposure range, 2-12
    - maximum useful density, 2-12
    - minimum useful density, 2-12
  - Logarithms, 2-3
- M**
- Management List-Navy, 5-4
  - Maritime surveillance photography, 4-33
  - MILSTRIP, 5-12
  - MLSR government property, 5-26
  - Missing planning form, 4-35
  - Modems, 3-6
- N**
- National stock number, 5-3
  - Navy stock list, 5-5
  - Navy stock list of publications and forms, 5-7
  - News writing, 1-17
    - climax, 1-17
    - story ending, 1-19
- News writing—Continued
- story body, 1-19
  - story bridge, 1-19
  - story lead, 1-18
- O**
- Opacity, 2-4
  - Open purchase, 5-17
- P**
- Peripheral devices, 3-4
    - CD-ROM drive, 3-5
    - keyboard, 3-4
    - mouse, 3-5
    - printer, 3-5,3-14
    - scanner, 3-5,3-10
  - pH, 2-22
  - Photographic equipment list, 5-5
  - Photojournalism, 1-1
    - display prints, 1-8
    - feature assignments, 1-1, 1-4
    - feature pictures, 1-4
    - identifying information, 1-4
    - impact, 1-3
    - news writing, 1-17
    - picture essay, 1-13
    - picture layout, 1-19
    - picture seque rice, 1-9
    - picture story, 1-9
    - shooting script, 1-12
    - spot news, 1-1
    - writing text and cutlines, 1-13
  - Picture story, 1-9
    - development of, 1-11
    - shooting script, 1-12
  - Picture layout, 1-19
    - composition, 1-20

Picture layout—Continued  
directional lines of force, 1-20  
primary optical area, 1-19  
scaling, 1-21  
unity, 1-22

Picture sequence, 1-9

Picture essay, 1-13

Pixels, 3-7

Plant property, 5-25

Printers, 3-14

color copiers, 3-14

inkjet, 3-14

thermal-dye transfer, 3-14

thermal-wax transfer, 3-14

## Q

Quality assurance, 2-1

characteristic curve, 2-6

chemical, 2-21

color, 2-30

control charts, 2-23

control strips, 2-6, 2-31

control in processing, 2-17

densitometry, 2-3

monitoring manuals, 2-31

sensitometry, 2-2

## R

Random-access memory (RAM), 3-4

Read-only memory (ROM), 3-4

Reconnaissance photography, 4-6

Report of survey, 5-27

Requisition logbook, 5-23

Requisition forms, 5-11

DD Form 1149,5-11

DD Form 1250-1,5-11

DD Form 1250-2,5-11

Requisition forms—Continued

DD Form 1348,5-11

## S

Scanners, 3-10

SCSI, 3-11

Secondary storage, 3-4

Semiconductor memory, 3-4

Sensitometer, 2-5

Sensitometry, 2-2

sensitometric strip, 2-5

step tablet, 2-6

Servmart, 5-16

Shipboard Uniform Automated Data Processing System (SUADPS), 5-11

Software, 3-2

Adobe Photoshop, 3-15

Aldus PhotoStyler, 3-15

applications, 3-2, 3-7

systems, 3-2, 3-6

utility progrms, 3-7

Specific gravity, 2-22

Speed point, 2-26

Spot news, 1-1

Still-video camera, 3-9

Stock record, 5-19

Stock control, 5-18

high and low limits, 5-21

Stowing materials, 5-18

hazardous materials, 5-18

security, 5-18

Surveys, 5-27

## T

Tactical Air Reconnaissance Pod Systems (TARPS),  
4-1, 4-7

Time temperature charts, 2-19

Time-contrast index curves, 2-19

Time-gamma index curves, 2-19

Transmission, 2-4

Transmitting digital images, 3-17

Trigradient tone reproduction, 4-39

## **U**

Uniform Material Movement and Issue Priority System  
(UMMIPS), 5-15

## **W**

Writing text and cutlines, 1-13



---

---

# *Assignment Questions*

---

---

**Information:** The text pages that you are to study are provided at the beginning of the assignment questions.



# ASSIGNMENT 1

Textbook Assignment: "Basic Photojournalism" and "Photographic Quality Assurance."  
Pages 1-1 through 2-5.

---

- Learning Objective: Identify the purpose of photojournalism.
- 1-1. Which of the following attributes is the most important requirement of a Navy photojournalist?
1. The ability to write good stories
  2. The recognition for winning several photo contests
  3. The skillful use of camera equipment
  4. The application of state-of-the-art equipment
- 1-2. The assignments of Navy photojournalists involve only those subjects with great human interest value.
1. True
  2. False
- 1-3. The assignments of a Navy photojournalist can be categorized into what two groups?
1. Spot news and feature pictures
  2. News writing and photography
  3. Photo layout and typesetting
  4. Desktop publishing and prepress cropping
- Learning Objective: Identify purposes of spot-news photographs.
- 1-4. Spot-news photographs involve current events while a feature assignment emphasizes human interest.
1. True
  2. False
- 1-5. Which of the following factors is the most important for getting a spot-news photograph published?
1. Using interesting camera angles
  2. Using dramatic lighting techniques
  3. Providing black-and-white glossy prints
  4. Providing an image that is newsworthy
- 1-6. Of the following elements, which one provides the stopping power for a photograph?
1. Newsworthiness
  2. Human interest
  3. Impact
  4. Photographic quality
- 1-7. Which of the following techniques helps to create impact in a news photograph?
1. Using dramatic lighting
  2. Recording peak action
  3. Separating the subject from the background
  4. Each of the above
- 1-8. It is important that photographs used for news purposes be free of all imperfections.
1. True
  2. False
- 1-9. You are printing a photograph for reproduction in a newspaper or magazine. You should make the print so it has what contrast?
1. High
  2. Low
  3. Normal
  4. It does not matter since the print will be reproduced as a half-tone image.
- 1-10. When possible, a photographic print that will be reproduced in a newspaper or magazine should be printed on what paper surface?
1. Glossy
  2. Matte
  3. Luster
  4. Pearl
- 1-11. In a newspaper, the width of a column is approximately what number of inches?
1. 1
  2. 2
  3. 3
  4. 4

---

Learning Objective: Recognize the purposes of feature pictures.

---

- 1-12. The first stage of a feature assignment should involve what process?
1. Preparing a shooting script
  2. Cleaning the camera equipment
  3. Arranging transportation
  4. Conducting research
- 1-13. A feature picture serves which of the following purposes?
1. To inform
  2. To entertain
  3. To provoke a response
  4. Each of the above
- 1-14. Which of the following statements pertaining to a feature picture is NOT true?
1. It should provide a clear message
  2. It is critical for photographs to be published as quickly as possible
  3. You can create a mood using various lighting techniques
  4. you can control the composition of the subject
- 1-15. Which of the following practices helps to increase the impact of a feature picture?
1. Use various focal-length lenses
  2. Use a normal lens only
  3. Use a telephoto lens only
  4. Use a wide-angle lens only
- 1-16. Which of the following camera angles is least likely to create the desired impact of your subject?
1. Low
  2. Eye level
  3. High

- 1-17. You are making a print for display in the quarterdeck area of your command. The photograph should be printed in what manner?
1. It should appear to have normal contrast and density when viewed under a viewing booth
  2. It should appear to have normal contrast, but slightly lighter than normal
  3. It should appear to have normal density, but the contrast should be slightly higher than normal
  4. It should appear to have normal contrast and density when viewed from the location in which it is displayed

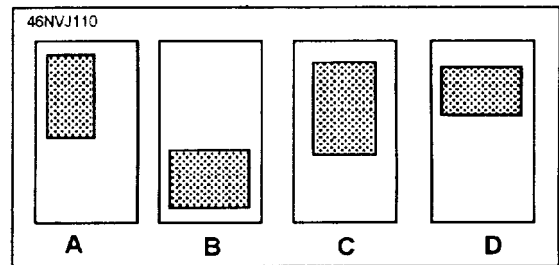

Figure 1A

IN ANSWERING QUESTION 1-18, REFER TO FIGURE 1A.

- 1-18. What print is positioned in the optical center of the mount?
1. A
  2. B
  3. c
  4. D

---

Learning Objective: Identify procedures used to complete feature assignments.

---

- 1-19. A picture sequence is a series of photographs that centers around what number of subjects?
1. One
  2. Two
  3. Three
- 1-20. Which of the following methods of producing a picture sequence is the most dramatic?
1. Fixed camera and subject
  2. Fixed camera, subject moves
  3. Subject fixed, camera moves
  4. Camera and subject move



- 1-21. A group of loosely related photographs that provides the reader with only a few miscellaneous impressions of an event is known as a picture
1. story
  2. essay
  3. sequence
  4. feature
- 1-22. In an illustrated-text picture story, what is the primary tool of communication?
1. Words only
  2. Photographs only
  3. Words or photographs
- 1-23. In a picture-text combination, what is the primary tool of communication?
1. Words only
  2. Photographs only
  3. Words and photographs
- 1-24. What term is used to describe an arrangement of facts that you have collected during the development of your picture story?
1. Sorting
  2. Sequencing
  3. Treatment
  4. Compiling
- 1-25. Of the following Navy picture-story topics, which one would probably be the most interesting to a large audience?
1. Ships
  2. Aircraft
  3. Weapons
  4. Women
- 1-26. Once a shooting script is developed, you should never deviate from it?
1. True
  2. False
- 1-27. What picture is most important in a picture story?
1. Lead
  2. Body
  3. Ending
- 1-28. In a picture story, a lead photograph serves what purpose(s)?
1. To create impact
  2. To identify the subject matter
  3. To instill desire within the viewer to know more about the subject
  4. Each of the above
- 1-29. In a picture story, what is the second most important photograph?
1. Lead
  2. Body
  3. Ending
- 1-30. What is the primary purpose of the ending photograph in a picture story?
1. To cause the viewers to desire follow-up information on the subject
  2. To provide the viewers with a conclusion
  3. To encourage the viewers to change their opinion of the subject
  4. To fill dead space in the lower right-hand corner of the layout
- 1-31. In a picture story, which, if any, of the following statements describe the purpose of cutlines?
1. To reinforce the text
  2. To answer the five "Ws"
  3. To bridge the gap between the text and the photographs
  4. None of the above
- 1-32. Which of the following statements pertaining to a picture essay is true?
1. It may be subjective
  2. It must have continuity
  3. It should be based on facts
  4. It must follow a logical order
- 1-33. Which of the following feature assignments permits the photographer to present his own personal point of view?
1. Picture story
  2. Picture sequence
  3. Feature picture
  4. Picture essay
- 1-34. Which of the following photographic assignments is NOT entirely objective?
1. Picture story
  2. Picture essay
  3. Picture sequence
  4. Feature picture

- 1-35. Which of the following statements pertaining to a picture essay is NOT true?
1. It is organized around a central theme
  2. It is subjective
  3. It has a definite plot
  4. It does not have a well-defined beginning, middle, or ending

---

Learning Objective: Recognize guidelines for submitting fleet hometown news (FHTN) photographs.

---

- 1-36. What is the primary purpose of FHTN releases?
1. To provide Sailors in the fleet with information about their hometowns
  2. To provide the hometowns of military members with brief stories about military people
  3. To provide military members with base closure listings in their hometown area
  4. To provide hometowns across the nation with information on new weapon systems used by the fleet
- 1-37. Which of the following photographs should NOT be submitted with an FHTN story?
1. A formal portrait
  2. An informal portrait
  3. A portrait showing the subject in an embarrassing situation
  4. A portrait showing the subject at work
- 1-38. A photograph intended for FHTN release should normally be presented in what format?
1. Vertical only
  2. Horizontal only
  3. Either vertical or horizontal
- 1-39. You should refer to what instruction for guidance concerning FHTN releases?
1. OPNAVINST 4790.4
  2. OPNAVINST 5250.1
  3. SECNAVINST 5500.4
  4. SECNAVINST 5724.3

---

Learning Objective: Identify writing guidelines for a photojournalist.

---

- 1-40. When writing a news story, what should be your main objective?
1. To impress readers with your literary style
  2. To impress upon the readers the importance of the subject
  3. To provide readers with accurate, understandable information
  4. To ensure the written text supports the photographs
- 1-41. In a news story, the climax is presented in what location?
1. At the beginning
  2. In the body
  3. At the end
- 1-42. In news writing, a sentence must not exceed what number of words?
1. 8
  2. 12
  3. 18
  4. 30
- 1-43. When news writing, you should strive to write paragraphs in what manner?
1. So they contain as much information about the story as possible
  2. So they contain no more than three sentences
  3. So they express one complete thought
  4. So they have a minimum of 60 words
- 1-44. In news writing, what component of a written article contains the most important facts?
1. Lead
  2. Bridge
  3. Body
  4. Ending
- 1-45. What type of lead is used most commonly for news articles?
1. Novelty
  2. Summary
  3. Preface
  4. Injunction
- 1-46. What novelty lead is the most unconventional?
1. Contrast
  2. Shock
  3. Direct address
  4. Freak

- 1-47. In news writing, what is the purpose of a story bridge?
1. To provide most of the important facts
  2. To smooth the transition between the lead and the body
  3. To draw reader attention
  4. To support the photographs used in the story

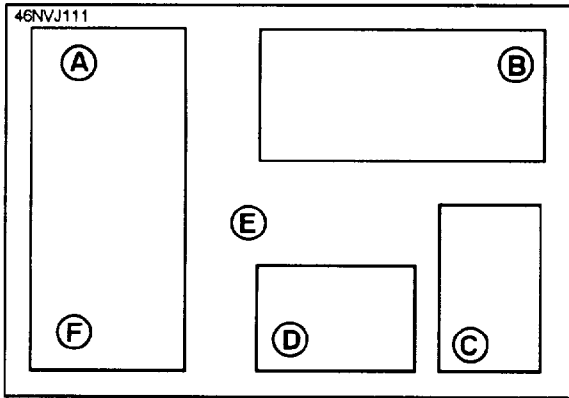

Figure 1B

IN ANSWERING QUESTION 1-48 AND 1-49, REFER TO FIGURE 1B.

- 1-48. The primary optical area is located in what area?
1. A
  2. B
  3. E
  4. F
- 1-49. The eyes of a reader are least attracted to what areas of the layout?
1. A and B
  2. A and C
  3. B and F
  4. C and D
- 1-50. On a layout, the dominant photograph should be the largest. Other photographs in the layout should not exceed what percentage of the dominate photograph?
1. 25%
  2. 50%
  3. 75%
  4. 100%

---

Learning Objective: Identify the purpose of photographic quality assurance (QA).

---

- 1-51. Once established, photographic quality standards must be inflexible.
1. True
  2. False
- 1-52. What is the ultimate goal of quality assurance in photography?
1. To reduce the time required to produce photographic products
  2. To test photographic sensitized materials
  3. To ensure maximum use of personnel and materials
  4. To ensure the final photographic product is of high quality
- 1-53. The quality of a photographic product depends upon what three factors?
1. Human, material, and mechanical
  2. Chemical, human, and mechanical
  3. Chemical, time, and personnel
  4. Equipment, personnel, and time
- 1-54. What category of personnel makes up the human element in a photographic QA program?
1. The photographer
  2. The processing machine operator
  3. The quality assurance technician
  4. Each of the above
- 1-55. Your QA program consists solely of comparing prints to one another visually. What type of QA program are you operating?
1. Subjective
  2. Objective
  3. Reference standard
  4. Sensitometric
- 1-56. What factor(s) of film contribute(s) the most toward high-quality photographs?
1. Storage
  2. Handling
  3. Exposure only
  4. Exposure and processing

- 1-57. To ensure the workers in your imaging facility are following the instructions of the manufacturer when they process film, you should take what action?
1. Monitor the process continually
  2. Supervise personnel constantly
  3. Inspect each photograph produced personally

---

Learning Objective: Recognize the theory behind sensitometry.

---

- 1-58. A good quality assurance program is built on what type of foundation?
1. Subjectivity
  2. Camera exposures
  3. Sensitometry
  4. Visual comparisons

- 1-59. In what way does sensitometry provide information about processing problems?
1. Scientific opinion
  2. Personal judgment
  3. Numbers
  4. Subjective analysis

- 1-60. The photographic characteristics of light-sensitive materials are determined by what science?
1. Sensitometry
  2. Densitometry
  3. Chemical analysis
  4. Logarithmic interpretation

- 1-61. You should use logarithms in which of the following situations?
1. When densitometers are used in producing transparencies
  2. When plotting characteristic curves
  3. When determining density, gamma, and log H
  4. Each of the above

---

Learning Objective: Demonstrate basic understanding of logarithms and their uses.

---

- 1-62. What is the common logarithm of 100,000?
1. 1
  2. 5
  3. 3
  4. 6

- 1-63. What is the common logarithm of 0.00001?
1. 1
  2. -5
  3. -1
  4. 5

- 1-64. What is the common logarithm of 2?
1. 0.10
  2. 0.20
  3. 0.30
  4. 0.40

- 1-65. What is the antilog of 0.78?
1. 87.0
  2. 2.0
  3. 6.0
  4. -2.0

- 1-66. Logarithms are used to plot exposure on characteristic curves for which of the following reasons?
1. To reduce the numbers that indicate exposure to a manageable form
  2. So both density and exposure are on the same scale
  3. Both 1 and 2 above

---

Learning Objective: Identify transmission and light-stopping properties of photographic emulsions.

---

- 1-67. You are measuring the density of a negative with a light source of 100 meter-candles. The negative transmits 1.0 meter-candle. What is the transmission of the negative?

1. 1/5
2. 1/10
3. 1/25
4. 1/100

- 1-68. What is the opacity of a negative that transmits 1/5 of the light that falls on it?

1. 5
2. 2
3. 7
4. 10

1-69. When 26 mc of light are falling onto a film, but only 7 mc of light are passed by the film, what percentage of the incident light is being transmitted?

1. 19%
2. 27%
3. 37%
4. 41%

1-70. What is the opacity of a negative that transmits 1 percent of the light that falls on it?

1. 100
2. 90
3. 40
4. 30

1-71. Density, the light-stopping ability of a photographic emulsion, is expressed by which of the following statements?

1. Logarithm of transmission
2. Logarithm of opacity
3. Reciprocal of opacity
4. Reciprocal of transmission

1-72. In sensitometry, you should be most concerned with what factor?

1. Incident light
2. Transmission
3. Opacity
4. Density

# ASSIGNMENT 2

Textbook Assignment: "Photographic Quality Assurance." Pages 2-5 through 2-29.

---

Learning Objective: Identify the principles of sensitometry.

- 2-1. For which, if any, of the following reasons are sensitometers used to expose light-sensitive materials in a QA program?
1. They are easier to operate in complete darkness than a 35mm camera
  2. They provide a known quantity and quality of light
  3. They provide exact density readings
  4. None of the above
- 2-2. In studying the characteristics of a light-sensitive material, you should use what instrument to make a series of graded exposures on the material being tested?
1. Densitometer
  2. Sensitometer
  3. Exposure meter
  4. Wedge spectrograph
- 2-3. To determine the response characteristics of an emulsion under conditions that simulate actual photography, the light source of your sensitometer must meet which of the following conditions?
1. The color temperature of the light must be equivalent to that of the light used in practical photography
  2. The time of exposure must be accurately controlled
  3. The intensity of light must be known
  4. All of the above
- 2-4. What is the approximate color temperature of an incandescent light source in a sensitometer?
1. 2400 K
  2. 3200 K
  3. 5400 K
  4. 7000 K
- 2-5. What is the approximate color temperature of sunlight?
1. 2400 K
  2. 3200 K
  3. 5400 K
  4. 7000 K
- 2-6. What is the purpose of the step tablet in a sensitometer?
1. It is used to produce a logarithmically graded series of exposures
  2. It allows you to stack strips of film without damaging them
  3. It controls the amount of voltage supplied to the light source
  4. It lists the procedural steps for producing a sensitometric strip
- 2-7. What is the density difference between each step on an 11-step step tablet?
1. 1.00
  2. 0.11
  3. 0.15
  4. 0.30
- 2-8. On a 21-step step tablet, there is a difference of what number of f/stops between each step?
1. 1
  2. 2
  3. 1/2
  4. 1/3
- 2-9. You are preparing to process a control strip through a roller-transport processor. You should feed the control strip into the processor in what manner?
1. Low-density end first
  2. High-density end first
  3. It does not matter which end is fed first

- 2-10. You are using a sensitometer with a light source that supplies an exposure of 501 lux/seconds and a 21-step step tablet. The film step with the highest density receives what amount of exposure?
1. 4.80 log/lux seconds
  2. 2.70 log/lux seconds
  3. 2.65 log/lux seconds
  4. 2.10 log/lux seconds

---

Learning Objective: Recognize steps used to plot characteristic curves.

---

- 2-11. What does the vertical axis represent on a characteristic curve?

1. Exposure
2. Gamma
3. Density
4. Contrast

- 2-12. What does the horizontal axis represent on a characteristic curve?

1. Exposure
2. Gamma
3. Density
4. Contrast

- 2-13. On a characteristic curve, an increase of exposure is indicated in what relationship?

1. From left to right
2. From right to left
3. From top to bottom
4. From bottom to top

- 2-14. What instrument is used to read the steps on a sensitometric strip?

1. Sensitometer
2. Wedge spectrograph
3. Exposure meter
4. Densitometer

- 2-15. At what location on a characteristic curve is step 1 of a sensi-strip plotted?

1. The lower right-hand corner
2. The lower left-hand corner
3. The upper right-hand corner
4. The upper left-hand corner

- 2-16. A characteristic curve that is drawn properly should have what appearance?

1. Straight lines connected to each plotted point
2. Very apparent angles
3. A single, smooth-flowing line
4. All points connected by curved lines

- 2-17. What type of information should you include on the graph of a characteristic curve?

1. The film type only
2. The developer type only
3. The processing temperature only
4. All of the above

---

Learning Objective: Identify information that can be derived from a characteristic curve.

---

- 2-18. Which of the following factors may be derived from an analysis of a characteristic curve?

1. Contrast
2. Effective speed
3. Useful exposure range
4. All of the above

- IN ANSWERING QUESTIONS 2-19 THROUGH 2-22, REFER TO THE FOLDOUT, FIGURE 2-6, AT THE BACK OF CHAPTER 2.

- 2-19. What is the lowest density recorded on the graph?

1. 1.00
2. 0.16
3. 0.10
4. 0.05

- 2-20. What is the highest density recorded on the graph?

1. 1.84
2. 2.10
3. 3.00
4. 4.50

- 2-21. What is the density at step 11?

1. 1.50
2. 1.19
3. 0.66
4. 0.40

- 2-22. What step(s) on the graph indicate(s) gross fog?
1. 1 only
  2. 1 and 2 only
  3. 3 and 4 only
  4. 1, 2, 3, and 4
- 2-23. What section of a characteristic curve represents the shadow areas of a subject?
1. Toe
  2. Straight line
  3. Shoulder
  4. Slope
- 2-24. What point on a characteristic curve indicates the least amount of exposure and produces a noticeable change in density?
1. The speed point
  2. The inertia point
  3. The threshold
  4. The minimum useful density
- 2-25. What section has the greatest slope or gradient on a characteristic curve?
1. Toe
  2. Straight line
  3. Shoulder
  4. Threshold
- 2-26. On a characteristic curve, what section indicates an equal change in density for an equal increase in exposure?
1. Toe
  2. Straight line
  3. Shoulder
  4. Threshold
- 2-27. The bright, highlight tones of a subject are indicated on what portion of a characteristic curve?
1. Toe
  2. Straight line
  3. Shoulder
  4. Threshold
- 2-28. At what section of a characteristic curve does the density decrease when there is an increase in exposure?
1. Toe
  2. Straight line
  3. Shoulder
  4. Threshold
- 2-29. The range of exposures covered by the straight-line section of a characteristic curve is known by what term?
1. Emulsion latitude
  2. Exposure latitude
  3. Useful exposure range
  4. Total exposure scale
- 2-30. As the contrast of a film increases, the emulsion latitude
1. increases
  2. decreases
  3. remains the same
- 2-31. You are determining the useful exposure range of a ground-pictorial film. What sections of a characteristic curve should you consider when making this determination?
1. Toe section only
  2. Straight-line section only
  3. Shoulder section only
  4. Toe, straight-line, and shoulder section
- 2-32. For ground-pictorial film, the minimum useful density is at what point on a characteristic curve?
1. Gross fog
  2. 0.10 above gross fog
  3. 0.30 above gross fog
  4. 90 percent of the maximum density
- 2-33. What term describes the margin of exposure error?
1. Exposure latitude
  2. Speed point
  3. Gamma infinity
  4. Exposure range
- 2-34. Which of the following film and subject combinations provide the greatest exposure latitude?
1. Kodalith Ortho and a block diagram
  2. Kodachrome 25 and a landscape scene
  3. Kodacolor Gold 400 and a foggy seascape
  - 4.
- 2-35. A film with which of the following ISO speeds has the greatest exposure latitude?
1. 50
  2. 100
  3. 200
  4. 400



---

Learning Objective: Demonstrate understanding of gamma and the way it is calculated.

---

---

Learning Objective: Identify factors that affect the contrast of light-sensitive materials.

---

2-36. The slope or gradient of the straight-line portion of a characteristic curve is determined by the relationship between a given log H interval and which of the following factors?

1. Useful exposure scale
2. Emulsion latitude
3. Total density range
4. Corresponding density difference

2-37. What range of gamma is desirable for negatives used to record ground-pictorial subjects?

1. 1.00 to 1.50
2. 1.20 to 2.40
3. 0.65 to 0.90
4. 0.60 to 2.40

2-38. What gamma provides an equal change of densities for an equal change of exposures in the straight-line section of a characteristic curve?

1. 1.00
2. 2.00
3. 0.30
4. 0.50

2-39. Which of the following symbols is used to indicate change or difference?

1. Alpha
2. Beta
3. Delta
4. Gamma

2-40. Determine the gamma of a negative using the following information.  $H_1 - H_2$  is equal to 2.00 and  $D_1 - D_2$  is equal to 1.00.

1. 1.00
2. 2.00
3. 3.00
4. 0.50

2-41. You are determining the gamma of a characteristic curve.  $\Delta D$  is 0.65 and  $\Delta H$  is 0.95. What is the gamma?

1. 1.00
2. 1.46
3. 0.68
4. 0.39

2-42. A negative may contain which of the following types of contrast?

1. Midtone
2. Highlight
3. Shadow
4. Each of the above

2-43. Other than personal preference, you should use what factor to determine the contrast-printing filter with which a black-and-white negative will print best?

1. Gamma
2. Contrast index
3. Total negative contrast
4. Emulsion latitude

2-44. You have processed several rolls of the same type of black-and-white negative film to the same gamma. After inspecting the negatives, you determine that all the negatives were exposed correctly. Therefore, you can assume that all of the negatives can be printed using the same contrast-printing filter.

1. True
2. False

2-45. Gamma can be considered as the ratio between what factors?

1. Scene brightness range and negative density
2. Scene contrast and negative contrast
3. Scene contrast and negative density
4. The shoulder and the toe of a characteristic curve

2-46. When film exposures extend into the toe section of the D-log H curve, what measurement should you use to measure the effects of exposure and development?

1. Contrast index
2. Gamma
3. pH
4. Specific gravity

- 2-47. You are taking aerial photographs of a ship that is under suspicion of transporting weapons illegally. What section of a characteristic curve should place the shadow areas of this subject?
1. Toe
  2. Straight line
  3. Shoulder
- 2-48. Which of the following contrast measurements does NOT take shadow and highlight densities into account?
1. Gamma
  2. Contrast index
  3. Total density range
  4. Each of the above
- 2-49. Which of the following statements regarding gamma and contrast-index values of photographic materials is incorrect?
1. They are fixed values
  2. They are not fixed values
  3. The values fluctuate according to the developer being used
  4. The values change according to the method of processing being used
- 2-50. With all other factors constant, a change in which of the following areas influences gamma or contrast index the greatest?
1. Exposure
  2. Latitude
  3. Light intensity
  4. Development
- 2-51. Which of the following terms describes the point when gamma reaches its maximum level?
1. Gamma infinity
  2. Gamma burnout
  3. Gamma climax
  4. Gamma reciprocation
- 2-52. Ground-pictorial film should be processed to which of the following contrast-index values?
1. 0.30
  2. 0.58
  3. 0.65
  4. 0.90
- 2-53. To obtain a gamma of 0.60, you should process this film for what length of time?
1. 3 1/4 minutes
  2. 3 1/2 minutes
  3. 5 minutes
  4. 4 minutes
- 
- Learning Objective: Identify the importance of a chemical quality assurance program.
- 
- 2-54. Which of the following practices is probably the most important factor in a successful chemical quality assurance program?
1. Use extremely accurate modern scientific measuring devices
  2. Take chemical samples and verify their properties on a daily basis
  3. Keep equipment and work areas clean
  4. Directly supervise the preparation of all photographic solutions
- 2-55. What is/are the proper method(s) for determining whether solutions are suitable for processing photographic images?
1. Check them for discoloration
  2. Check them for sedimentation
  3. Check them by chemical analysis
  4. Each of the above
- 2-56. Before sampling a large batch of newly mixed developer, you should wait what minimum time before performing chemical analysis?
1. 5 minutes
  2. 10 minutes
  3. 30 minutes
  4. 2 hours
- 2-57. You are drawing a chemical sample with a pipet from a color film processor. You should draw this sample from what depth of the tank?
1. As close to the surface as possible
  2. About 1 inch below the surface
  3. About 5 inches below the surface
  4. From the bottom of the tank

IN ANSWERING QUESTION 2-53, REFER TO FIGURE 2-10.

- 2-58. You have drawn a solution sample to be analyzed, Before taking a pH measurement, you should shake the sample vigorously.
1. True
  2. False
- 2-59. You should perform which of the following procedures before using a freshly mixed developer?
1. Complete chemical analysis
  2. pH testing
  3. Specific-gravity check
  4. Both 2 and 3 above
- 2-60. When you take a pH measurement of a solution, the temperature of the solution is most critical when the pH is at which of the following values?
1. 10.00
  2. 8.00
  3. 7.00
  4. 6.00
- 2-61. When multiple samples of the same solution are tested, you should standardize a pH meter at which of the following times?
1. Before every reading
  2. After 15 minutes has elapsed only
  3. After four readings only
  4. After 15 minutes has elapsed or after four readings
- 2-62. You have taken a pH reading of four samples of the same developer solution. The readings were 9.38, 9.41, 9.47, and 9.71. What pH value should you record on the control chart?
1. 9.38
  2. 9.41
  3. 9.49
  4. 9.71
- 2-63. You could use a specific gravity reading to verify which of the following chemical properties?
1. Dilution
  2. Activity
  3. Contamination
  4. Shelf life
- 2-64. You have just plotted the gamma from a control strip and the plot exceeds the upper-control limit. Which of the following factors may have caused this condition?
1. Over-replenishment
  2. Excessive agitation
  3. Developer temperature too high
  4. Each of the above

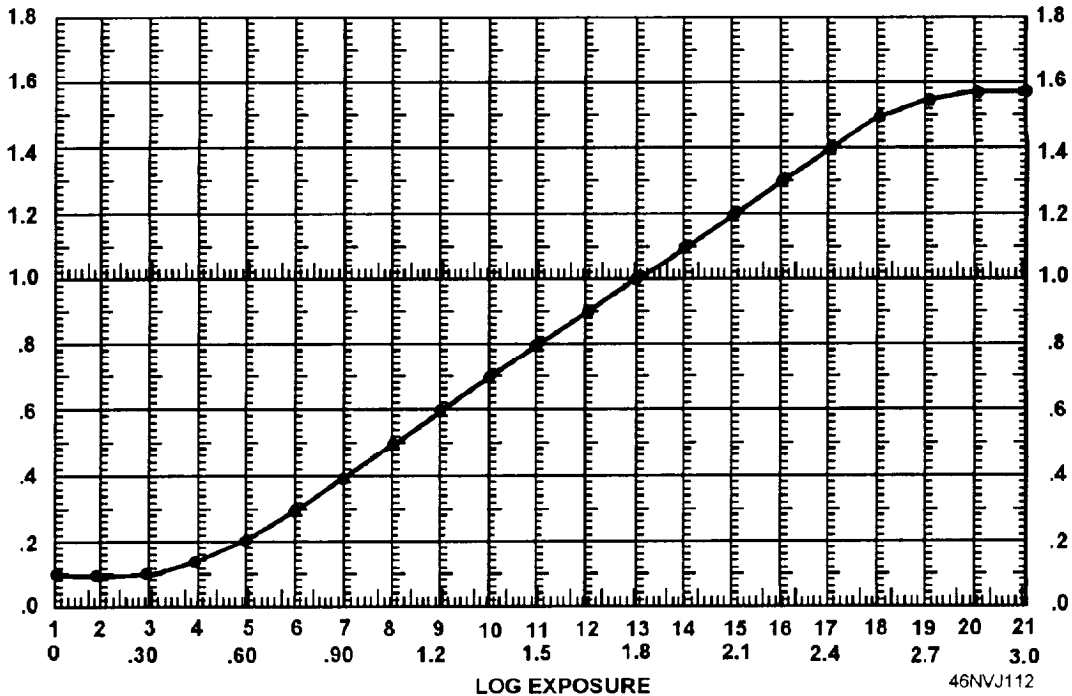

FIGURE 2A

IN ANSWERING QUESTIONS 2-65 AND 2-66, REFER TO FIGURE 2A.

Learning Objective: Identify characteristics of a D log-H curve.

2-65. What step best represents the speed point for ground-pictorial film?

1. 5
2. 11
3. 3
4. 18

2-66. What step best represents the speed point for an aerial film?

1. 1
2. 7
3. 5
4. 4

2-67. From what area of the control strip should you take a reading for gross fog?

1. A
2. B
3. c
4. D

Learning Objective: Recognize factors that may affect a process-control chart. (This objective is continued in assignment 3.)

2-68. Which of the following factors affect(s) gross fog?

1. Development
2. Age
3. Base thickness
4. All of the above

2-69. A process appears to be out of control but may not be. What is this situation called?

1. Variability
2. Deviation
3. Alpha risk
4. Beta risk



FIGURE 2B

IN ANSWERING QUESTION 2-67, REFER TO FIGURE 2B.

2-70. A process appears to be in control but may not be. What is this situation called?

1. Variability
2. Beta risk
3. Alpha risk
4. Deviation

2-71. What five process conditions can a control chart show?

1. Population, variability, deviation, standard error, and standard
2. Contrast index, high density, low density, speed point, and gamma
3. Jump, run, trend, out of control, and normal pattern
4. Gross fog, pH, temperature, fpm, and contrast

# ASSIGNMENT 3

Textbook Assignment: "Photographic Quality Assurance," "Electronic Imaging," and "Aerial Photography." Pages 2-29 through 4-1.

---

Learning Objective (continued) :  
Recognize factors that may affect  
a process-control chart.

---

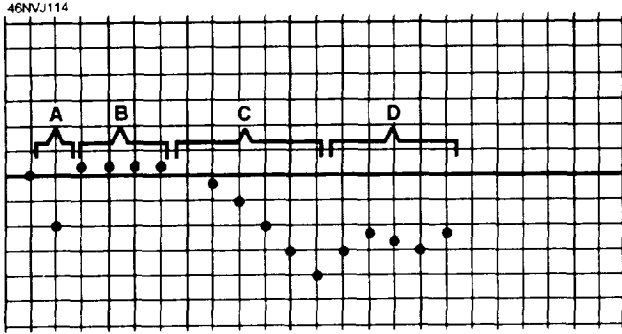

FIGURE 3A

IN ANSWERING QUESTION 3-1 THROUGH 3-4,  
REFER TO FIGURE 3A.

3-1. What segment represents a jump?

1. A
2. B
3. C
4. D

3-2. What segment represents a random pattern?

1. A
2. B
3. C
4. D

3-3. What segment represents a trend?

1. A
2. B
3. c
4. D

3-4. What segment represents a run?

1. A
2. B
3. c
4. D

3-5. You have just processed a control strip and the high-density reading plots above the upper-control limit. What action should you take first?

1. Check the calibration of the densitometer
2. Conduct a complete chemical analysis
3. Stop the process and change the chemicals
4. Review the chemical-mixing records

---

Learning Objective: Recognize procedures used in a color process-monitoring program.

---

3-6. What is the recommended temperature for storing color control strips?

1. 68°F to 75°F
2. 50°F to 68°F
3. 0°F to 32°F
4. 0°F or below

3-7. The manufacturer processes the reference strip that is included with each package of color control strips.

1. True
2. False

3-8. You are establishing a color process-monitoring chart. After processing five control strips, you read and average your data. Your readings exceed the aim values provided by the manufacturer but fall within the action limits. What action should you take?

1. Null the densitometer
2. Arbitrarily adjust the data so it falls on the mean
3. Apply the adjustment tolerances provided by the manufacturer
4. Disregard the data and process, read, and average five more control strips

- 3-9. One of your color process-monitoring charts indicates the past several plots are consistently drifting away from the aim value. Which of the following publications should you consult?
1. The Photo-Lab Index
  2. Chapter 2 of this training manual
  3. The appropriate process-monitoring manual
  4. OPNAVINST 5290.1

---

Learning Objective: Identify various components of an electronic-imaging system.

---

- 3-10. Electronic imaging has what advantage(s) compared to conventional photography?
1. Images can be viewed faster
  2. It is environmentally friendly
  3. Images may be transmitted rapidly
  4. All of the above
- 3-11. What component is the "brain" of a computer?
1. The keyboard
  2. The CPU
  3. The monitor
  4. The software
- 3-12. What type of computer system is used in electronic imaging?
1. Special purpose
  2. Graphical interface
  3. Imaging specific
  4. General purpose
- 3-13. What are the two major components of a computer system?
1. Hardware and software
  2. CPU and output
  3. Input and output
  4. Peripherals and software
- 3-14. Of the following programs, which one is NOT application software?
1. WordPerfect
  2. Adobe Photoshop
  3. DOS
  4. Harvard Graphics

- 3-15. Which of the following components is NOT a section of a CPU?

1. Control
2. Driver
3. Internal storage
4. Arithmetic logic

- 3-16. In a computer system, what component is used for primary storage?

1. Hard drive
2. Floppy disk
3. CPU
4. Magnetic tape

- 3-17. The electronic circuits etched on a silicon chip are known by what term?

1. Bit cell
2. Integrated circuitry
3. Large-scale integration
4. Input/output

- 3-18. Semiconductor storage does not possess which of the following advantages?

1. High reliability
2. Non-volatility
3. Low power consumption
4. Fast internal-processing speeds

- 3-19. What are the two classifications of primary storage?

1. Internal and external
2. Magnetic and floppy
3. ROM and RAM
4. Permanent and temporary

- 3-20. What type of memory is the working memory in a computer system?

1. RAM
2. ROM
3. WORM

---

Learning Objective: Identify methods in which information is transferred throughout a computer system.

---

- 3-21. Of the following peripherals, which one is an output device?

1. Keyboard
2. Scanner
3. Mouse
4. Monitor

- 3-22. Which of the following peripheral devices is connected to a simplex channel?
1. Keyboard
  2. Scanner
  3. Mouse
  4. Printer

- 3-23. The signals that communicate information to control the back-and-forth flow of information between peripheral devices are known by what term?
1. Handshake
  2. Stoppers
  3. Interface
  4. Controllers

- 3-24. What device is used to transmit data over long distances by converting digital signals to audio signals and vice versa?
1. Serial port
  2. Communication port
  3. Translator
  4. Modem

---

Learning Objective: Recognize various uses of software.

---

- 3-25. What type of systems software controls the execution of other programs?
1. Assembler
  2. Operating
  3. Utility
  4. Driver

- 3-26. What type(s) of systems software is/are used as language translators?
1. Assemblers Only
  2. Compilers only
  3. Assemblers and compilers
  4. Utilities

- 3-27. What term describes software written to perform a specific function?
1. Systems
  2. Application
  3. Designer
  4. Task specific

---

Learning Objective: Identify factors that affect the resolution of an electronic-imaging system.

---

- 3-28. What is the smallest picture element displayed on a computer monitor?
1. Raster
  2. Byte
  3. Bit
  4. Pixel

- 3-29. What primary factor determines resolution of an electronic image?
1. The software
  2. The number of pixels in a specific area
  3. The color of the image
  4. The brightness of the monitor screen

- 3-30. One advantage of electronic-imaging technology is that resolution is standardized for all input and output devices.
1. True
  2. False

- 3-31. The process used to determine time when converting an analog waveform into a digital signal is called
1. digitizing
  2. A/D conversion
  3. sampling
  4. quantizing

- 3-32. The conversion of continuous values into distinct numeric values is called
1. digitizing
  2. A/D conversion
  3. sampling
  4. quantizing

- 3-33. What term(s) is/are used to describe the result of the combined process of sampling and quantizing?
1. Digitizing
  2. A/D conversion
  3. Both 1 and 2 above

- 3-34. What term is used to describe the low, objectionable resolution of an electronic image on a display system?
1. Pixelation
  2. Breakup
  3. Softness
  4. Grain



---

Learning Objective: Recognize characteristics of still-electronic cameras.

---

- 3-35. What factor is primarily responsible for the resolution capability of an electronic camera?
1. The storage medium
  2. The camera interface
  3. The speed of the lens
  4. The size of the CCD
- 3-36. In the field mode, a still-video camera uses (a) what number of tracks per image and (b) can record what maximum number of images on a floppy disk?
1. (a) One (b) 25
  2. (a) Two (b) 50
  3. (a) One (b) 50
  4. (a) Two (b) 25
- 3-37. In the frame mode, a still-video camera uses (a) what number of tracks per image and (b) can record what maximum number of images on a floppy disk?
1. (a) One (b) 50
  2. (a) Two (b) 25
  3. (a) One (b) 25
  4. (a) Two (b) 50
- 3-38. A still-video camera uses what type of signal to record images?
1. Digital
  2. Analog
  3. VHF
  4. UHF
- 3-39. Which of the following statements pertaining to still-video technology is NOT true?
1. Images must be converted from an analog to a digital format
  2. Images require less memory than a still-digital image
  3. It provides the lowest resolution of any of the electronic cameras
  4. Images are captured directly in a digital format

- 3-40. Which of the following statements pertaining to still-digital technology is NOT true?
1. Images must be converted from an analog to a digital image
  2. Images require more memory compared to still-video images
  3. Images captured have higher resolution compared to still-video images
  4. Images are captured directly in digital format
- 3-41. How does the effective focal length of the Kodak DCS compare to a conventional 35mm camera?
1. The effective focal lengths are identical
  2. The effective focal length of the DCS is one-half of a conventional 35mm camera
  3. The effective focal length of the DCS is twice that of a conventional 35mm camera
  4. The effective focal length of the DCS is four times that of a conventional 35mm camera

---

Learning Objective: Identify characteristics of various peripheral devices used in electronic imaging.

---

- 3-42. What type of scanner is capable of providing the highest image quality?
1. Rotary drum
  2. Flatbed
  3. Film
- 3-43. What term(s) is/are used for images displayed on the screen of a computer monitor?
1. Bit mapped
  2. Pixel oriented
  3. Raster
  4. All of the above
- 3-44. In reference to a computer monitor, what does the term "pitch" represent?
1. The size of the screen
  2. The overall color cast of the displayed image
  3. The size of a single pixel
  4. The contrast of the displayed image

- 3-45. On a color CRT screen, what three colors compose a single pixel?
1. Yellow, magenta, and cyan
  2. Black, yellow, and blue
  3. Black, cyan, and yellow
  4. Red, green, and blue
- 3-46. What term is used for the duplication of information in a digital file?
1. Redundancy
  2. Compression
  3. Reoccurrence
  4. Repetition
- 3-47. As the compression ratio increases, what happens to the quality of the image?
1. It increases
  2. It decreases
  3. It remains the same
- 3-48. What maximum compression ratio can be used to provide a lossless compression?
1. 5:1
  2. 2:1
  3. 3:1
  4. 4:1
- 3-49. What configuration(s) is/are used to pass information from the computer to the printer to ensure the image is placed properly on the paper?
1. RIP
  2. PDL
  3. Either 1 or 2 above
  4. JPEG
- 3-50. On a thermal-dye transfer printer, a continuous-tone image is created in what way?
1. By blending gaseous color dyes released by donor ribbons and transferring them to the print material
  2. By spraying dyes on the print material and then heating the dyes to make them permanent
  3. By a series of tiny dots that are blended by heating the print material
  4. By dye pigments in the print material that are released when heated
- 3-51. What type of printer provides the highest quality continuous-tone color image?
1. Inkjet
  2. Color copier
  3. Thermal-wax transfer
  4. Thermal-dye transfer
- 3-52. When you are using graphical user-interface software, what element(s) of hardware is/are essential?
1. A mouse
  2. A bit-mapped display
  3. Both 1 and 2 above
  4. A film scanner
- 3-53. When images are manipulated in the editing stage, changes to the original image can be detected readily on hardcopy?
1. True
  2. False
- 
- Learning Objective: Identify the types of aerial photography. (This objective is continued in assignment 4.)
- 
- 3-54. What does the acronym TARPS represent?
1. Total Air Reconnaissance Procurement System
  2. Territorial Air Reproduction Photographic System
  3. Tactical Air Reconnaissance Pod System
  4. Target Arrangement and Reproduction Photo System
- 3-55. An aerial photograph taken from 1,300 feet is considered to be taken from what altitude?
1. Low
  2. Medium
  3. High
- 3-56. What are the three basic categories of aerial photography?
1. Reconnaissance, intelligence, and survey
  2. Gunnery exercises, refueling at sea, and publicity
  3. Construction progress, accident investigation, and ship identification
  4. Vertical, oblique, and air-to-air

3-57. What category of aerial photography is made with the optical axis of the camera lens perpendicular to the ground?

1. Vertical
2. Oblique
3. Air-to-air
4. Reconnaissance

3-58. What category of aerial photography is made with the film plane of the camera parallel to the ground?

1. Oblique
2. Vertical
3. Air-to-air
4. Reconnaissance

3-59. What category of aerial photography is used to provide a uniform scale?

1. Reconnaissance
2. Oblique
3. Air-to-air
4. Vertical

# ASSIGNMENT 4

Textbook Assignment: "Aerial Photography." Pages 4-2 through 4-32.

Learning Objective (continued):  
Identify the types of aerial  
photography.

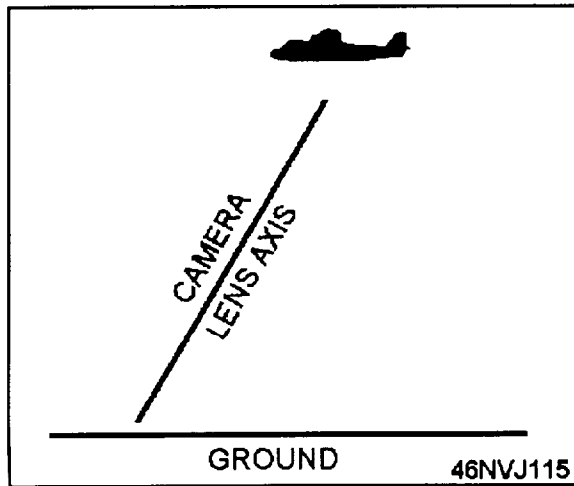

Figure 4A.

IN ANSWERING QUESTIONS 4-1 AND 4-2, REFER TO FIGURE 4A.

4-1. What is the approximate camera depression angle?

1. 60 degrees
2. 45 degrees
3. 20 degrees
4. 0 degrees

4-2. What is the approximate tilt angle?

1. 0 degrees
2. 30 degrees
3. 45 degrees
4. 65 degrees

4-3. What aerial photograph includes the horizon in the image?

1. Vertical
2. Low oblique
3. High oblique

4-4. What aerial photograph is used for orientation purposes?

1. High oblique
2. Low oblique
3. Vertical
4. Air-to-air

4-5. High-oblique photographs are made from high altitudes, while low-oblique photographs are made from low altitudes.

1. True
2. False

4-6. What type of aerial photography should be made of a small target when only one print is required?

1. Stereo
2. Mosaic
3. Strip
4. Pinpoint

4-7. What type of aerial photography should be used to make a series of overlapping photographs of a long, narrow highway?

1. Stereo
2. Mosaic
3. Strip
4. Pinpoint

4-8. What minimum number of views is required to produce a stereo effect from aerial photographs?

1. One
2. Two
3. Three
4. Four

4-9. One large photograph composed of several overlapping strips pieced together is known as what type of aerial photography?

1. Stereo
2. Mosaic
3. Strip
4. Pinpoint

4-10. Two photographs mounted and ready for stereo viewing are known by what term?

1. Stereo
2. Stereopair
3. Stereogram
4. Stereoset

4-12. What type of aerial photography is used to make maps or charts?

1. Reconnaissance
2. Intelligence
3. Cartographic
4. Mosaic

---

Learning Objective: Recognize applications of TARPS.

---

QUESTIONS 4-13 THROUGH 4-19 INVOLVE TARPS.

4-13. It is designed for use with what type of aircraft?

1. P-3
2. C-130
3. F-18
4. F-14

4-14. What number of photographic sensors are used in a full configuration?

1. One
2. Two
3. Three
4. Four

4-15. What person controls camera operation?

1. The Photographer's Mate
2. The pilot
3. The naval flight officer
4. The aircrewman

4-16. The panoramic camera is in what area of the pod?

1. Center
2. Front
3. Rear
- 4.

4-17. The frame camera is capable of what number of positions?

1. One
2. Two
3. Three
4. Four

4-18. The infrared reconnaissance set is in what location?

1. Front
2. Center
3. Rear

4-19. What official normally originates the requirement for EEI reconnaissance?

1. The Commander, Naval Intelligence
2. The Secretary of the Navy
3. The Director of Special intelligence
4. The Task Force Commander

---

Learning Objective: Identify film and filter combinations used for aerial photography.

---

4-20. What type of aerial camera is designated KE?

1. Reconnaissance
2. Mapping
3. Scope recording
4. Still picture

4-21. What weather phenomena causes haze by concentrating and trapping particles in the air?

1. Temperature inversion
2. Thermal shimmer
3. Thermal convection

4-22. What photographic filter is most effective for cutting through haze?

1. Blue
2. Green
3. Red
4. Yellow

4-23. What type of film reproduces the most ground detail through haze?

1. Tech. Pan
2. Infrared
3. Kodacolor
4. Ektachrome

4-24. While viewing a black-and-white aerial photograph, you notice the vegetation in the image appears white. What is the most reasonable explanation for this occurrence?

1. Vegetation always appears white in black-and-white aerial images
2. Heavy haze existed when the photographs were taken and prevented green light from reaching the camera
3. Color film was used to make the pictures, and it was developed in a black-and-white developer
4. Infrared film was used to make the images

- 4-25. What color filter should you use to expose IR black-and-white film?
1. Red
  2. Green
  3. Blue
  4. Yellow
- 4-26. What color filter should you use to expose color IR film?
1. Red
  2. Green
  3. Blue
  4. Yellow
- 4-27. You should NOT develop Kodak Ektachrome film in which of the following processes?
1. E-6
  2. ME-4
  3. EAR-5
  4. E-4
- 4-28. What color filters are used to control haze in aerial photography?
1. Green and blue
  2. Red and green
  3. Blue and yellow
  4. Yellow and red
- 4-29. In black-and-white aerial photography, which of the following filters provides the greatest haze penetration?
1. No. 8
  2. No. 15
  3. No. 25
  4. No. 2B

---

Learning Objective: Recognize procedures used for taking aerial photographs.

---

- 4-30. You are taking a low-oblique aerial photograph from a high altitude. What is the best method for determining your camera exposure setting?
1. Take a light meter reading from the ground before boarding the aircraft and use this setting
  2. Use the substitution method by using a light meter reading from a gray aircraft engine or wing
  3. Take an air-to-ground light meter reading and use this setting
  4. Set the aperture to f/5.6 and do not vary from this setting

- 4-31. You are using a map with a scale of 1:15,000. Therefore, 1 inch on the map represents what number of feet on the ground?
1. 1,250
  2. 5,000
  3. 7,500
  4. 15,000
- 4-32. What is the scale of an image shot from an altitude of 10,000 feet with a camera having a 3-inch focal-length lens?
1. 1:10,000
  2. 1:20,000
  3. 1:30,000
  4. 1:40,000
- 4-33. You should have what percentage of overlap between exposures when taking aerial photographs for a strip?
1. 20%
  2. 40%
  3. 60%
  4. 80%
- 4-34. When overlapping aerial photographs for a mosaic map, you should use what section of each photograph?
1. The center 40 percent
  2. The center 60 percent
  3. The outer 40 percent
  4. The outer 60 percent
- 4-35. When you are making mosaic maps, what is the side lap between each strip?
1. 20 percent
  2. 40 percent
  3. 60 percent
  4. 80 percent

---

Learning Objective: Demonstrate the calculations necessary for an aerial mapping mission.

---

IN ANSWERING QUESTIONS 4-36 THROUGH 4-48, USE THE FOLLOWING INFORMATION:

- a. An area to be mapped photographically is 15 nautical miles north and south by 25 nautical miles east and west.
- b. Forward overlap required is 60 percent; side lap 40 percent.
- c. Photography scale is 1:17,000.

- d. Camera lens focal length is 7 inches; film format is 4.5 by 4.5 inches.
- e. Aircraft airspeed is 320 knots. There is no wind.
- f. Ground coverage per shot is 6,400 feet.
- g. Scale of mission planning chart is 1:40,500.
- 4-36. What altitude is required for this mapping mission?
1. 23,800 feet
  2. 15,950 feet
  3. 10,000 feet
  4. 5,950 feet
- 4-37. At the required scale, 1 inch on the negative represents what number of feet on the ground?
1. 313 feet
  2. 1,417 feet
  3. 3,750 feet
  4. 9,955 feet
- 4-38. The image of a building on the negative measures 1.75 inches long. What is the actual length of the building?
1. 1,452 feet
  2. 2,489 feet
  3. 3,750 feet
  4. 4,800 feet
- 4-39. With the required overlap, what is the GGF?
1. 640 feet
  2. 1,280 feet
  3. 2,560 feet
  4. 5,120 feet
- 4-40. With the required overlap, what is the GGS?
1. 1,840 feet
  2. 2,840 feet
  3. 3,840 feet
  4. 4,840 feet
- 4-41. In what direction should the aircraft fly?
1. North only
  2. North or south
  3. East only
  4. East or west
- 4-42. The area being photographed is what number of feet (a) long and (b) wide?
1. (a) 152,000 (b) 91,200
  2. (a) 262,000 (b) 92,400
  3. (a) 363,000 (b) 93,800
  4. (a) 462,000 (b) 94,600
- 4-43. What number of photographs is required per flight strip?
1. 59
  2. 60
  3. 64
  4. 66
- 4-44. What total number of flight strips is required?
1. 15
  2. 25
  3. 35
  4. 45
- 4-45. What total number of photographs is required?
1. 1,600
  2. 2,600
  3. 3,600
  4. 4,600
- 4-46. You should draw the flight lines what distance apart on the planning chart?
1. 1.13 inches
  2. 2.26 inches
  3. 3.72 inches
  4. 4.40 inches
- 4-47. What is the required interval between exposures, in seconds?
1. 1.1
  2. 2.3
  3. 3.5
  4. 4.7
- 4-48. What number of inches on the mosaic map represents 1,000 feet on the ground?
1. 0.70
  2. 0.90
  3. 1.10
  4. 1.30
- 
- Learning Objective: Identify procedures used to compose aerial photography.
-

- 4-49. When shooting an aerial assignment, it is important for you to communicate with the pilot at which of the following times?
1. During preflight
  2. During flight
  3. During postflight
  4. Each of the above
- 4-50. When composing an aerial photograph, you have the most control over which of the following factors?
1. Subject placement
  2. Lighting
  3. The moment the picture is shot
  4. Camera-to-subject distance
- 4-51. What are the "picture areas" of a low-oblique photograph?
1. Foreground, target area, background, and sky
  2. Foreground, target area, and background
  3. Target area, background, and sky
- 4-52. When shooting a high-oblique aerial photograph, you should divide the image area into what number of sections to achieve proper composition?
1. One
  2. Two
  3. Three
  4. Four
- 4-53. Which of the following actions should you take to reduce image blurring caused by camera movement?
1. Have the pilot reduce the throttle
  2. Use a fast shutter speed
  3. Prevent your upper body and camera from touching the aircraft
  4. All of the above
- 4-54. Which of the following lenses should you select for taking an air-to-air photograph of an F-18?
1. 135mm
  2. 50mm
  3. 25mm
  4. 15mm



# ASSIGNMENT 5

Textbook Assignment: "Aerial Photography" and "Supply and Logistics." Pages 4-33 through 5-30.

---

Learning Objective: Identify uses for maritime surveillance photography.

---

- 5-1. Of the following rigs, which one is NOT a basic rigging pattern for maritime surveillance photography?
1. Special interest
  2. Full
  3. Modified full
  4. Normal standard
- 5-2. What view of a ship provides information as to the length of the ship?
1. Bow quarter
  2. Beam
  3. Stern quarter
  4. Stern
- 5-3. What maritime surveillance photographic rig should you use to photograph a "never before seen" potential enemy ship?
1. Special interest
  2. Quick
  3. Normal standard
  4. Full
- 5-4. A quick rig consists of what number of views?
1. One
  2. Two
  3. Three
  4. Four
- 5-5. You are using a 16mm motion-picture camera for shooting an aerial mission. Which of the following fps rates should you use?
1. 12 fps
  2. 16 fps
  3. 24 fps
  4. 48 fps

Learning Objective: Recognize aerial film processing procedures.

---

- 5-6. What document provides you with the necessary processing information to make preparations for processing TARPS film?
1. Mission planning form
  2. Maintenance action form
  3. Photographic job order
- 5-7. Which of the following personnel are responsible for preparing TARPS sensors for a mission?
1. Photo lab
  2. CVIC
  3. Line maintenance
  4. Mission planning
- 5-8. You are evaluating TARPS film exiting the dryer section of a processor. You notice a dark spider-weblike pattern on several of the frames. What is the most probable cause of this defect?
1. Shutter banding
  2. Vacuum malfunction
  3. Camera light leak
  4. Static electricity
- 5-9. What portion(s) of the characteristic curve should you use to duplicate aerial film?
1. Straight line only
  2. Straight line and shoulder only
  3. Straight line and toe only
  4. Straight line, shoulder, and toe
- 5-10. The trigradient tone reproduction method of duplicating aerial film is based on what number of tone-control curves?
1. One
  2. Two
  3. Three
  4. Four

---

Learning Objective: Recognize elements of the Navy supply system and their relative importance.

---

5-11. Within the Navy, there are what number of stock points for the Navy Supply System?

1. Nine
2. Eight
3. Seven
4. Six

5-12. What does the acronym "FISC" represent?

1. Federal Inquiry Service Center
2. Federal Industrial Supply Center
3. Fleet Investigative Service Command
4. Fleet and Industrial Supply Command

5-13. Which of the following organizations provides the majority of office supplies to the Navy?

1. ASO
2. DLA
3. GSA
4. ISO

---

Learning Objective: Identify elements of a national stock number.

---

5-14. What is the FSC number for a still-picture camera?

1. 6710
2. 6720
3. 6730
4. 6750

5-15. What is the FSC number for a roller-transport film processor?

1. 6710
2. 6720
3. 6730
4. 6740

5-16. A national stock number contains what number of digits?

1. Nine
2. Seven
3. Five
4. Four

5-17. What number of characters make up a Navy item control number?

1. 20
2. 15
3. 13
4. 7

5-18. Material that is stocked at a Navy stock point but not in the Federal Catalog System is assigned what type of identification number?

1. Navy item control
2. Local item control
3. Material control code
4. Special material identification Code

5-19. The material identification number 6720-LL-791-9296 is what type of number?

1. Navy item control
2. Local item control
3. Material control code
4. Special material identification code

---

Learning Objective: Recognize publications used for supply requisitions.

---

5-20. To cross-reference a manufacturer's part number for a camera mechanism to an NSN, you should consult what publication?

1. *Management List-Navy*
2. *Afloat Shopping Guide*
3. *Consolidated Master Cross-Reference List*
4. *Photographic Equipment List*

5-21. To order Navy publications for your imaging facility, you should consult which of the following references?

1. *Naval Imaging Management and Operations Manual*
2. *Manual of Naval Photography*
3. *DoD Consolidated Federal Supply Catalog*
4. *Navy Stock List of Publications and Forms*

5-22. As a Photographer's Mate, you will use what part of the Navy Stock List the most?

1. ASO E-6789
2. C-0001
3. P-2002
4. 00-35QP

- 5-23. What volume of the *GSA Supply Catalog* contains current prices for NSN items?
1. 1
  2. 2
  3. 3
  4. 4
- 5-24. The "I Cog Catalog" has what NAVSUP number?
1. C-0001
  2. E-6789
  3. P-2002
  4. 00-35QP
- 5-25. What section of NAVSUP P-2002 provides an alphabetic listing of publications and forms?
1. I
  2. II
  3. III
  4. IV
- 5-26. Current microfiche editions of NAVSUP P-2002 are issued at what intervals?
1. Annually
  2. Semiannually
  3. Quarterly
  4. Monthly
- 5-27. What type of number should be used by purchasing officers to ensure that all of the requirements for a particular type of material are met?
1. Specification
  2. Drawing
  3. Identification
  4. I cog
- 5-28. What source provides an illustrated parts breakdown (IPB) for equipment used in an imaging facility?
1. The Navy Supply Depot
  2. The Naval Media Center
  3. The ASO
  4. The manufacturer
- 
- Learning Objective: Recognize documents and procedures required for procuring supply items.
- 
- 5-29. What supply-computerized system is used aboard aircraft carriers?
1. SNAP I
  2. SNAP II
  3. UADPS
- 5-30. What document is used to purchase open-purchase items in a computerized-supply system?
1. DD Form 1149
  2. DD Form 1250-1
  3. DD Form 1250-2
  4. DD Form 1348
- 5-31. What form is used as a shipping and invoice document?
1. DD Form 1149
  2. DD Form 1250-1
  3. DD Form 1250-2
  4. DD Form 1348
- 5-32. What action takes place when a material obligation validation (MOV) request is neglected?
1. The requisition is placed on back order
  2. The requisition is canceled
  3. The requisition is resubmitted automatically
  4. A double order of the requisition results
- 5-33. You have ordered 400 rolls of 35mm film. However, the supply point only shipped 380 rolls and canceled the remainder of the order. What term applies to this transaction?
1. Exception status
  2. Cancellation
  3. Material obligation validation
  4. One-hundred percent supply status
- 5-34. What is the UND of a routine requisition?
1. A
  2. B
  3. C
  4. D
- 5-35. Your command is assigned an F/AD of III. A routine requisition has what priority?
1. 03
  2. 06
  3. 11
  4. 13
- 5-36. What MILSTRIP publication covers procedures afloat?
1. NAVSUP P-437
  2. NAVSUP P-485
  3. NAVSUP P-1149
  4. NAVSUP P-1348

5-37. What type of requisition is used to "buy" material from SERVMART?

1. A procurement requisition
2. A SERVMART chit
3. An MVO

5-38. Which of the following forms may be used for requisitioning material from SERVMART?

1. DD Form 1149
2. DD Form 1250/9-1
3. DD Form 1348
4. Either 2 or 3 above

5-39. What form is used to order Navy departmental directives?

1. DD Form 1149
2. DD Form 1205
3. DD Form 1250/9-1
4. DD Form 1348

5-40. What document identifier is assigned to a requisition follow-up?

1. AF1
2. A1F
3. 1AF
4. FA1

5-41. What maximum dollar amount may be expended from an imprest fund for emergency purchases?

1. \$150
2. \$300
3. \$1,000
4. \$2,500

---

Learning Objective: Identify procedures used for conducting inventory of supplies and controlled equipage.

---

5-42. What NAVSUP form should be used to reflect the current inventory of stock on hand?

1. NAVSUP 10700
2. NAVSUP 1348
3. NAVSUP 1149
4. NAVSUP 1114

IN ANSWERING QUESTIONS 5-43 THROUGH 5-45, USE THE FOLLOWING INFORMATION.

Your imaging facility uses 75 rolls of a given film per month. The safety level is 4 months, while the stocking objective is 6 months. The order and shipping time is 1 month.

5-43. What is the operations level in (a) months and (b) number of rolls of film?

1. (a) 2 (b) 100
2. (a) 3 (b) 150
3. (a) 2 (b) 150
4. (a) 3 (b) 100

5-44. What is the high level in the number of (a) rolls of film and (b) months?

1. (a) 525 (b) 7
2. (a) 500 (b) 5
3. (a) 525 (b) 5
4. (a) 500 (b) 7

5-45. What is the low limit for number of rolls of film?

1. 400
2. 375
3. 350
4. 325

5-46. A projection enlarger is in what classification of plant property?

1. 1
2. 2
3. 3
4. 4

5-47. What are the NAVSUP form numbers for "custody cards"?

1. 1348 and 1149
2. 1114 and 767
3. 766 and 306
4. 460 and 306

5-48. What individual within a command is responsible for maintaining the original custody cards?

1. The supply officer
2. The division officer
3. The production petty officer
4. The supply petty officer

5-49. Once it has begun, a controlled-equipage inventory must be completed within what number of days?

1. 7
2. 14
3. 30
4. 60

- 5-50. What is the ultimate goal of the MLSR program?
1. To recover stolen property
  2. To improve physical security
  3. To identify the individual accountable
  4. To replace lost property
- 5-51. You should refer to what instruction for guidance pertaining to the MLSR program?
1. SECNAVINST 5510.1
  2. SECNAVINST 5500.4
  3. OPNAVINST 5290.1
  4. NAVSUPINST 1114.1
- 5-52. What form should be used to prepare an MLSR report?
1. SF-364
  2. SF-361
  3. NAVSUP Form 766
  4. DD Form 200
- 5-53. What individual is responsible for initiating a Report of Survey?
1. The supply petty officer
  2. The leading chief petty officer
  3. The commanding officer
  4. The officer accountable
- 5-54. Which of the following individuals can NOT be appointed as a financial liability officer?
1. A commissioned officer
  2. A warrant officer
  3. A master chief petty officer
  4. An accountable officer

